



Catálogo de Instrumental Odontológico



Av. Isabel la catolica y Madrid Edf Isabella plaza

Boxdentalecuador@gmail.com

(593) 0982234568 - (02) 392300

1

BISTURIS



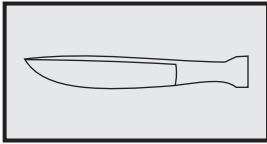

Scalpels



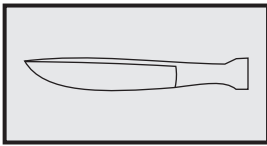

Scalpels



Solid



1/1

1
DC25-003-01



1/1

3
DC25-003-03



1/1

5
DC25-003-05



1/1

7
DC25-003-07



1/1

9
DC25-003-09



1/1

10
DC25-003-10



1/1

12
DC25-003-12



1/1

14
DC25-003-14



1/1

16
DC25-003-16



1/1

18
DC25-003-18

DC25-003-01 DC25-003-64 Knives with Solid Handle

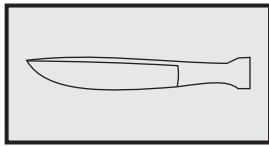

Scalpels

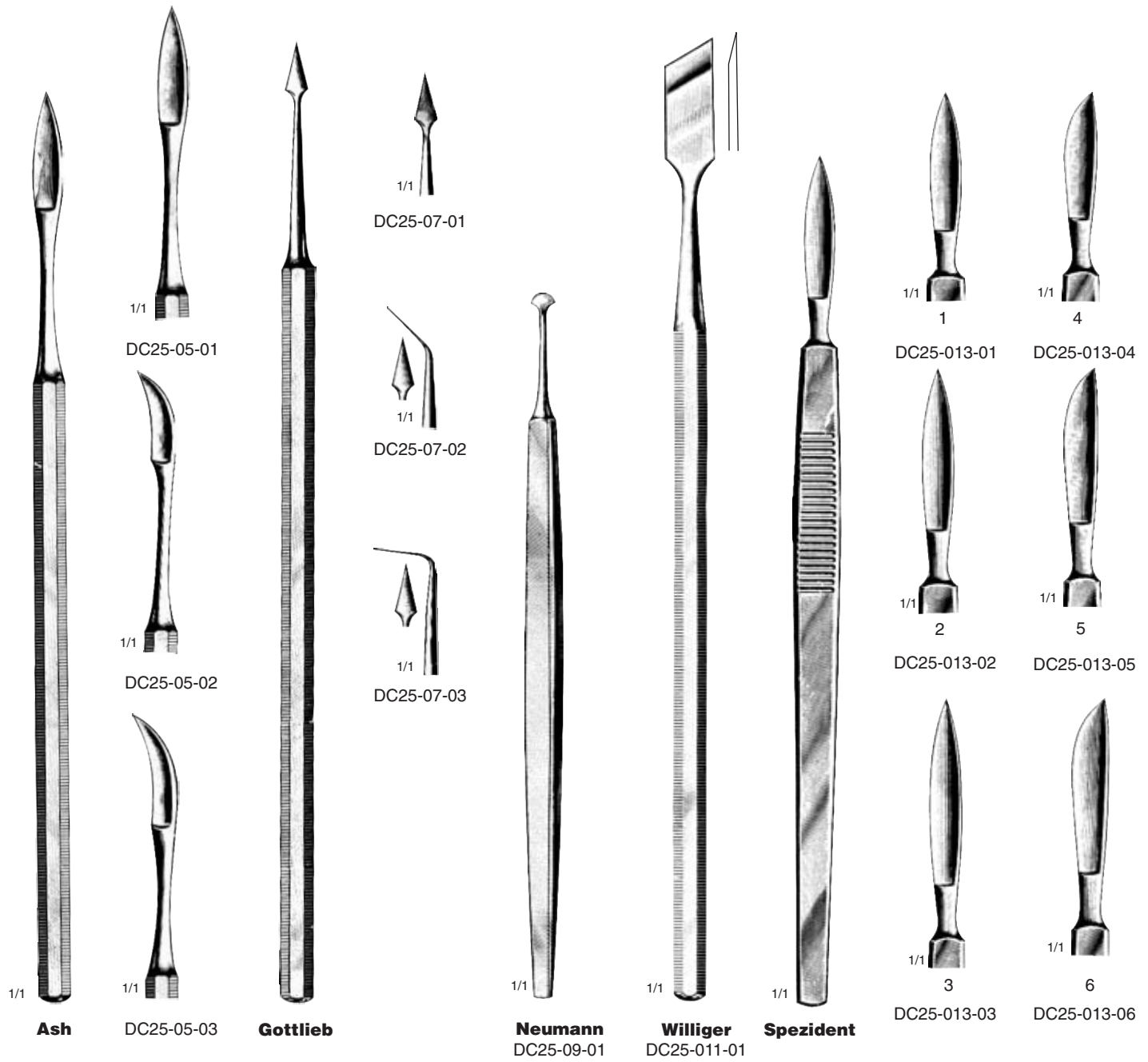

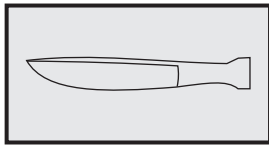

Scalpels



1/1

Solid No.3
DC25-015-03



1/1

Solid No.3
DC25-017-03



1/1

Solid No.4
DC25-019-04



1/1

Solid No.4-3
DC25-021-43



1/1

Solid No.7
DC25-023-07



1/1

Solid No.7K
DC25-025-07

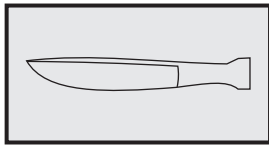

Scalpels

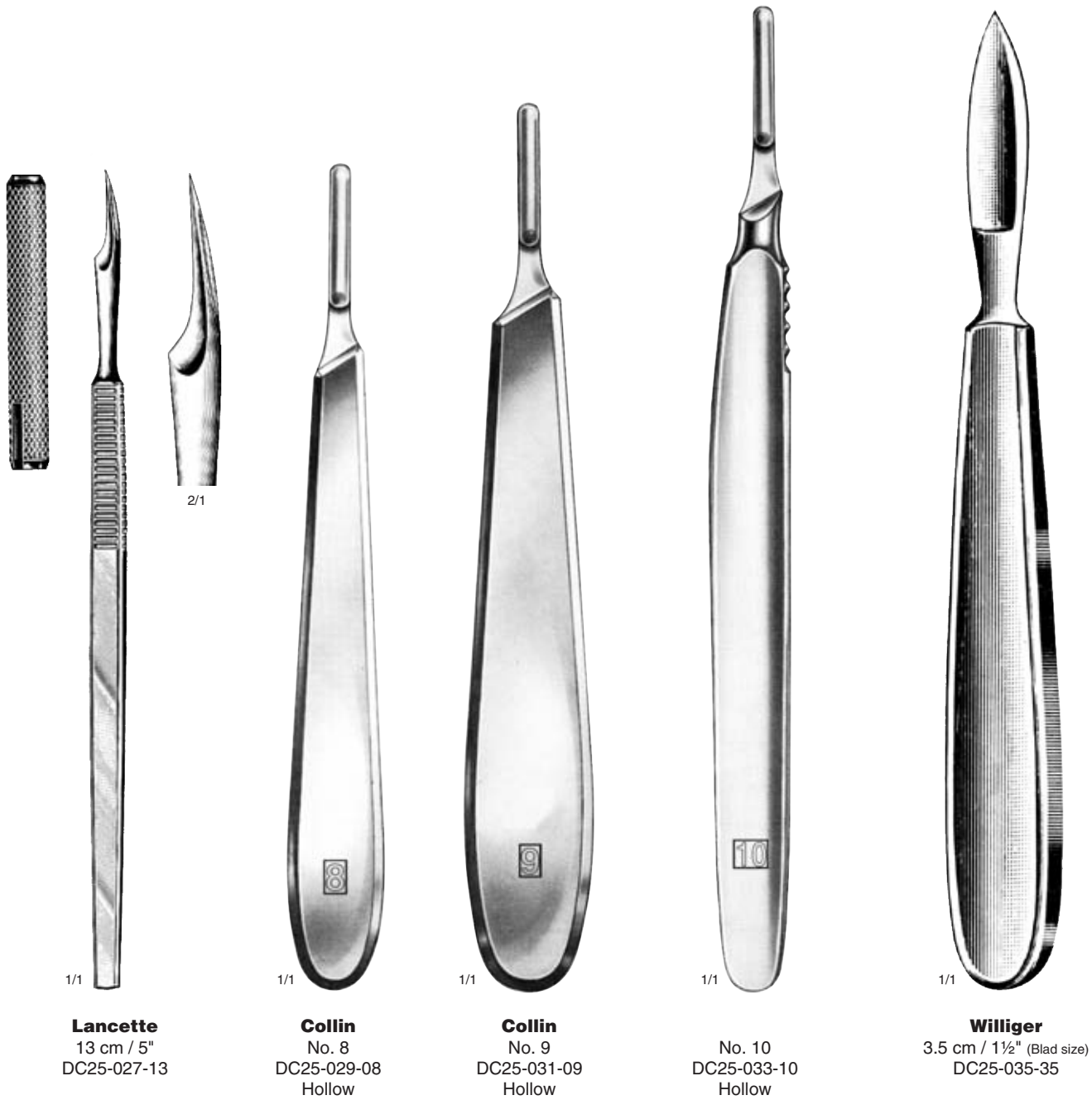

2

TIJERAS

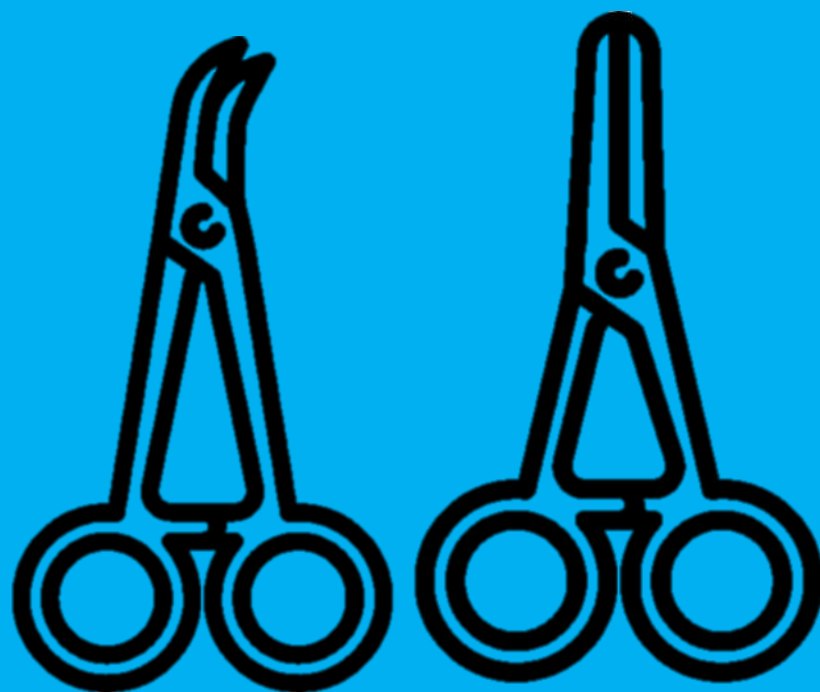

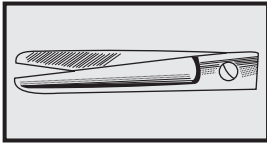

Operating scissors



Standard

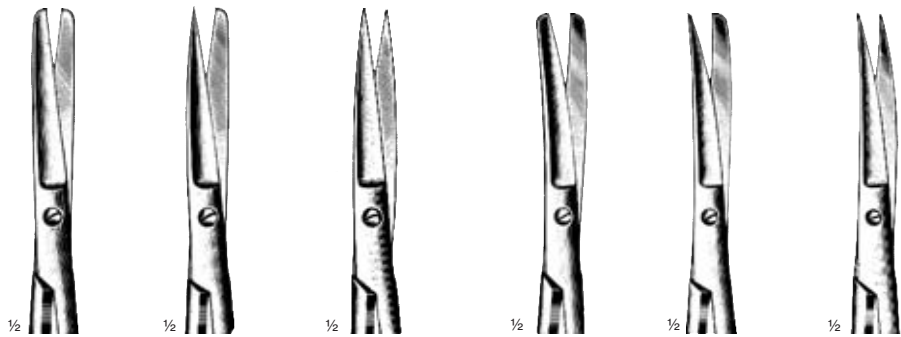

Straight

Curved

cm	in						
10.5	4¼	DC26-001-10	DC26-003-10	DC26-005-10	DC26-007-10	DC26-009-10	DC26-011-10
11.5	4½	DC26-001-11	DC26-003-11	DC26-005-11	DC26-007-11	DC26-009-11	DC26-011-11
13	5	DC26-001-13	DC26-003-13	DC26-005-13	DC26-007-13	DC26-009-13	DC26-011-13
14.5	5½	DC26-001-14	DC26-003-14	DC26-005-14	DC26-007-14	DC26-009-14	DC26-011-14
15.5	6	DC26-001-15	DC26-003-15	DC26-005-15	DC26-007-15	DC26-009-15	DC26-011-15
16.5	6½	DC26-001-16	DC26-003-16	DC26-005-16	DC26-007-16	DC26-009-16	DC26-011-16



Graziil

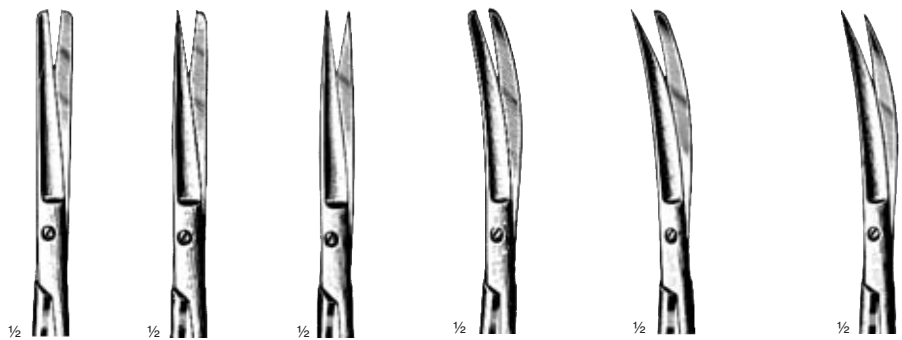

Straight





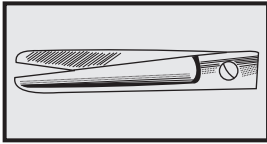

Curved

cm	in						
13	5	DC26-013-13	DC26-015-13	DC26-017-13	DC26-019-13	DC26-021-13	DC26-023-13
14.5	5½	DC26-013-14	DC26-015-14	DC26-017-14	DC26-019-14	DC26-021-14	DC26-023-14



1/2







Metzenbaum
14.5 cm / 5 1/2"

					
Straight			Curved		
DC26-025-14	DC26-027-14	DC26-029-14	DC26-031-14	DC26-033-14	DC26-035-14



1/2

Metzenbaum-Nelson
18 cm / 7"

					
Straight			Curved		
DC26-037-18	DC26-039-18	DC26-041-18	DC26-043-18	DC26-045-18	DC26-047-18

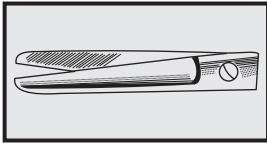

Fine Operating Scissors



Kelly
16 cm / 6½"
DC26-049-16

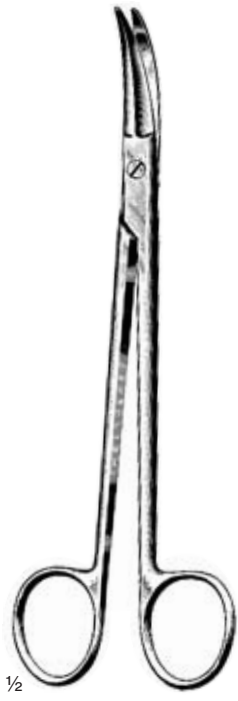

Prince
18 cm / 7"
AE 02-051-18

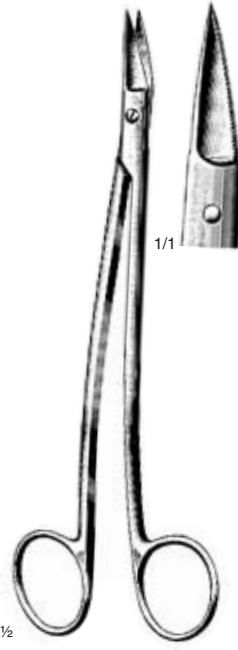

Dean
17 cm / 6¾"
DC26-053-17



12 cm / 4¾"



DC26-055-12



DC26-057-12



DC26-059-12



DC26-061-12

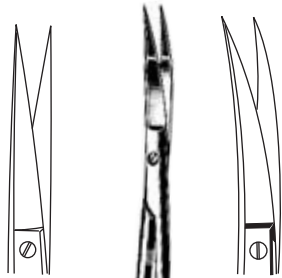

13 cm / 5"
DC26-065-13



13 cm / 5"
DC26-067-13



12 cm / 4¾"
DC26-069-12



12 cm / 4¾"
DC26-071-12

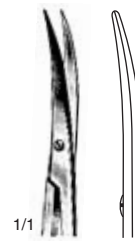

11.5 cm / 4½"
DC26-075-11
Curved

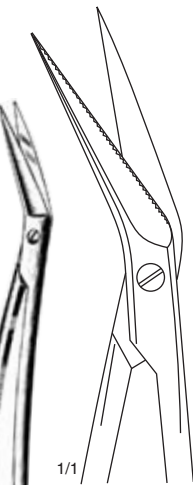

1/1

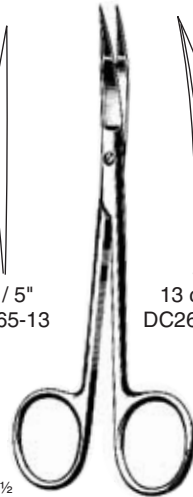

Wagner
13 cm / 5"

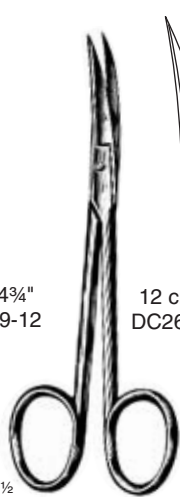

Wagner
12 cm / 4¾"

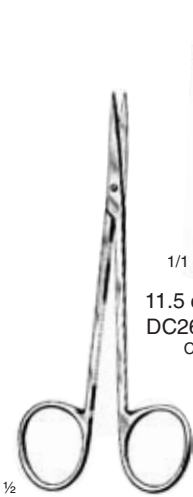

11.5 cm / 4½"
DC26-073-11
Straight

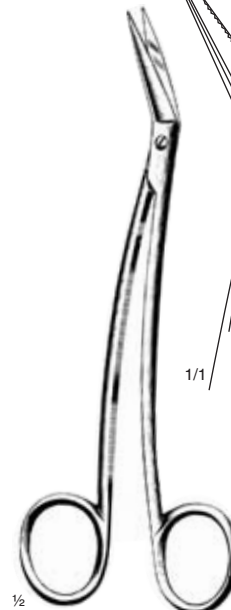

Locklin
16 cm / 6¼"
DC26-077-16
Saw edge

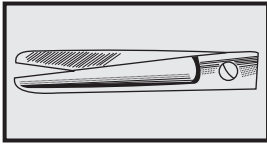

Fine Operating Scissors



cm	in	Straight	Curved	Straight	Curved	Straight	Curved
9	3½			DC26-083-09	DC26-085-09		
10	4			DC26-083-10	DC26-085-10		
11	4½	DC26-079-11	DC26-081-11	DC26-083-11	DC26-085-11	DC26-087-11	DC26-089-11
11.5	4½						

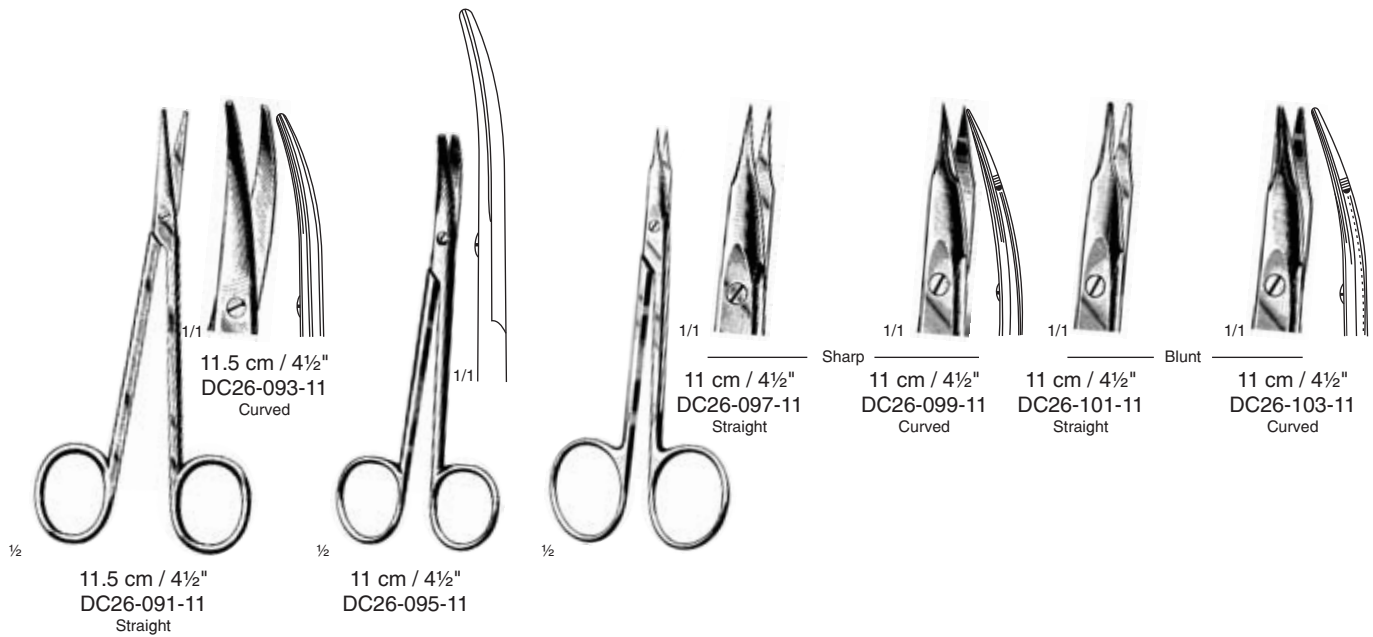

DC26-083-09 DC26-089-11 Iris Scissors

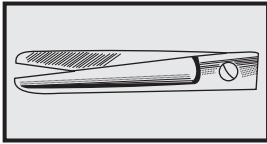

Ligature Scissors



1/2
13 cm / 5"
DC26-105-13



1/2
Spencer
9 cm / 3 1/2"
DC26-107-09

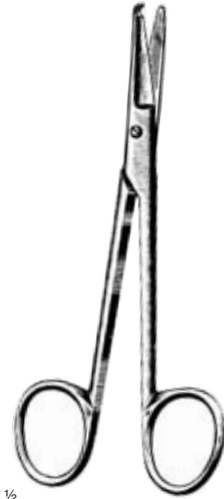

1/2
Spencer
13 cm / 5"
DC26-109-13



1/2
Buck
14.5 cm / 5 1/2"
DC26-111-14
18 cm / 7"
DC26-111-18



1/2
12 cm / 4 3/4"
DC26-113-12



1/2
Littauer
14 cm / 5 1/2"
DC26-115-14

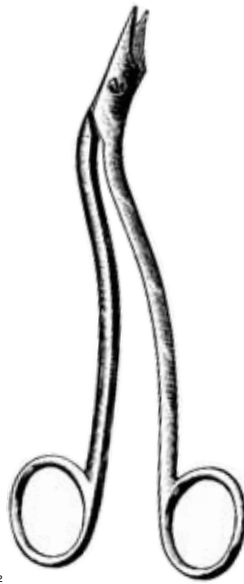

1/2
Heath
15 cm / 6"
DC26-117-15



1/2
Shoemaker-Loth
13 cm / 5"
DC26-119-13



1/2
Eiselsberg
12 cm / 4 3/4"
DC26-121-12

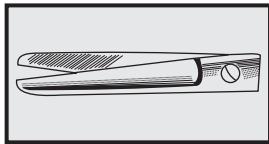

Universal
12 cm / 4 3/4"
DC26-123-12
Saw edge

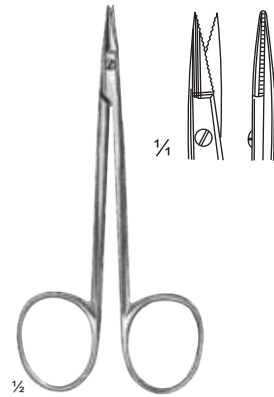

10 cm / 4"
DC26-125-10
Saw edge

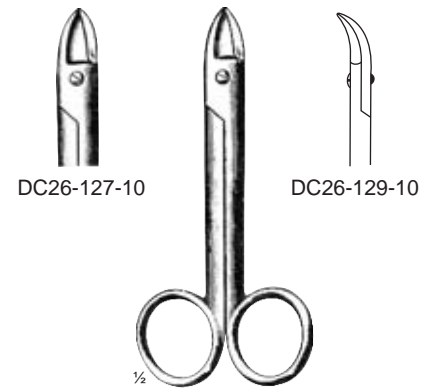

Beebee
10 cm / 4"
Blunt



Beebee
10 cm / 4"
DC26-131-10
Sharp

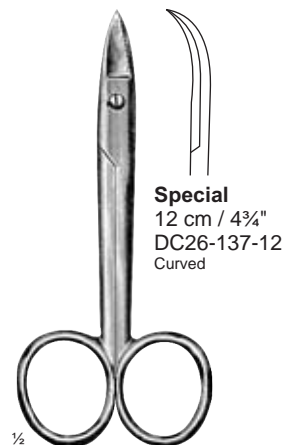

Special
12 cm / 4 3/4"
DC26-137-12
Curved
Saw edge

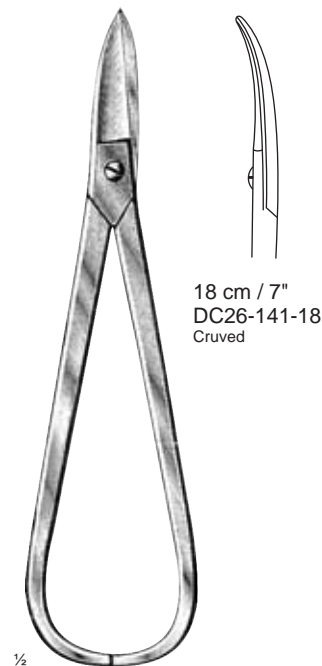

18 cm / 7"
DC26-141-18
Curved
Straight

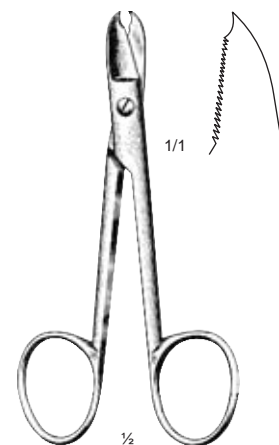

12 cm / 4 3/4"
DC26-143-12
Saw edge

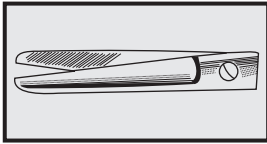

Various Scissors



10.5 cm / 4"
DC26-145-10
Saw edge

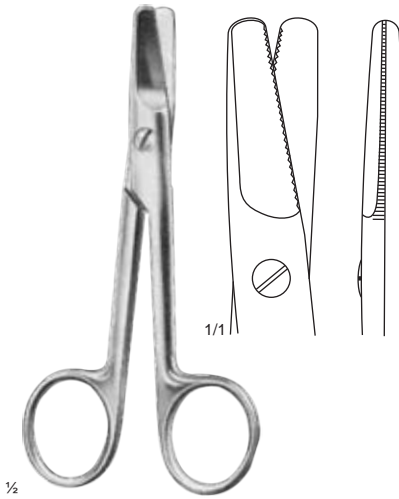

Harvey
12.5 cm / 5"
DC26-147-12



Sanvenero
14 cm / 5½"
DC26-149-14
Straight

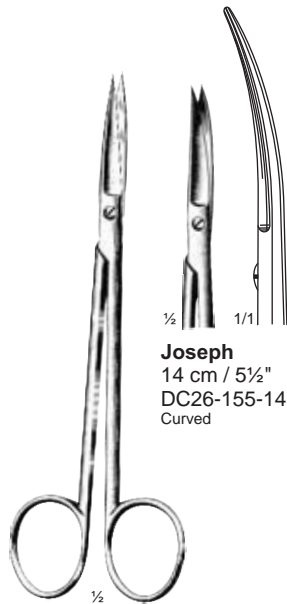

Joseph
14 cm / 5½"
DC26-155-14
Curved



Lexer
16cm/6 ¼"
DC26-157-16
21cm/8 ½"
DC26-159-21

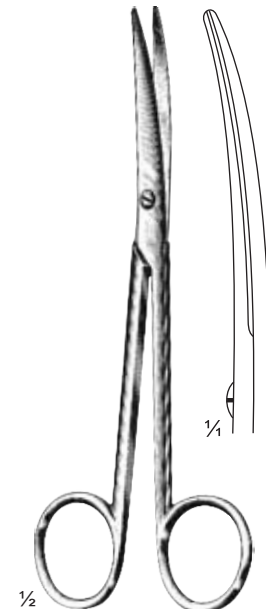

Lexer
16cm/6 ¼"
DC26-161-16
21cm/8 ½"
DC26-163-21

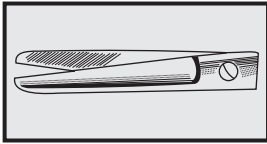

Gum Scissors & Gum Guillotine Forceps



1/2

Metzenbaum
14.5 cm / 5 1/2"
DC26-165-14
saw edge, straight



1/2

Metzenbaum
14.5 cm / 5 1/2"
DC26-167-14
saw edge, curved

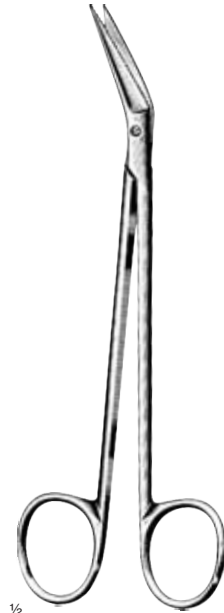

1/2

Locklin
16 cm / 6 1/4"
DC26-173-16
saw edge

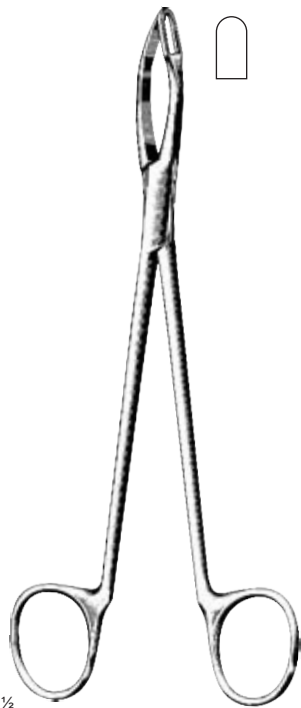

1/2

Modell USA
18 cm / 7"
DC26-175-18

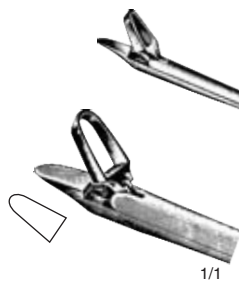

1/1



1/2

Tomati
19 cm / 7 1/2"
DC26-177-19

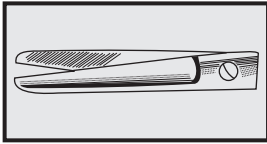

Scissors



10 cm / 4"
DC26-179-10

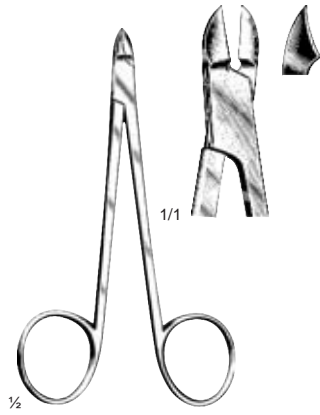

10.5 cm / 4 1/4"
DC26-181-10

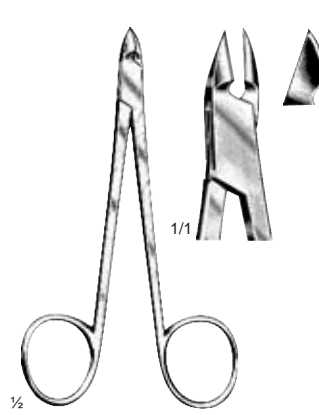

10.5 cm / 4 1/4"
DC26-183-10

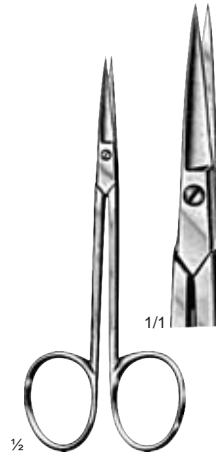

10 cm / 4"
DC26-185-10

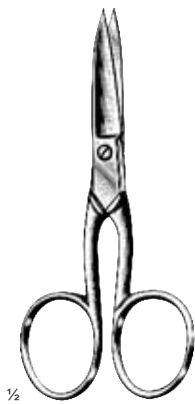

9 cm / 3 1/2" DC26-187-09
10 cm / 4" DC26-187-10
11 cm / 4 1/2" DC26-187-11

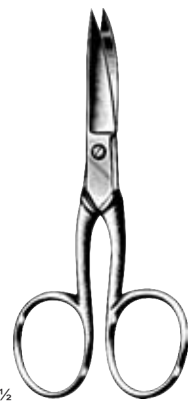

9 cm / 3 1/2" DC26-189-09
10 cm / 4" DC26-189-10
11 cm / 4 1/2" DC26-189-11

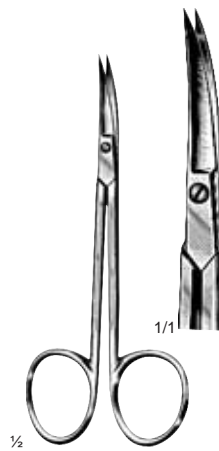

10 cm / 4" DC26-191-10
11 cm / 4 1/2" DC26-191-11

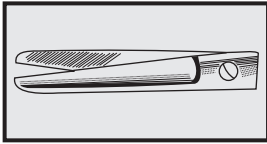

Scissors with tungsten carbide inserts

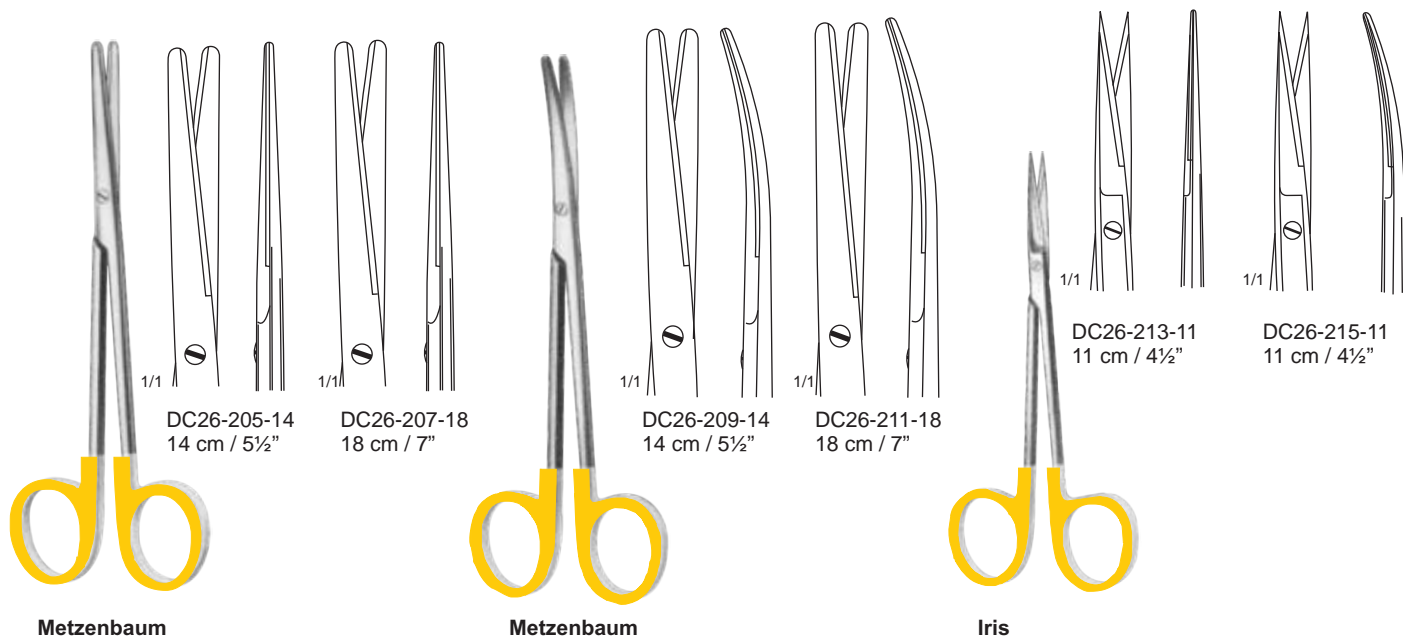
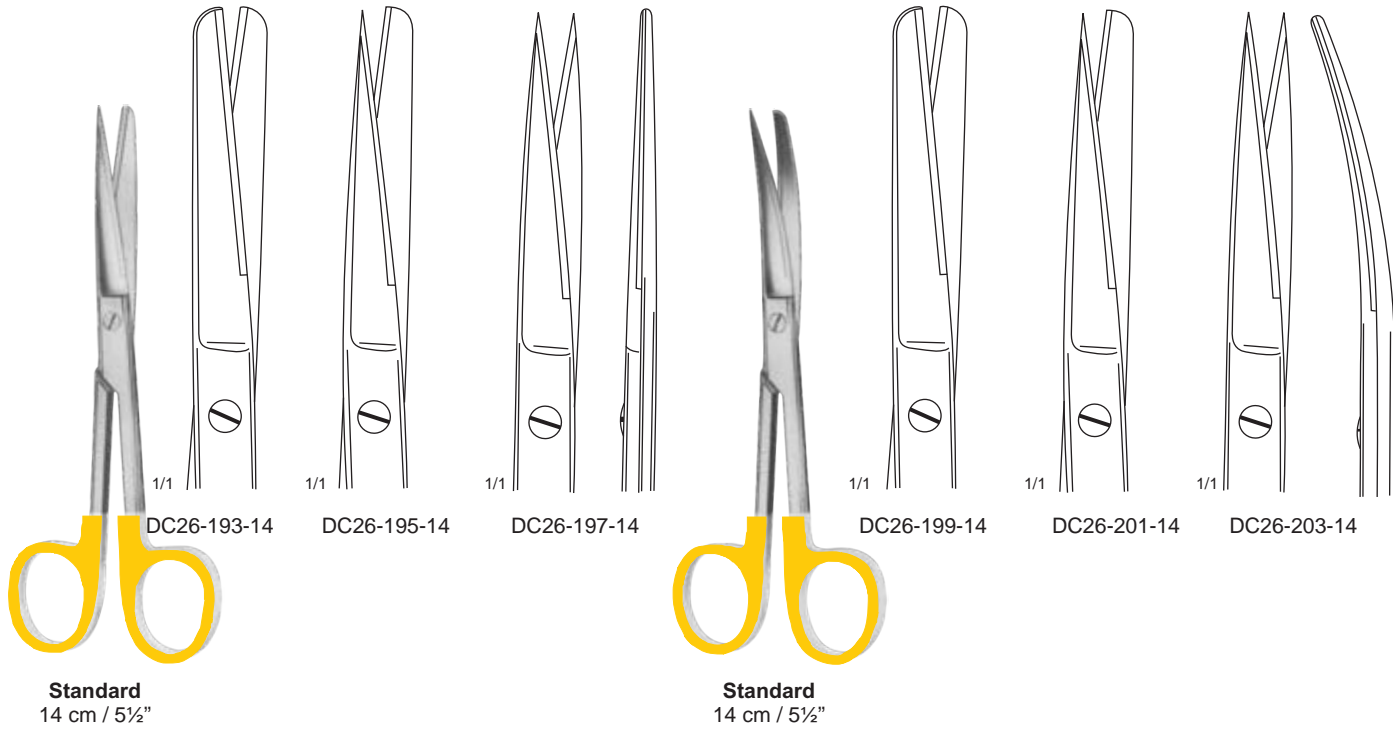

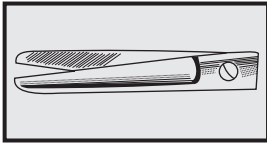

Scissors with tungsten carbide inserts

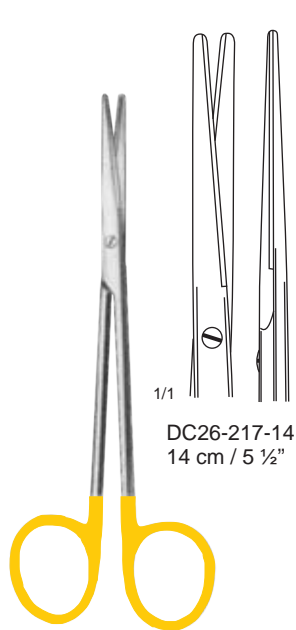

1/1
DC26-217-14
14 cm / 5 1/2"

Metzenbaum-Fino

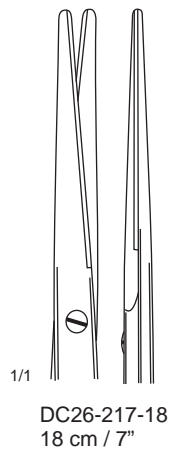

1/1
DC26-217-18
18 cm / 7"



1/1
DC26-217-20
20 cm / 8"

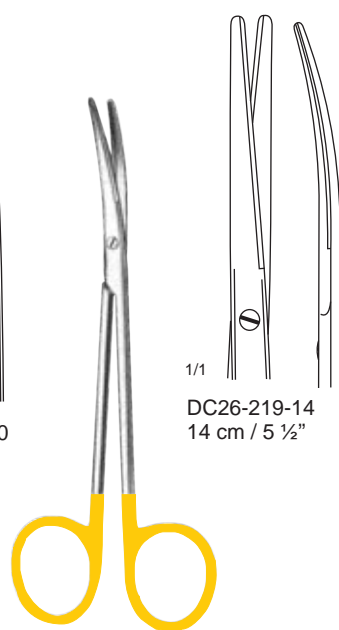

1/1
DC26-219-14
14 cm / 5 1/2"

Metzenbaum-Fino

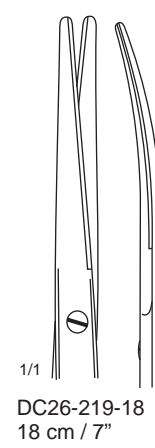

1/1
DC26-219-18
18 cm / 7"



1/1
DC26-219-20
20 cm / 8"

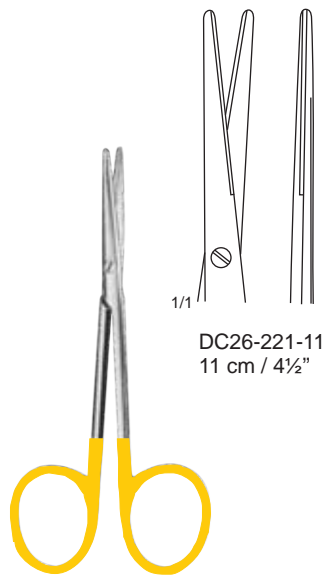

1/1
DC26-221-11
11 cm / 4 1/2"

Strabismus

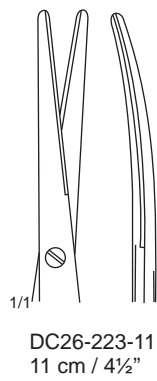

1/1
DC26-223-11
11 cm / 4 1/2"

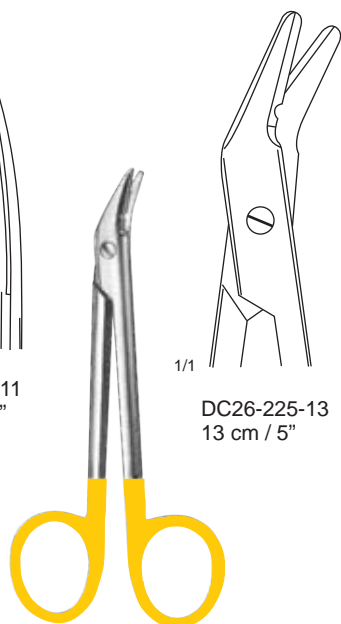

1/1
DC26-225-13
13 cm / 5"

Wire Cutter

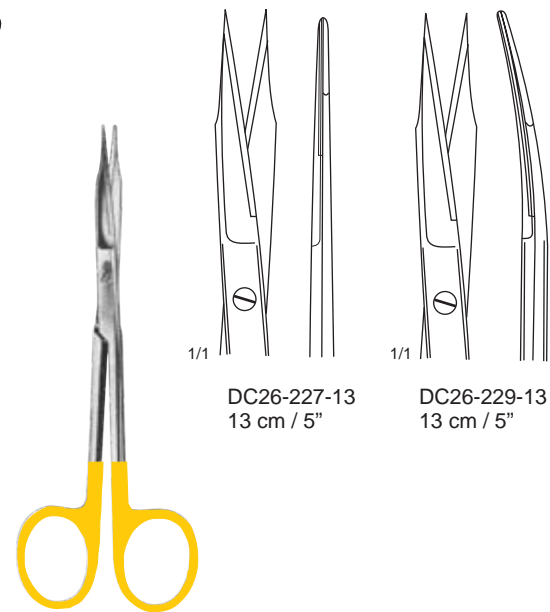

1/1
DC26-227-13
13 cm / 5"

Goldman Fox

1/1
DC26-229-13
13 cm / 5"

3

PINZAS
PARA
VENDAJES



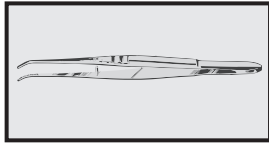

Dressing Forceps



cm	in.	Standard	Standard	Standard	Standard	USA. Mod.	USA. Mod.
10.5	4¼	DC27-001-10	DC27-003-10	DC27-005-10	DC27-007-10		
14.5	5½	DC27-001-14	DC27-003-14	DC27-005-14	DC27-007-14	DC27-009-14	DC27-011-14
16	6½	DC27-001-16	DC27-003-16	DC27-005-16	DC27-007-16		
18	7	DC27-001-18	DC27-003-18	DC27-005-18	DC27-007-18	DC27-009-18	DC27-011-18

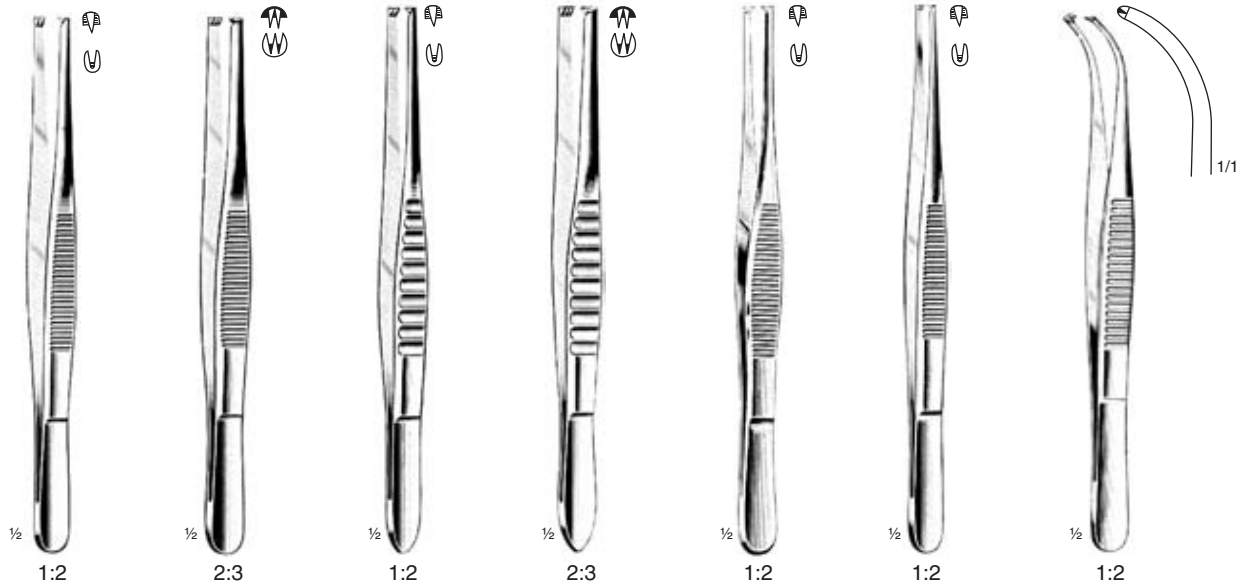

cm	in.							
11	4½	DC27-013-11	DC27-015-11					
14	6	DC27-013-14	DC27-015-14	DC27-017-14	DC27-019-14	DC27-021-14	DC27-023-14	DC27-025-14
16	7	DC27-013-16	DC27-015-16					
18	8	DC27-013-18	DC27-015-18	DC27-017-18	DC27-019-18			

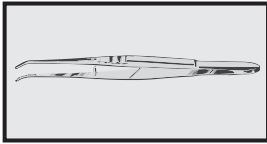

Dressing Forceps

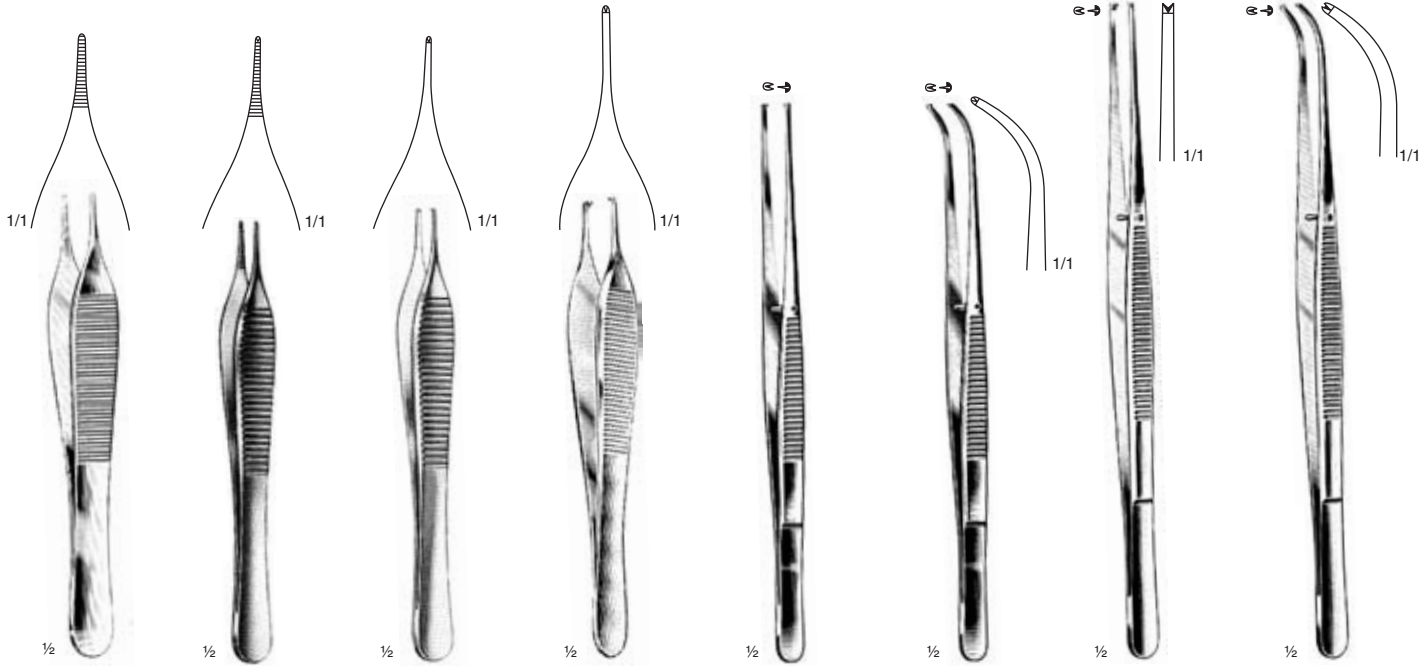

Adson
12 cm / 4¾"
DC27-026-12

Micro-Adson
12 cm / 4¾"
DC27-027-12

Micro-Adson
12 cm / 4¾"
DC27-029-12
1:2

Adson
12 cm / 4¾"
DC27-031-12
15 cm / 6"
DC27-031-15
1:2

Semken
12.5 cm / 5"
DC27-033-12
15 cm / 6"
DC27-033-15
1:2

Semken
12.5 cm / 5"
DC27-035-12
15 cm / 6"
DC27-035-15
1:2

Taylor
17.5 cm / 7"
DC27-037-17
1:2

Taylor
17.5 cm / 7"
DC27-039-17
1:2



Taylor
17.5 cm / 7"
DC27-041-17
1:2



Semken
12.5 cm / 5"
DC27-043-12
15.5 cm / 6"
DC27-043-15



Semken
12.5 cm / 5"
DC27-045-12
15.5 cm / 6"
DC27-045-15



Potts-smith
18 cm / 7"
DC27-047-18
21 cm / 8¼"
DC27-047-21



Potts-smith
18 cm / 7"
DC27-049-18
21 cm / 8¼"
DC27-049-21



Adson-Brown
12 cm / 4¾"
DC27-051-12

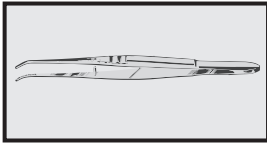

Splinter Forceps

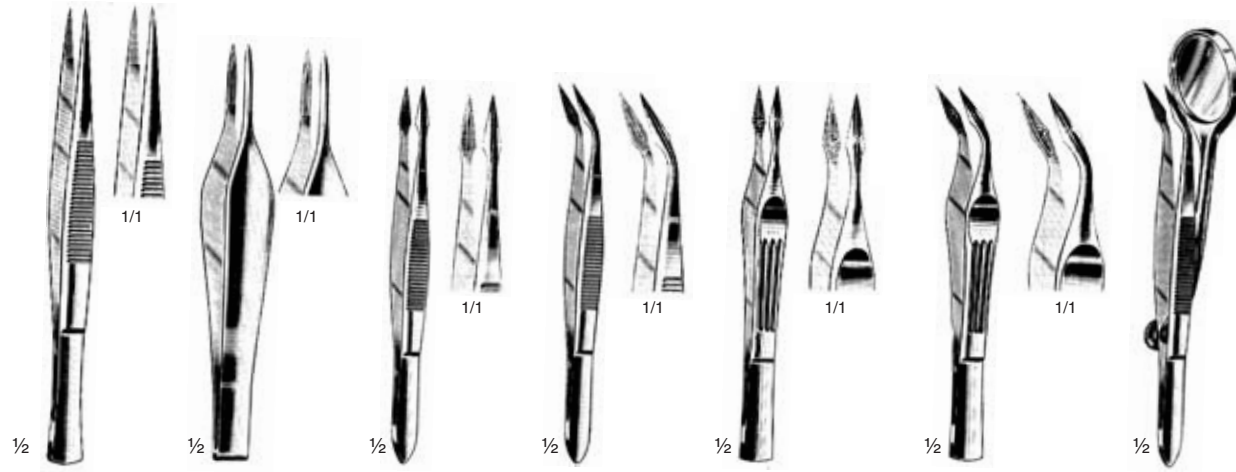

	Feilchenfeld		Hunter		Walter-Carmalt	
12.5cm / 4¾"	7.5cm / 3"	10.5cm / 4¼"	10.5cm / 4¼"	10.5cm / 4¼"	10.5cm / 4¼"	12.5cm / 4¾"
DC27-053-12	DC27-055-07 9cm / 3½"	DC27-057-10	DC27-0759-10	DC27-061-10	DC27-063-10	DC27-065-12
	DC27-055-09					

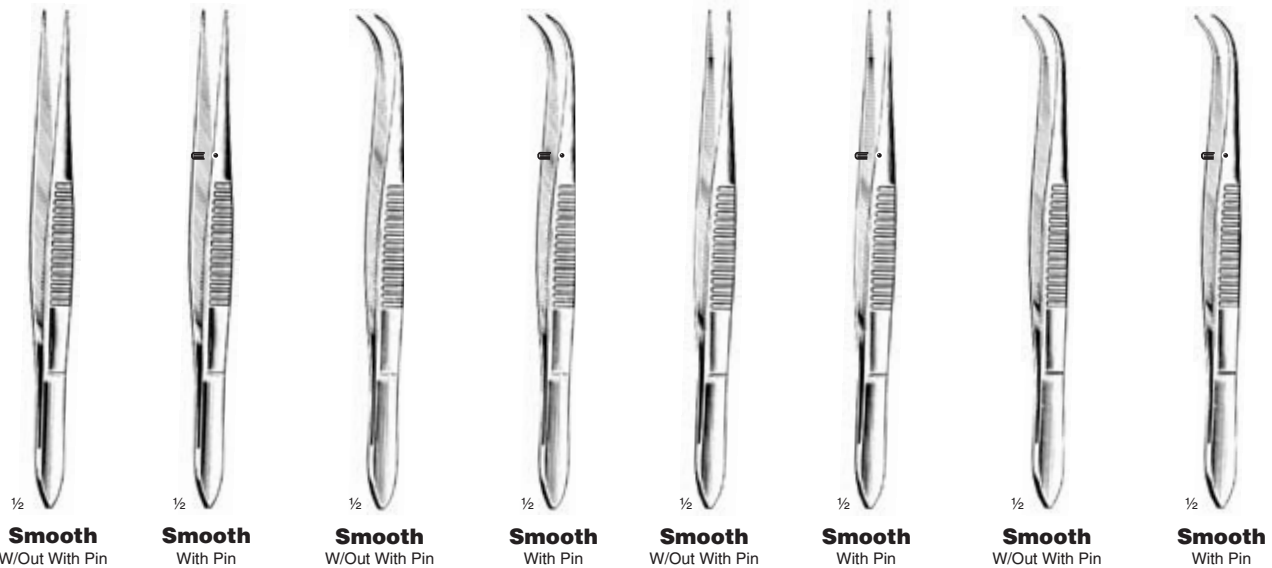

cm	in								
8	3¼	DC27-067-08	DC27-069-08	DC27-071-08	DC27-073-08	DC27-075-08	DC27-077-08	DC27-079-08	DC27-081-08
9	3½	DC27-067-09	DC27-069-09	DC27-071-09	DC27-073-09	DC27-075-09	DC27-077-09	DC27-079-09	DC27-081-09
10.5	4¼	DC27-067-10	DC27-069-10	DC27-071-10	DC27-073-10	DC27-075-11	DC27-077-10	DC27-079-10	DC27-081-10
11.5	4½	DC27-067-11	DC27-069-11	DC27-071-11	DC27-073-11	DC27-075-12	DC27-077-11	DC27-079-11	DC27-081-11
12.5	5	DC27-067-12	DC27-069-12	DC27-071-12	DC27-073-12		DC27-077-12	DC27-079-12	DC27-081-12

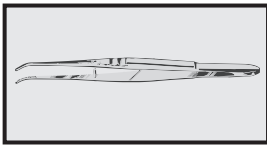

2/3

London Collage
15 cm / 6"

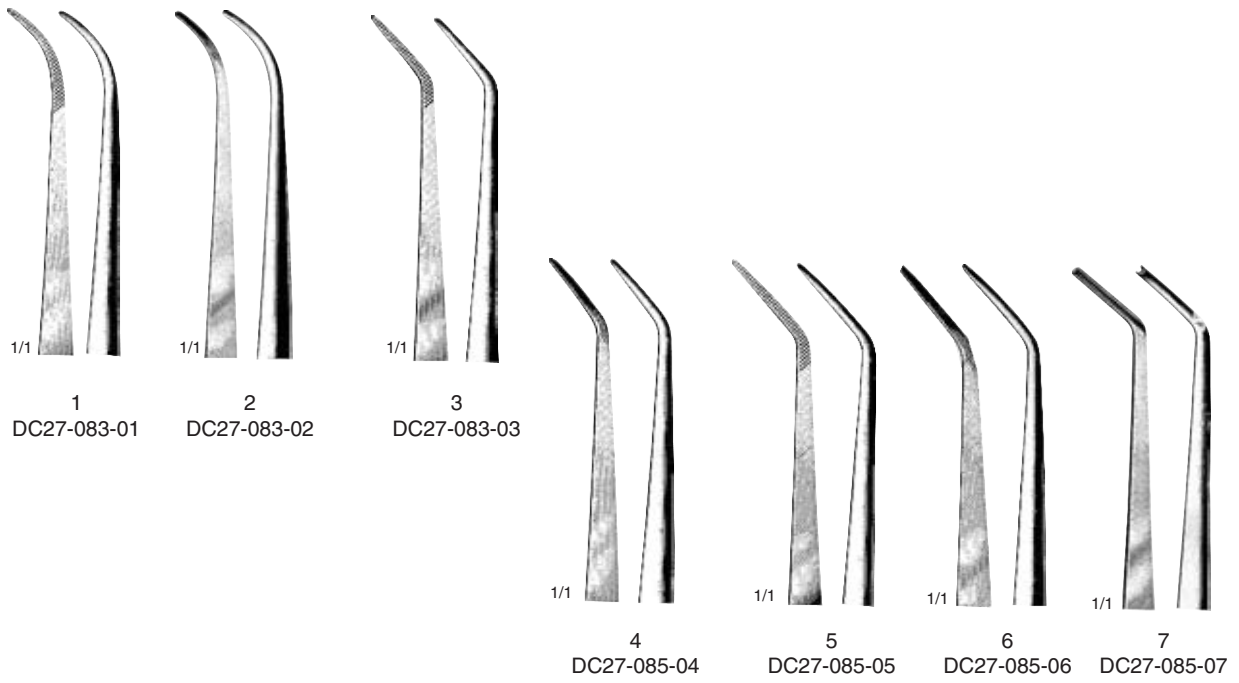

2/3

London Collage
15 cm / 6"

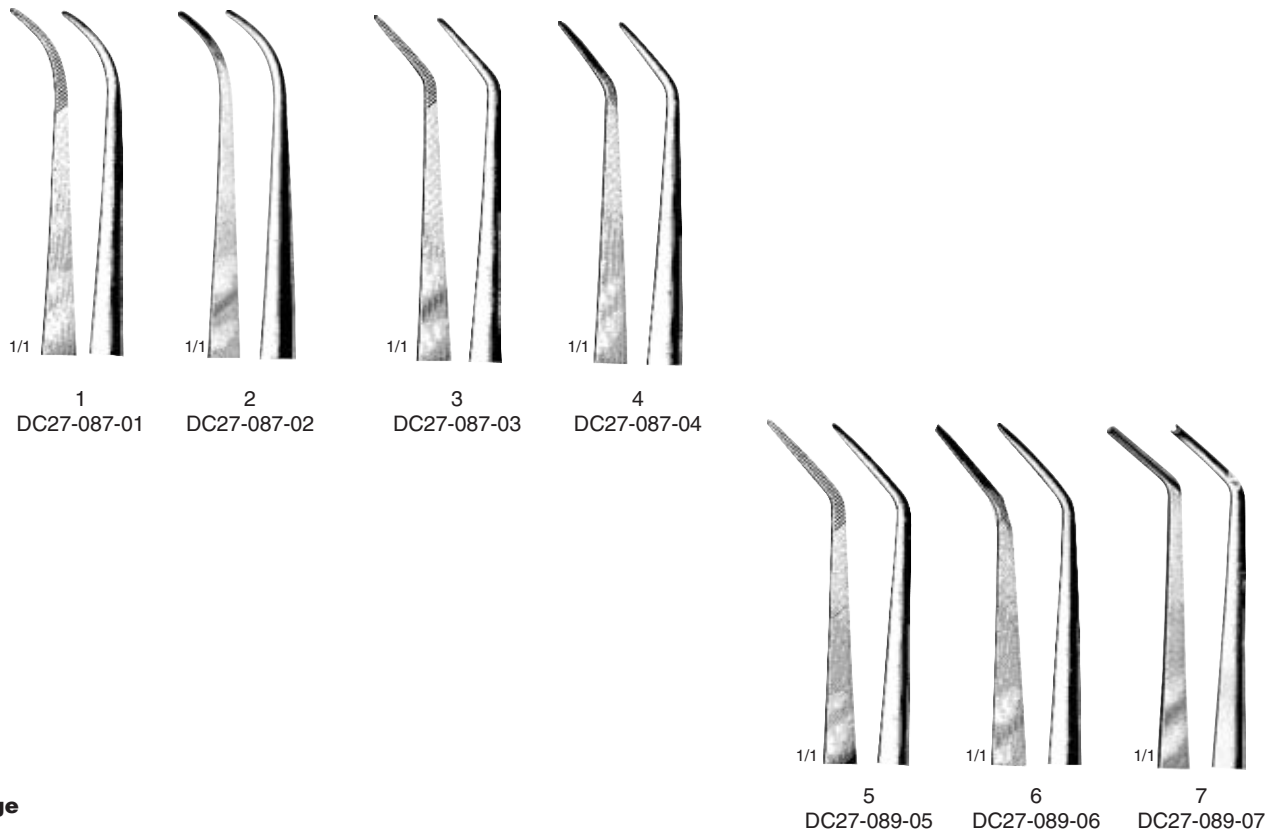

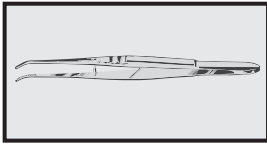

Dental Forceps



2/3

Flagg
15 cm / 6"

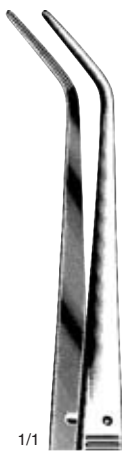

1/1

1
DC27-091-01



1/1

2
DC27-091-02



1/1

3
DC27-091-03



1/1

4
DC27-091-04



1/1

5
DC27-091-05



1/1

6
DC27-091-06

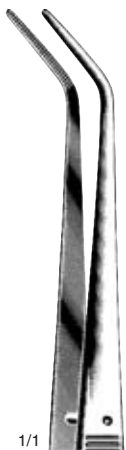

1/1

1
DC27-093-01



1/1

2
DC27-093-02



1/1

3
DC27-093-03



1/1

4
DC27-093-04



1/1

5
DC27-093-05



1/1

6
DC27-093-06



2/3

Meriam
15 cm / 6"

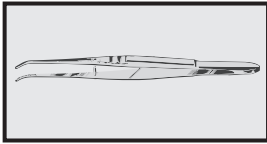

Landgraf
15 cm / 6"



1/1
1
DC27-095-01



1/1
2
DC27-095-02



1/1
3
DC27-095-03

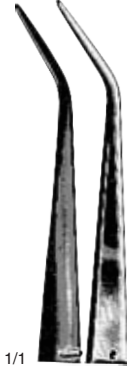

1/1
4
DC27-095-04



2/3
Perry
12.5 cm / 5"
DC27-097-12



1/1



2/3
Perry
12.5 cm / 5"
DC27-099-12



2/3
Zeibe
12.5 cm / 5"
DC27-101-12



1/2
Mod Martin
Suture & Membrane Forceps

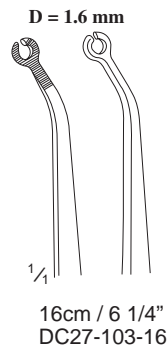

D = 1.6 mm
1/4
16cm / 6 1/4"
DC27-103-16

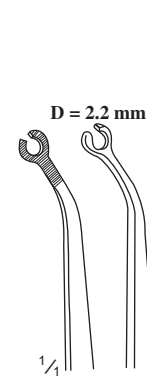

D = 2.2 mm
1/4
16cm / 6 1/4"
DC27-105-16



1/2
Mod Martin
Suture & Membrane Forceps

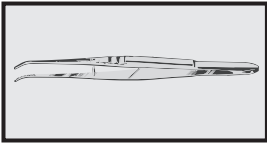

Bracket Holders, Temporary Teeth Forceps



$\frac{2}{3}$
13.5cm/5¼"
DC27-109-01



$\frac{2}{3}$
13.5cm/5¼"
DC27-111-01



$\frac{2}{3}$
14cm/5½"
DC27-113-01



Brom-Allen
16.5 cm/6 ½"
DC27-115-16



$\frac{2}{3}$
Albrecht
16 cm/6 ¼"
DC27-117-16



$\frac{2}{3}$
Albrecht
16 cm/6 ¼"
DC27-119-16



$\frac{1}{1}$
Miller
15 cm / 6"
DC27-121-16
Practicing Paper
Forcep

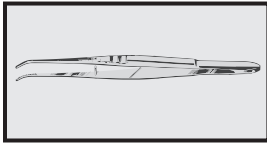

2/3
16cm/6 1/4"
DC27-123-16



2/3
16cm/6 1/4"
DC27-125-16



2/3
12.5cm/5"
DC27-127-12



2/3
13cm/4 3/4"
DC27-129-13



2/3
12cm/4 1/2"
DC27-131-12



2/3
11.5cm/4 1/2"
DC27-133-11



2/3
11.5cm/4 1/2"
DC27-135-16



1/2
17 cm / 6 3/4"
DC27-137-17



1/2
17 cm / 6 3/4"
DC27-139-17



1/2
12 cm / 4 3/4" DC27-141-12
14 cm / 5 1/2" DC27-141-14
16 cm / 6 1/4" DC27-141-16



1/2
13 cm / 5 1/2"
DC27-143-13

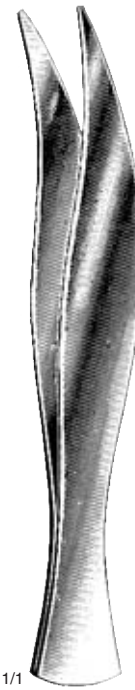

1/1
9 cm / 3 1/2"
DC27-145-09



1/1
9 cm / 3 1/2"
DC27-147-09

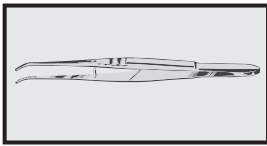

Forceps with Tungsten Carbide Inserts



Adson

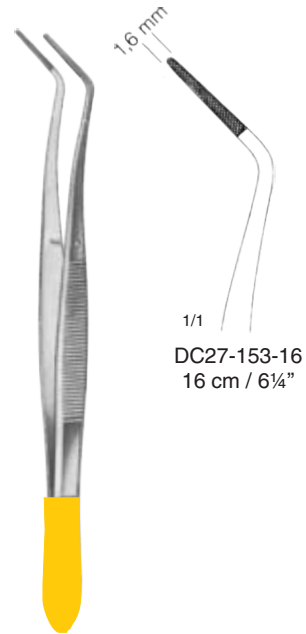
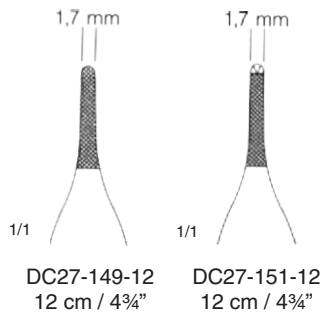

Meriam



Standard

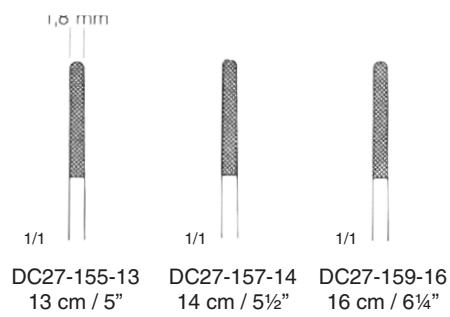

Cushing

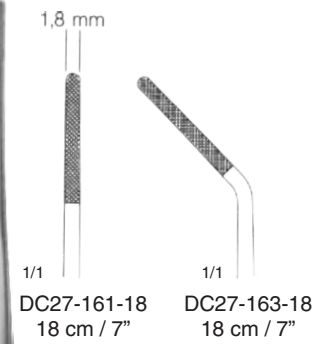

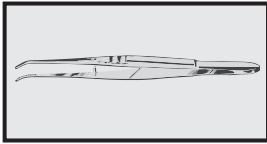

Forceps with Debakey tothing

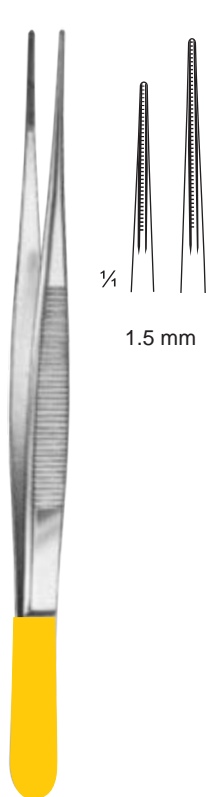

DeBakey
 DC27-165-16 = 16 cm/6 1/4"
 DC27-165-20 = 20 cm/8"

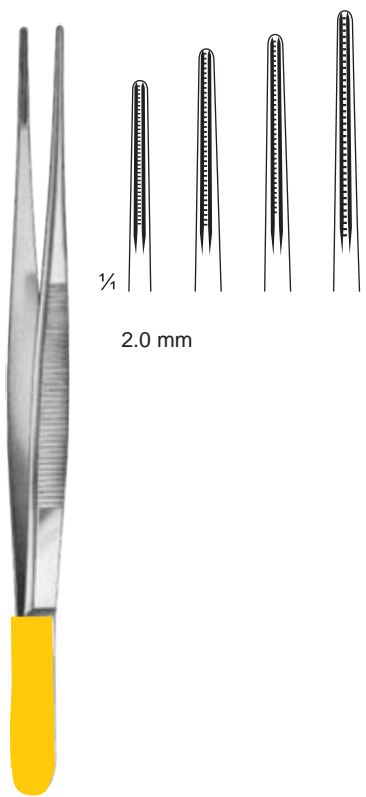

DC27-167-16 = 16 cm/6 1/4"
 DC27-167-20 = 20 cm/8"
 DC27-167-24 = 24 cm/9 1/4"
 DC27-167-30 = 30 cm/12"

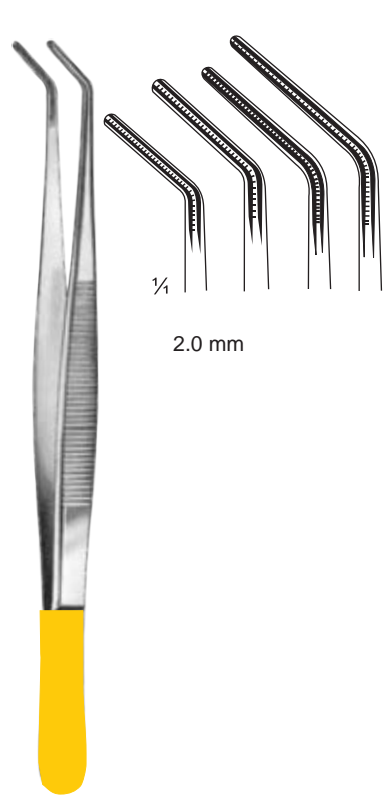

DC27-169-16 = 16 cm/6 1/4"
 DC27-169-20 = 20 cm/8"
 DC27-169-24 = 24 cm/9 1/4"
 DC27-169-30 = 30 cm/12"

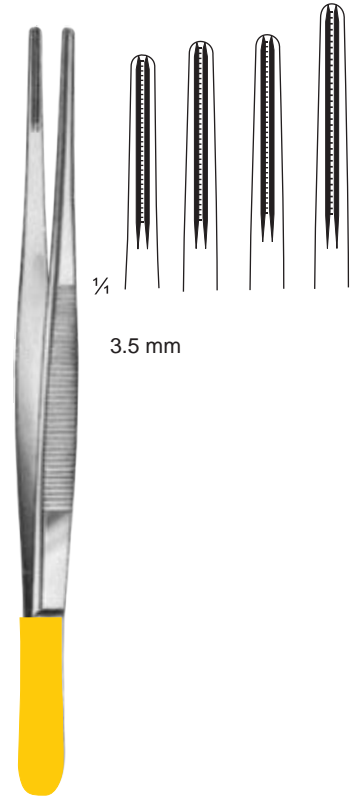

De Bakey
 DC27-171-16 = 16 cm/6 1/4"
 DC27-171-20 = 20 cm/8"
 DC27-171-24 = 24 cm/9 1/4"
 DC27-171-30 = 30 cm/12"

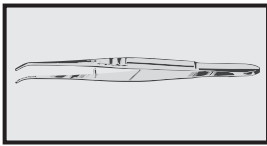

Cotton & Dressing Forceps

Periodontal pocket makers



15cm / 6"
DC27-173-30
(Crane-Kaplan)
Goldman-fox

15cm / 6"
DC27-175-30
(Crane-Kaplan)
Goldman-fox



16cm / 6½"
DC27-177-30
Fig-18L
Locking



15cm / 6"
DC27-179-30
Fig-1
Self Locking



15cm / 6"
DC27-181-30
Fig-2
Self Locking



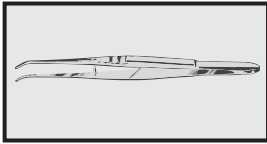

Splinter Forceps & Soldering Devices



14 cm/5 1/2"
DC27-193-30
self-retaining,
round ends



14 cm/5 1/2"
DC27-195-30
self retaining,
flat ends



	cm	inches
DC27-197-30	12	4 3/4
DC27-197-14	14	5 1/2
DC27-197-16	16	6 1/4



DC27-199-12
DC27-199-14
DC27-199-16



13 cm/5 1/8"
DC27-201-13



13 cm/5 1/8"
DC27-203-13
DC27-205-00

DC27-205-00
pair



16 cm/6 1/4"
DC27-207-19
DC27-209-00



16 cm/6 1/4"
DC27-211-16
DC27-213-00

DC27-213-00
pair



16 cm/6 1/4"
DC27-215-16 - DC27-221-02



DC27-215-16
Spare tips, in pairs



DC27-217-16

DC27-219-02 DC27-221-02

insulated handle

4

FÓRCEPS HEMOSTÁTICOS



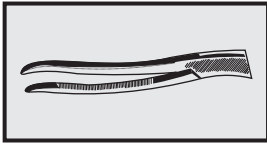

		Pean	
		Straight	Curved
cm	in		
13	5	DC28-001-13	DC28-003-13
14	5½	DC28-001-14	DC28-003-14
16	6¼	DC28-001-16	DC28-003-16

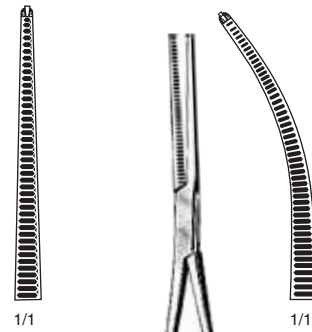

		Straight	Curved
cm	in		
13	5	DC28-005-13	DC28-007-13
14	5½	DC28-005-14	DC28-007-14
16	6¼	DC28-005-16	DC28-007-16



Kocher

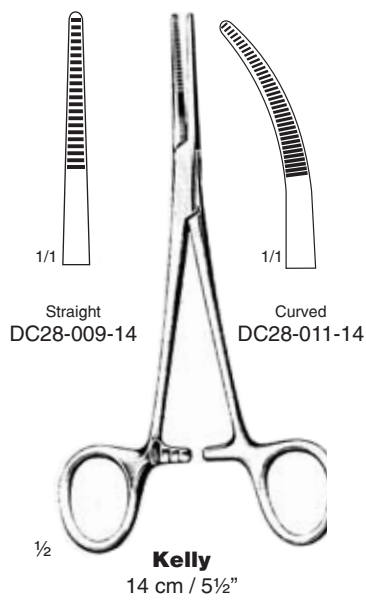

		Straight	Curved
cm	in		
14	5½	DC28-009-14	DC28-011-14

Kelly
14 cm / 5½"

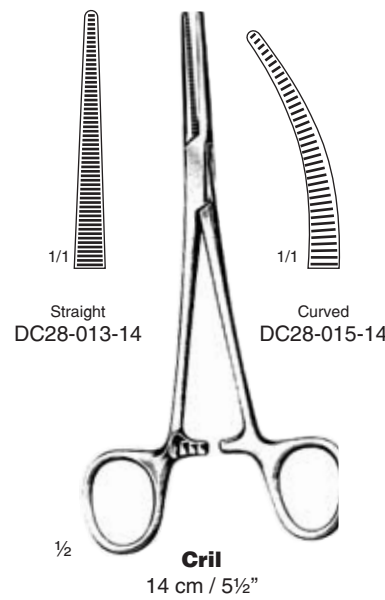

		Straight	Curved
cm	in		
14	5½	DC28-013-14	DC28-015-14

Cril
14 cm / 5½"

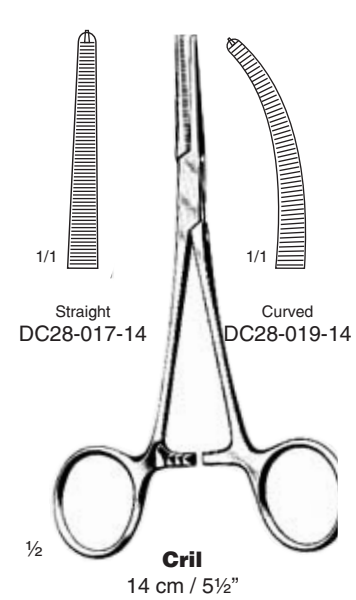

		Straight	Curved
cm	in		
14	5½	DC28-017-14	DC28-019-14

Cril
14 cm / 5½"

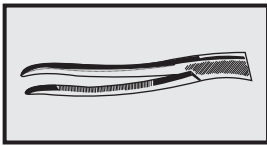

Hemostatic Forceps

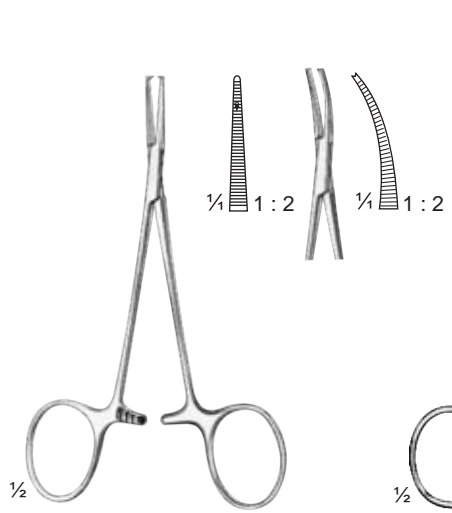

Halstead-Mosquito (Micro)

cm	in	Straight	Curved
12.5	5	DC28-021-12	DC28-023-12

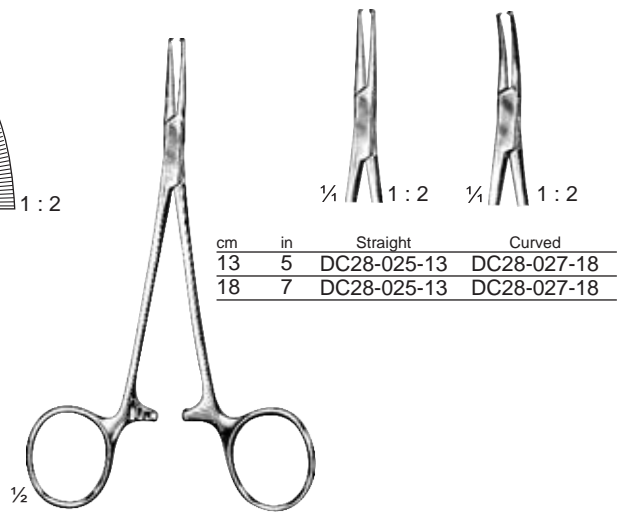

cm	in	Straight	Curved
13	5	DC28-025-13	DC28-027-18
18	7	DC28-025-13	DC28-027-18

Halstead-Mosquito

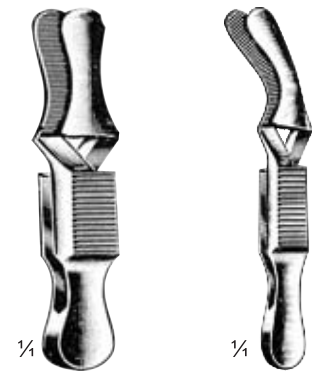

Dieffenbach
 3.5 cm / 1 1/2"
 DC28-029-03
 5 cm / 2"
 DC28-029-05

Dieffenbach
 3.5 cm / 1 1/2"
 DC28-031-04
 5 cm / 2"
 DC28-031-05

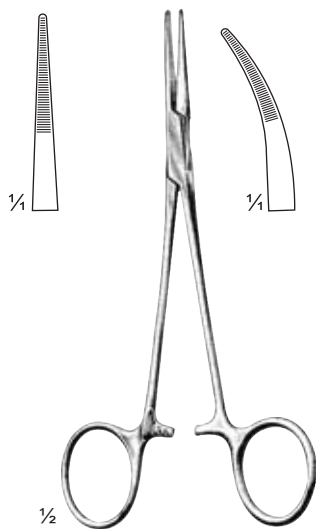

Providence-Hospital

cm	in	Straight	Curved
14	5 1/2	DC28-033-14	DC28-035-14

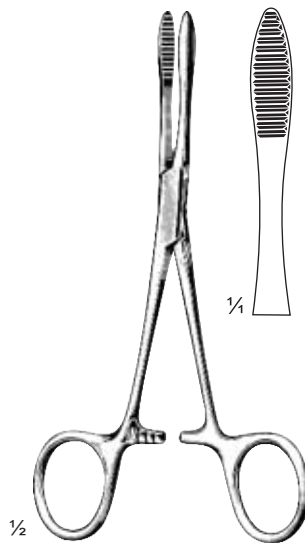

Pean

cm	in	Straight	Curved
14	5 1/2	DC28-037-14	
16	6 1/4	DC28-037-16	

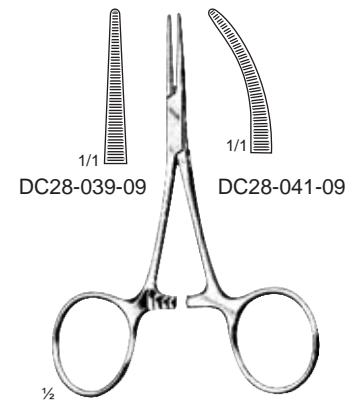

Hartmann
 10 cm / 4"

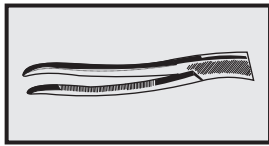

Hemostatic & Towel Forceps

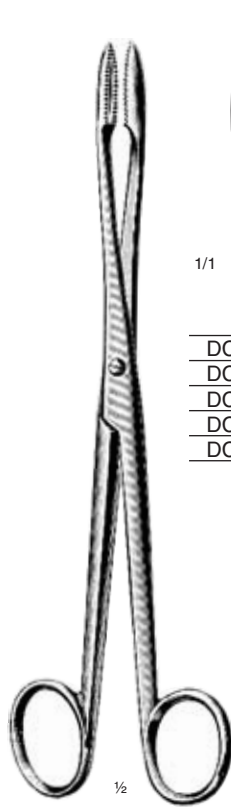

Gross-Maier

		cm	in		
DC28-043-14	DC28-045-14	14.5	5 1/2	DC28-047-14	DC28-049-14
DC28-043-16	DC28-045-16	16	6 1/4	DC28-047-16	DC28-049-16
DC28-043-18	DC28-045-18	18	7	DC28-047-18	DC28-049-18
DC28-043-20	DC28-045-20	20	8	DC28-047-20	DC28-049-20
DC28-043-25	DC28-045-25	25	10	DC28-047-25	DC28-049-25

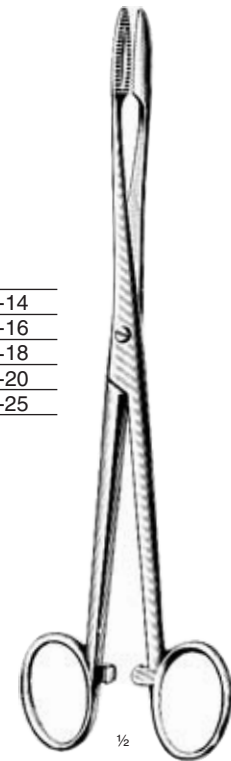

Gross-Maier

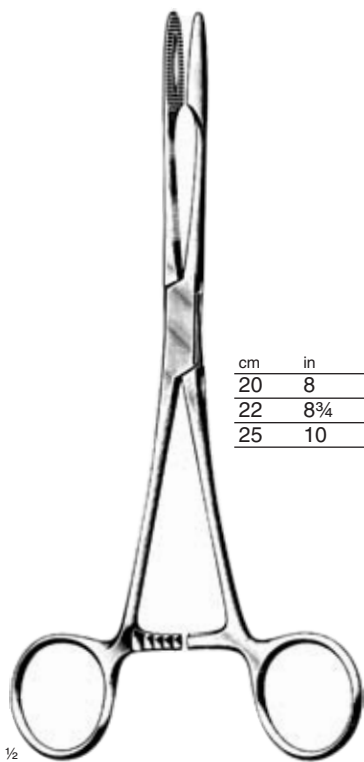

Gross-Maier

cm	in		
20	8	DC28-051-20	DC28-053-20
22	8 3/4	DC28-051-22	DC28-053-22
25	10	DC28-051-25	DC28-053-25

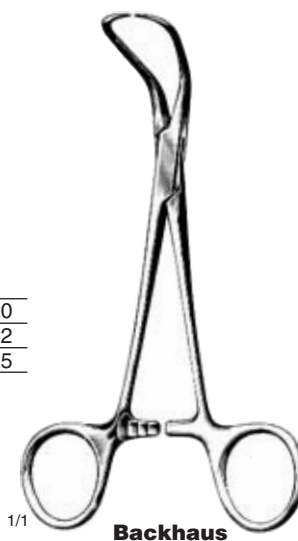

Backhaus

cm	in	
8	3 1/4	DC28-055-08
11	4 1/2	DC28-055-11
13	5	DC28-055-13
15	6	DC28-055-15



SchZBdel
9 cm / 3 1/2"
DC28-057-09



Jones
5 cm / 2"
DC28-059-05
9 cm / 3 1/2"
DC28-059-09

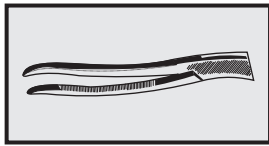

Seizing Forceps & Crucible Tongs

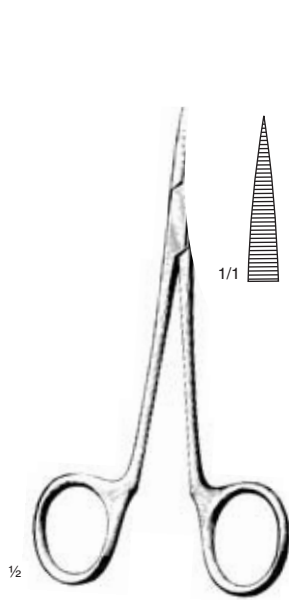

Physician
13 cm / 5"
DC28-061-13



Allis
15 cm / 6"

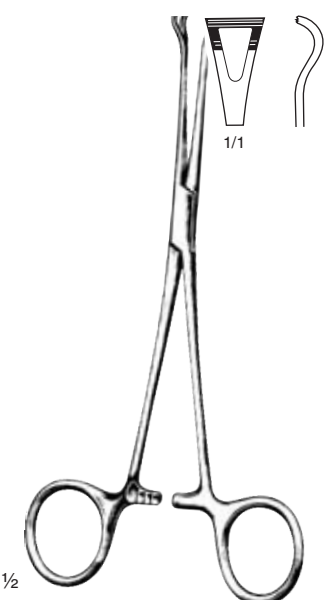

Babcock
16 cm / 6 1/4"
DC28-067-16

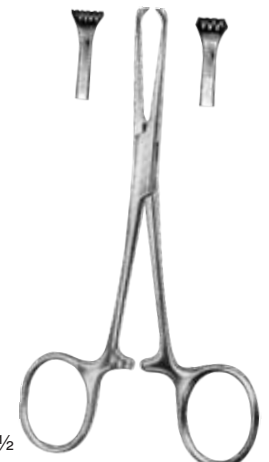

Allis-Baby
14.5 cm / 5 3/4"
DC28-069-14



Cheatle
27 cm / 10 1/2"
DC28-071-27

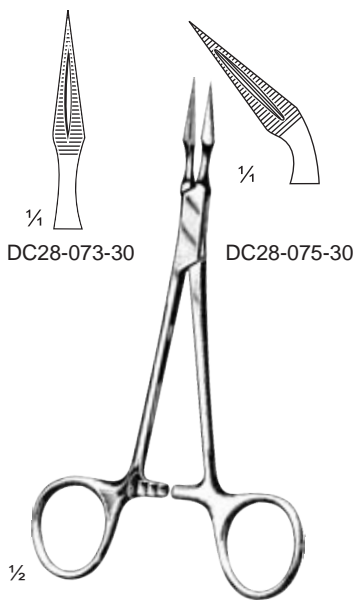

Stieglitz
13.5 cm / 5 1/2"



Peet
11.5 cm / 4 1/2"
DC28-077-30

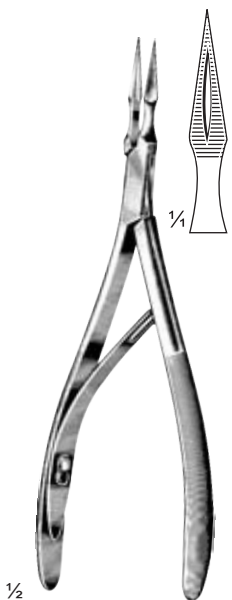

Ralk
15 cm / 6"
DC28-079-30



Ralk
15 cm / 6"
DC28-081-30

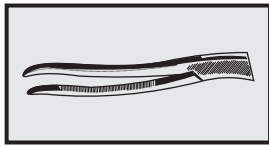

Universal Seizing Forceps, Waste Forceps

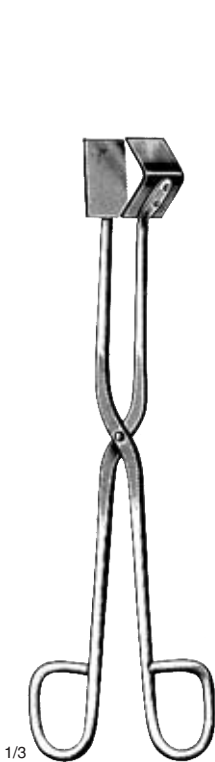

1/3
24 cm / 9½"
DC28-083-24

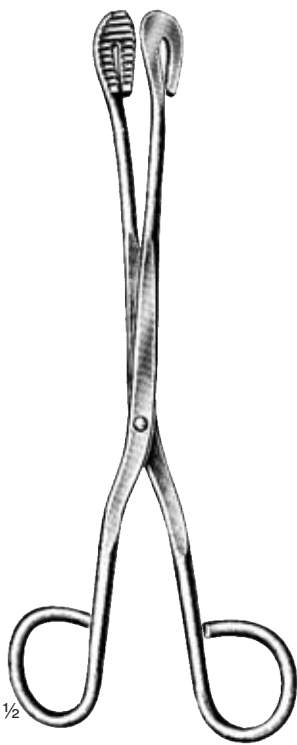

1/2
Universal
20 cm / 8" DC28-085-20
28 cm / 11" DC28-085-28

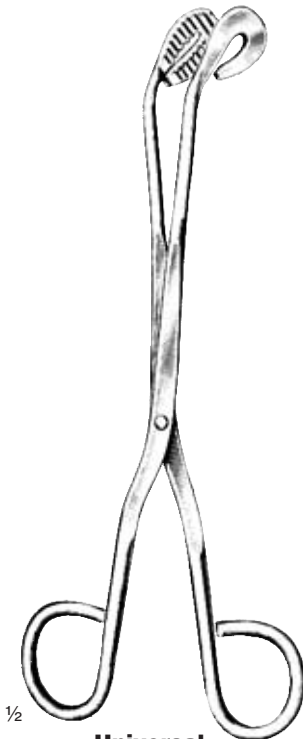

1/2
Universal
20 cm / 8" DC28-087-20
28 cm / 11" DC28-087-28



1/6
58 cm / 22¾"
DC28-089-58



1/6
Sauerbruch
55 cm / 21½"
DC28-091-55



1/3
22 cm / 8" DC28-093-22
32 cm / 12½" DC28-093-32
50 cm / 20" DC28-093-50



1/3
22 cm / 8" DC28-095-22
25 cm / 10" DC28-095-25
32 cm / 12½" DC28-095-32
50 cm / 20" DC28-095-50

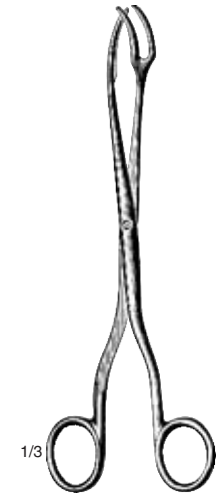

1/3
20 cm / 8" DC28-097-20
30 cm / 12" DC28-097-30

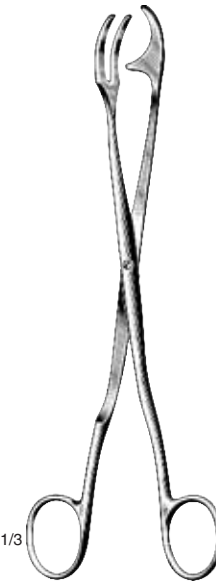

1/3
Rogge
23 cm / 9"
DC28-099-23



1/3
24.5 cm / 9¾"
DC28-101-24

5

ELEVADORES DE RAIZ



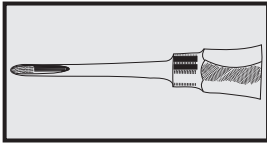

Root Elevators

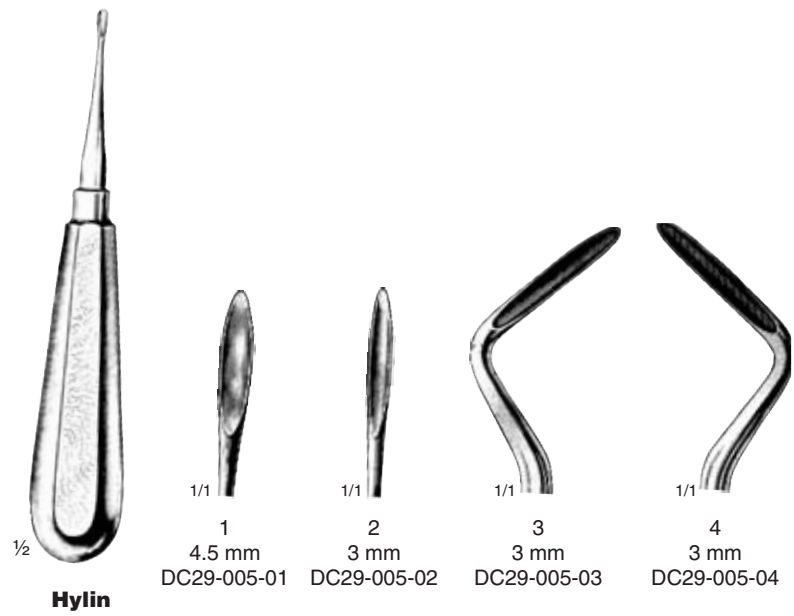
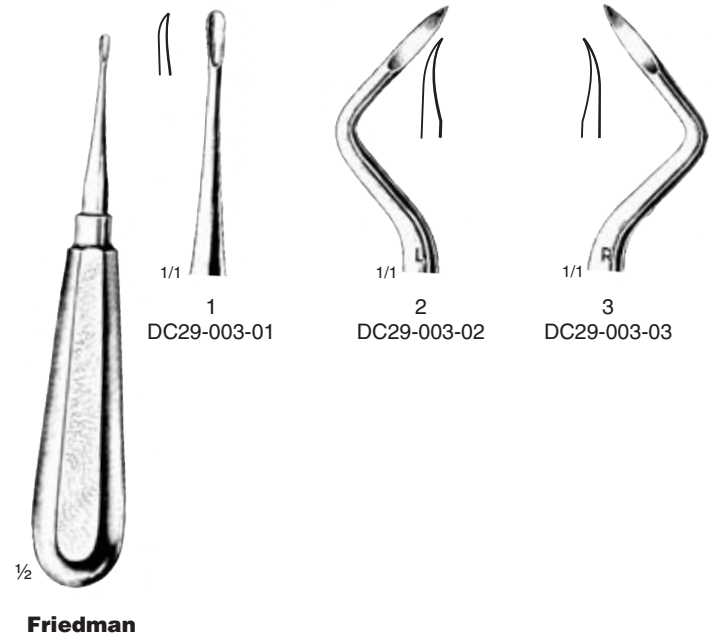
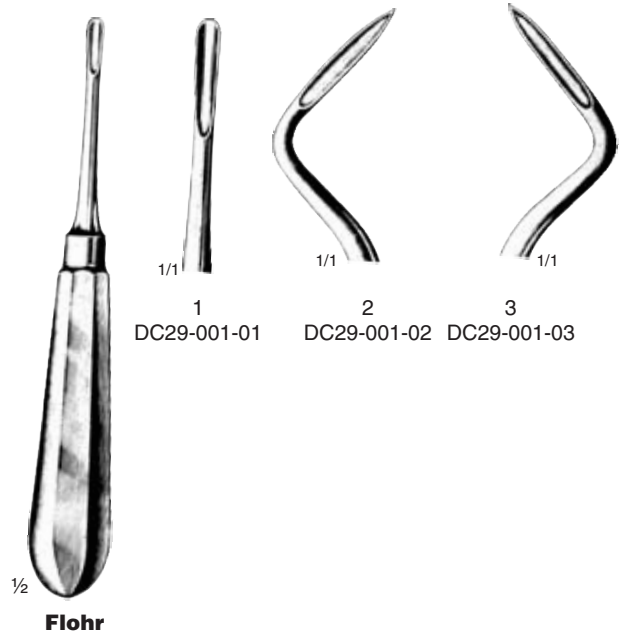

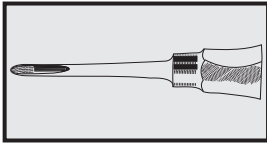

Root Elevators

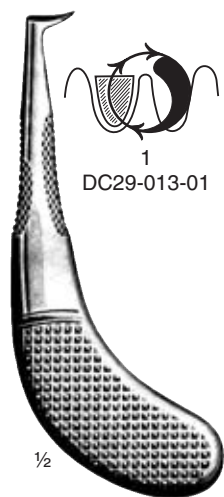
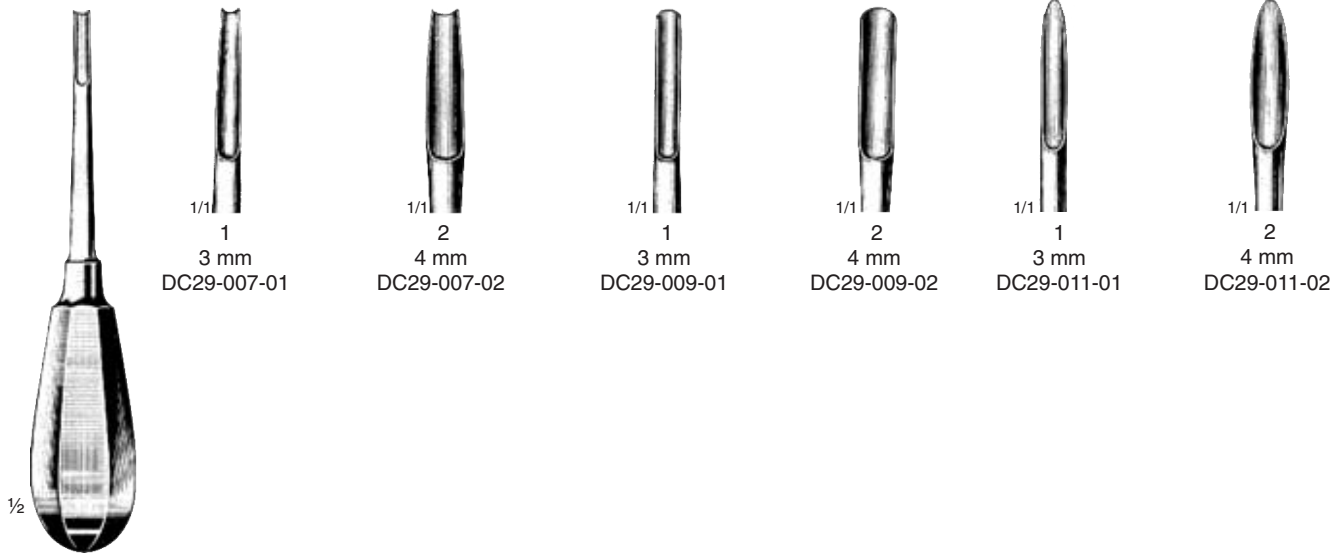

Krallenheber
DC29-013-00

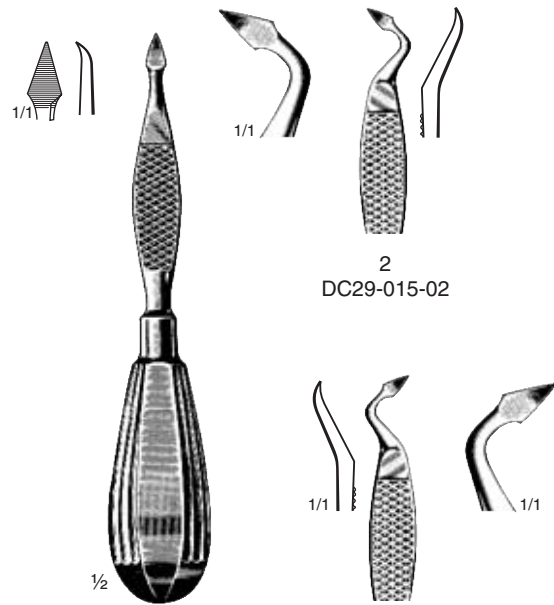

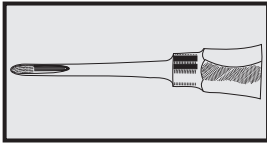

Root Elevators



1/2

Loos

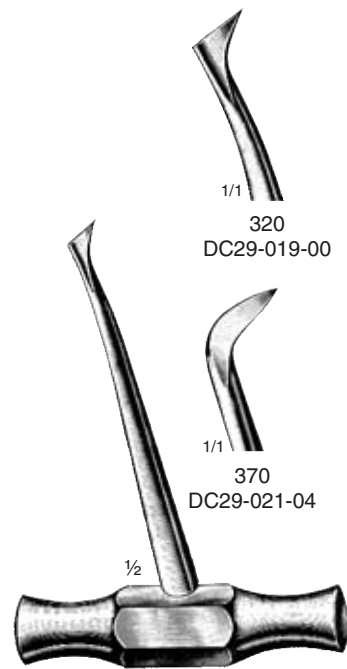

Walter F. Barry

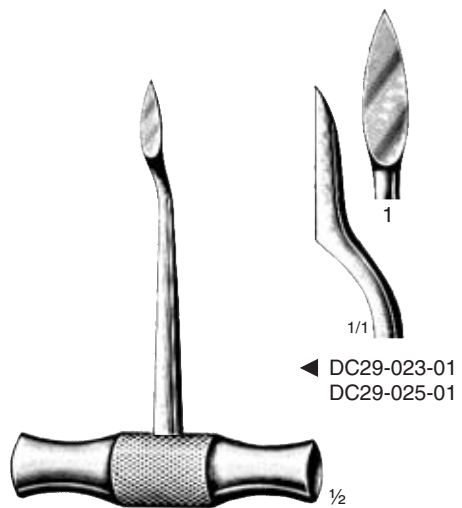
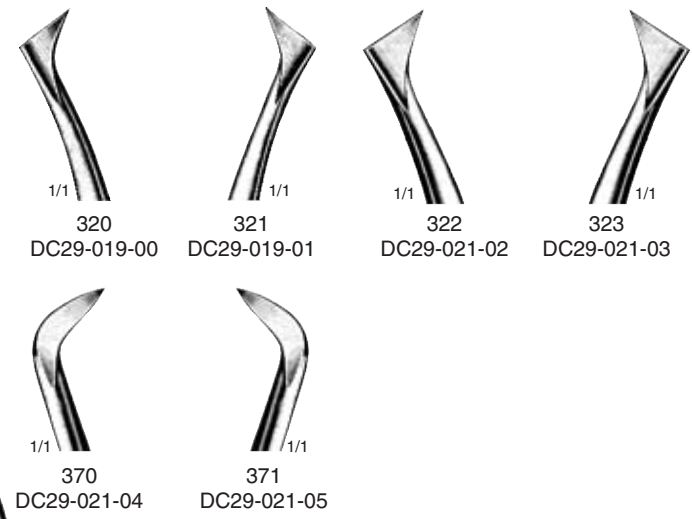

Lecluse

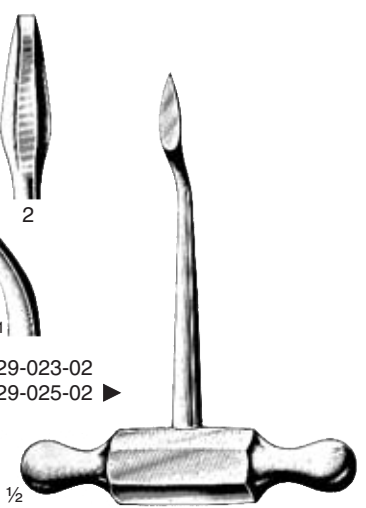
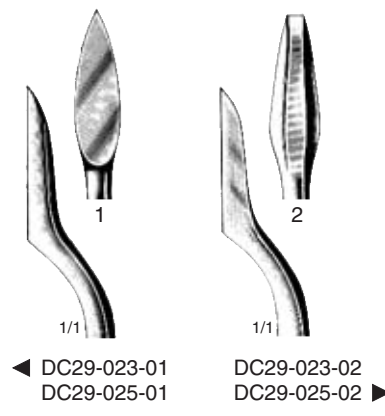

Lecluse

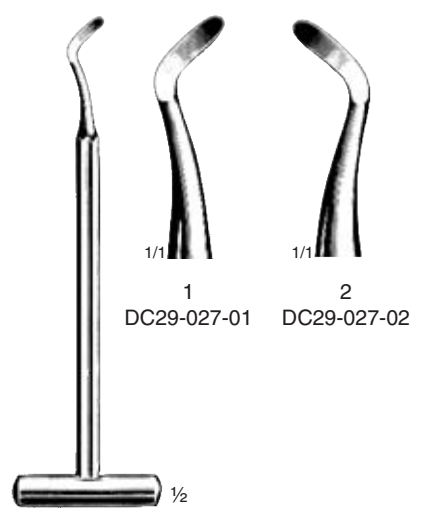

Pott

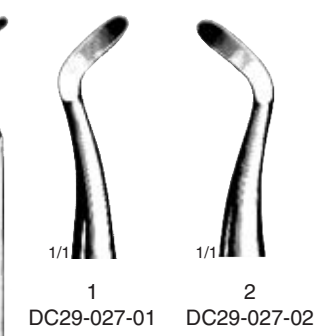

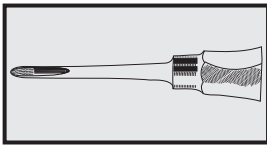

Root Elevators

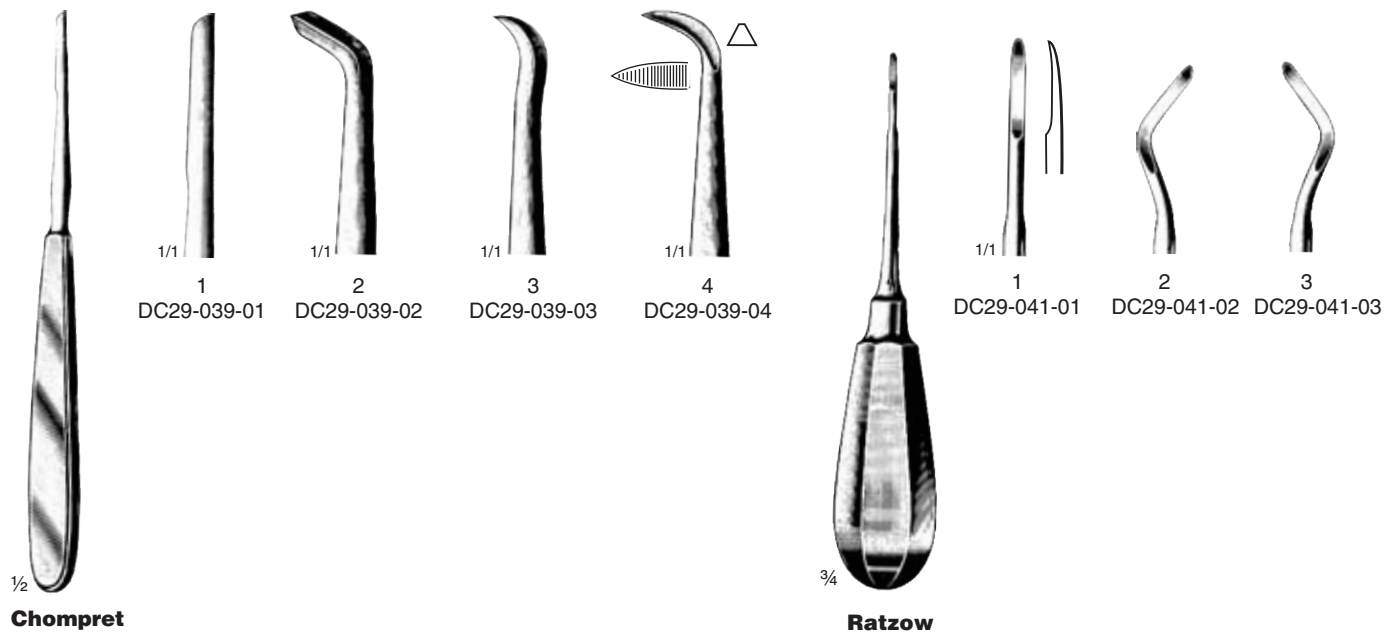
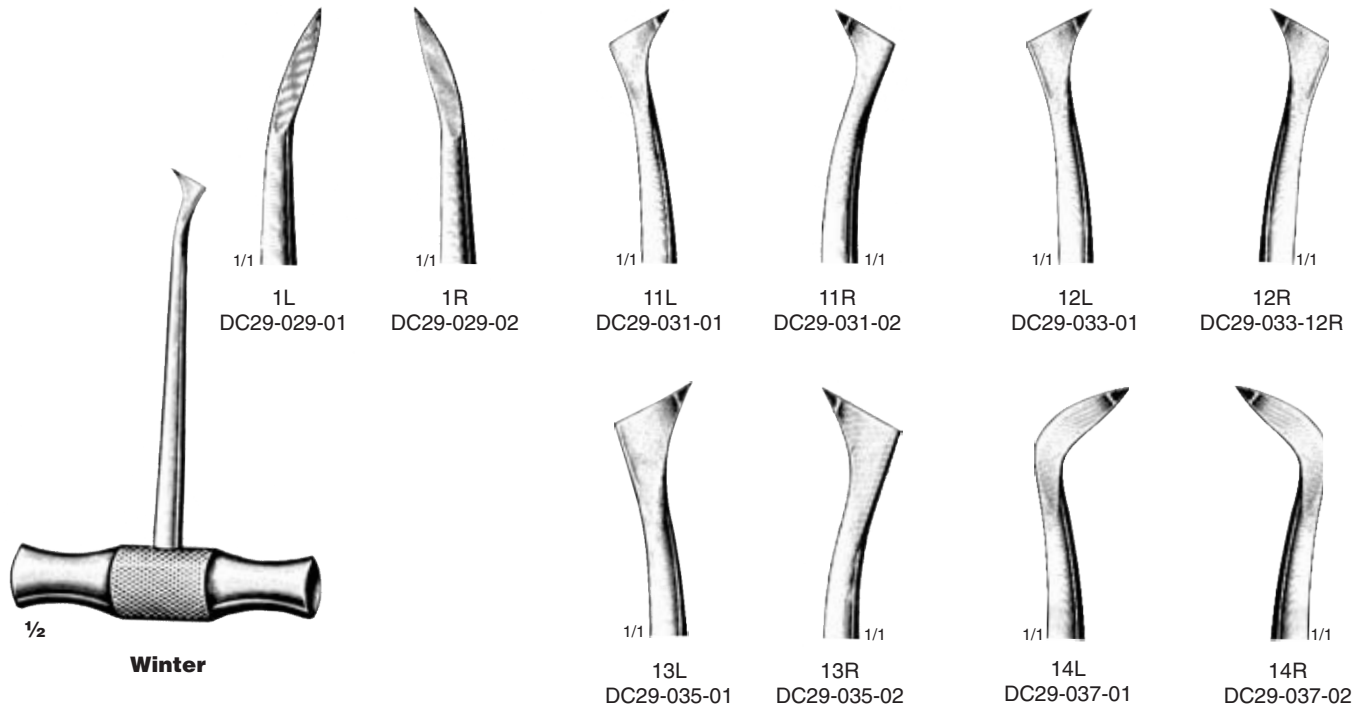

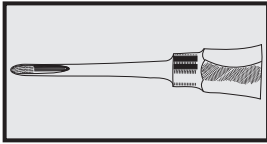

Heidebrink
DC29-043-01

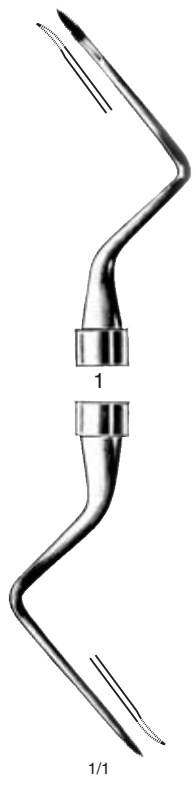

Heidebrink
DC29-043-01

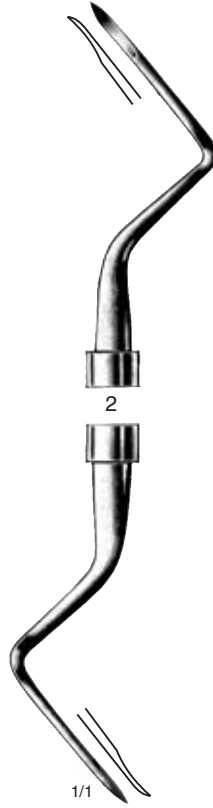

Heidebrink
DC29-045-02

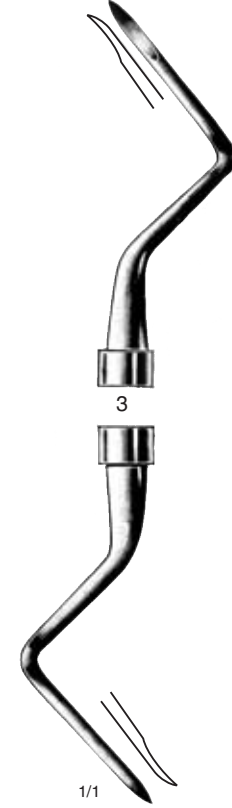

Heidebrink
DC29-047-03



Heidebrink
DC29-049-00

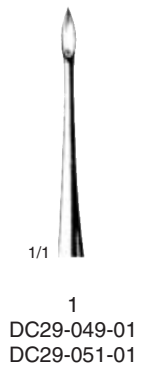

Heidebrink
DC29-049-01
DC29-051-01

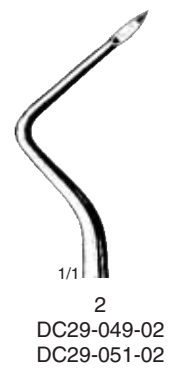

Heidebrink
DC29-049-02
DC29-051-02



Heidebrink
DC29-049-03
DC29-051-03



Heidebrink
DC29-051-00

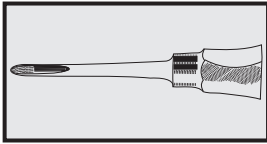

Root Elevators

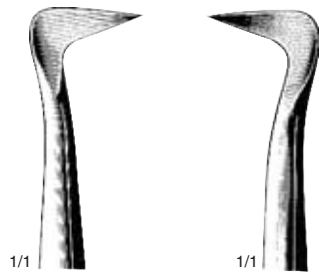

1/1
1L
Seldin
DC29-053-01

1/1
1R
Seldin
DC29-053-02

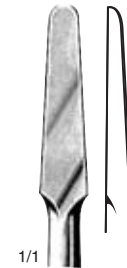

1/1
2
Seldin
DC29-055-02



1/1
3
Seldin
DC29-055-03

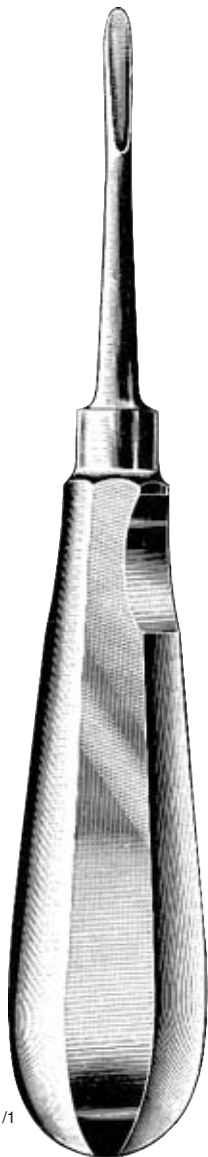

1/1



1/1
3A
Cryer
DC29-057-31



1/1
4L
Seldin
DC29-059-04



1/1
4R
Seldin
DC29-059-05



1/1
6
Crane Pick
DC29-061-06



1/1
8
Miller
DC29-063-08



1/1
9
Miller
DC29-063-09



1/1
10
Miller
DC29-065-10



1/1
11
Miller
DC29-065-11



1/1
12
Cryer
DC29-067-12

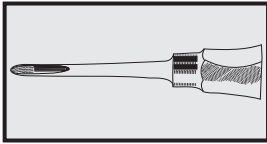

Root Elevators



1/1



1/1

27

Cryer

DC29-069-27



1/1

28

Cryer

DC29-071-28



1/1

34

Seldin

DC29-073-34



1/1

34S

Seldin

DC29-075-34

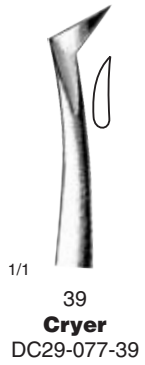

1/1

39

Cryer

DC29-077-39



1/1

40

Cryer

DC29-079-40



1/1

46

DC29-081-46

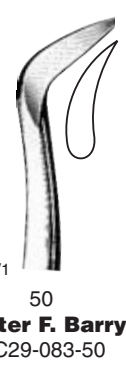

1/1

50

Walter F. Barry

DC29-083-50



1/1

51

Walter F. Barry

DC29-085-51



1/1

301

Apical

DC29-087-01



1/1

302

Apical

DC29-089-02



1/1

303

Apical

DC29-091-03



1/1

304

Apical

DC29-093-04

6

FÓRCEPS DE EXTRACCIÓN



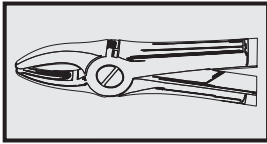

Extracting Forceps

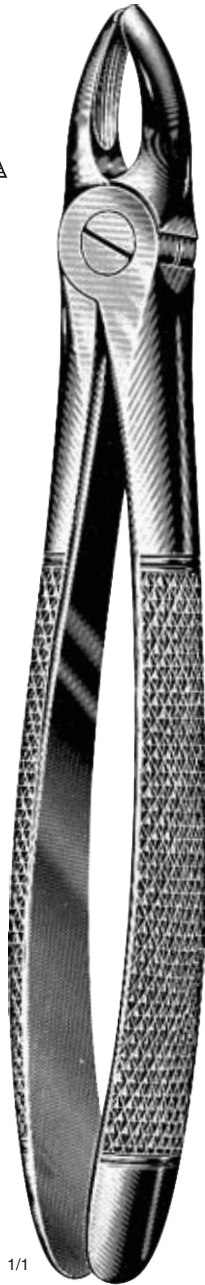

1
DC30-001-01
For Upper Centrals and Canines

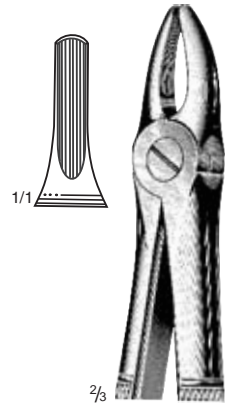

2
DC30-003-02
For Upper Laterals and Bicuspids

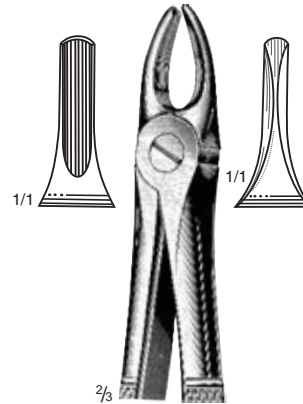

3
DC30-005-03
For Upper Incisors and Canines
Crowned Internally & Externally

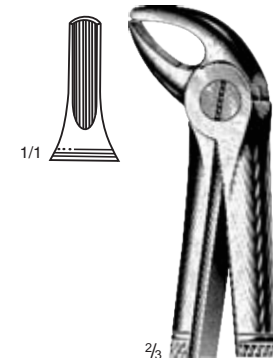

4
DC30-007-04
For Lower Incisors and Canines

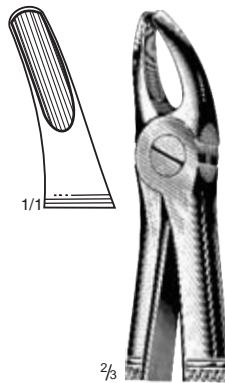

7
DC30-009-07
For Upper Bicuspids, either side

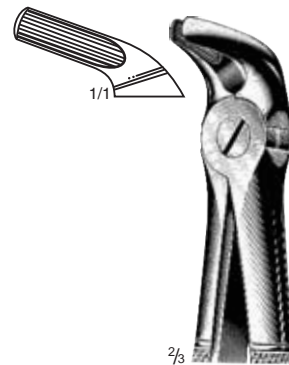

8
DC30-011-08
For Lower Bicuspids, either side

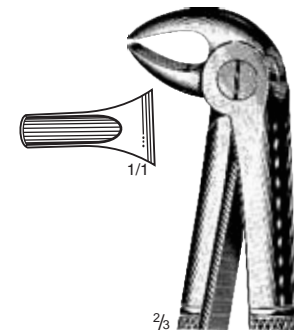

13
DC30-013-13
For Lower Bicuspids, either side

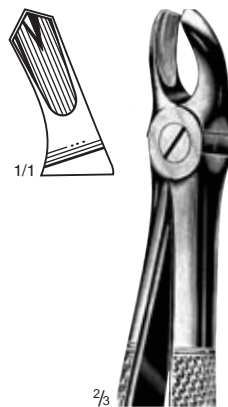

17
DC30-015-17
For Right Upper Molars

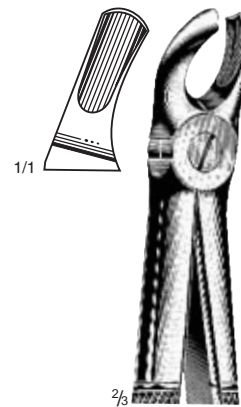

18
DC30-017-18
For Left Upper Molars

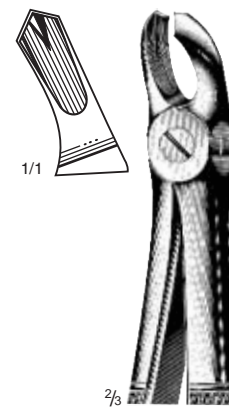

18A
DC30-019-18
For Upper Molars-either side

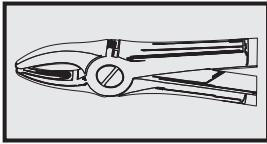

Extracting Forceps

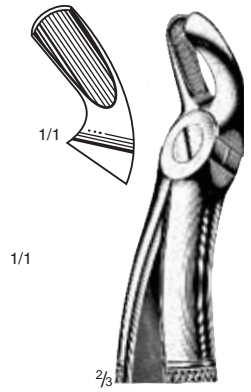

19
DC30-021-19
For Upper Wisdoms-either side

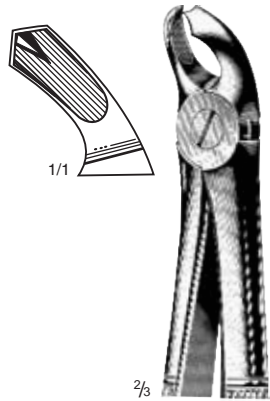

20
DC30-023-20
For Lower Wisdoms-either side

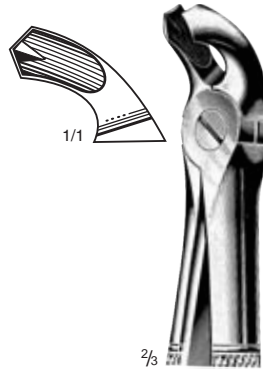

21
DC30-025-21
For Lower Molars-either side

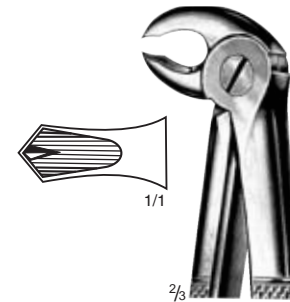

22
DC30-027-22
For Lower Molars-either side

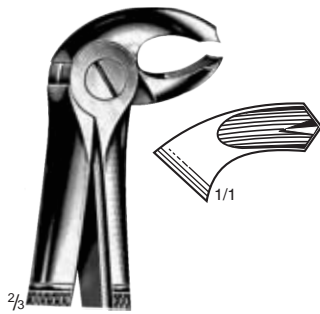

23
DC30-029-23
For Right Lower Molars

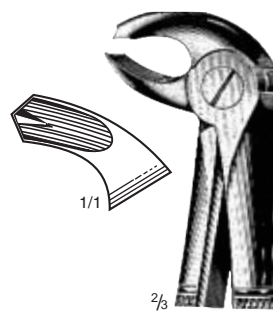

24
DC30-031-24
For Left Lower Molars

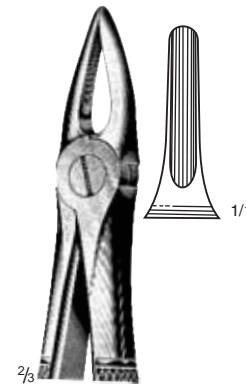

29
DC30-033-29
For Upper Roots and Incisors-either side

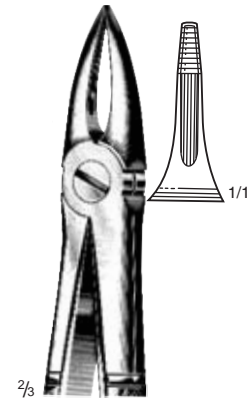

29N
DC30-035-29
For Roots of Upper Incisors

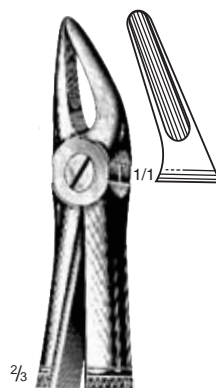

30
DC30-037-30
For Upper Roots and Incisors-either side

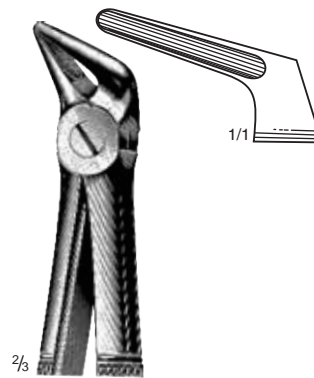

31
DC30-039-31
For Lower Roots-either side

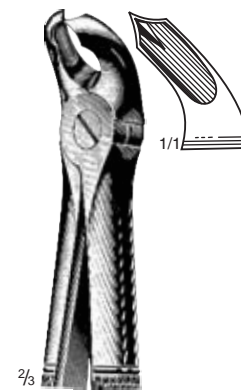

32
DC30-041-32

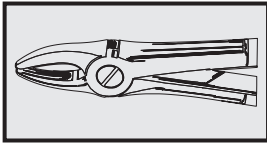

Extracting Forceps

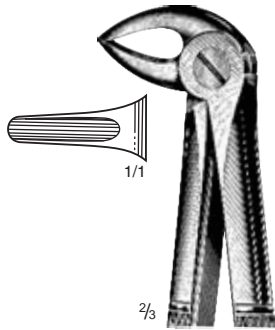

33
DC30-043-33

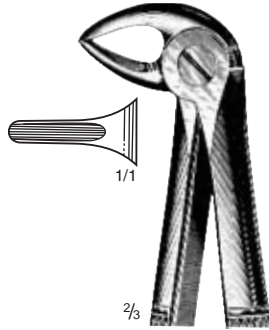

33A
DC30-045-33

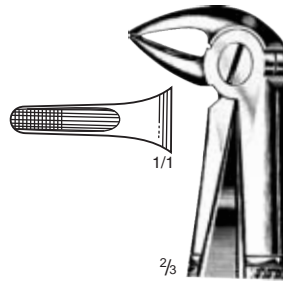

33C
DC30-047-33

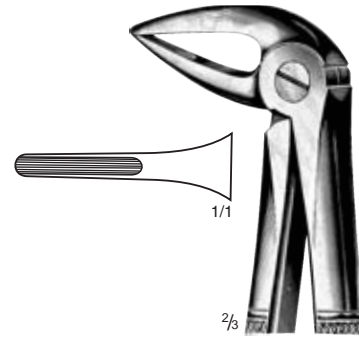

33M
DC30-049-33

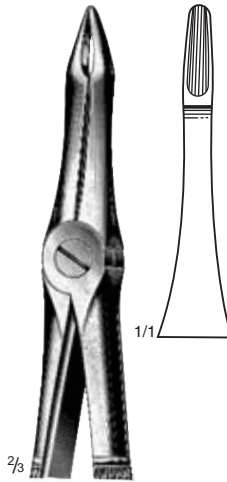

41
DC30-051-41

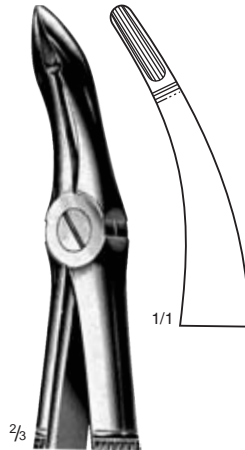

44
DC30-053-44

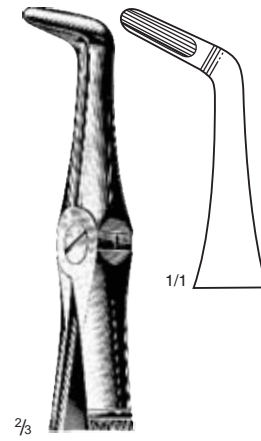

45
DC30-059-45

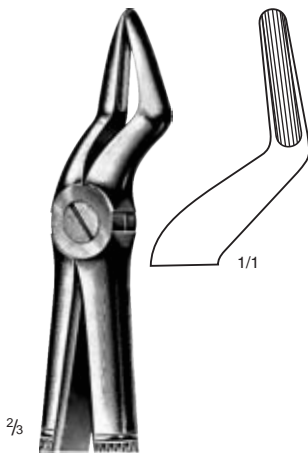

51
DC30-055-51

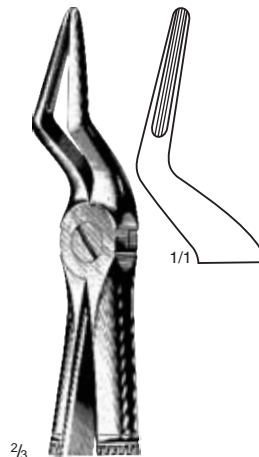

51A
DC30-061-51

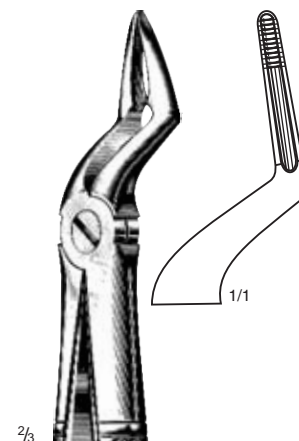

51C
DC30-057-51

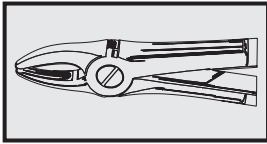

Extracting Forceps

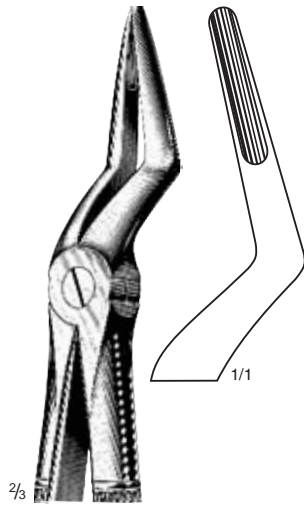

51M
DC30-063-51
For Deep Upper Roots

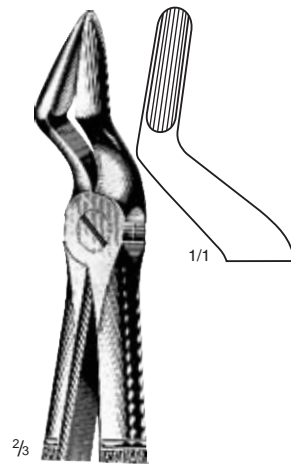

52
DC30-069-52
For Upper Roots and Canines

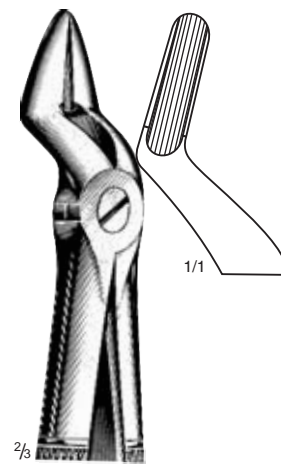

52A
DC30-065-52
For Upper Teeth and Resection-either side

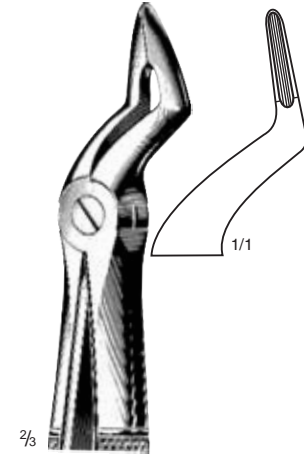

53 Witzel
DC30-071-53
For Upper Roots

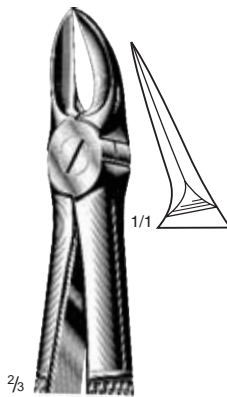

55
DC30-067-55
For Separating Upper Molar Roots

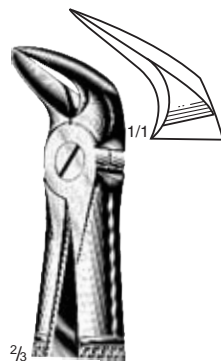

56
DC30-073-56
For Separating Lower Molar Roots

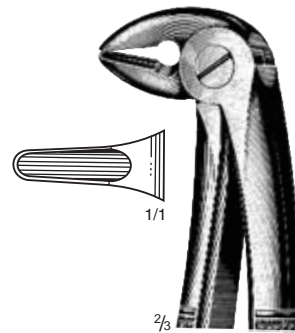

59
Busch
DC30-075-59
Resection Forceps for Lower Roots

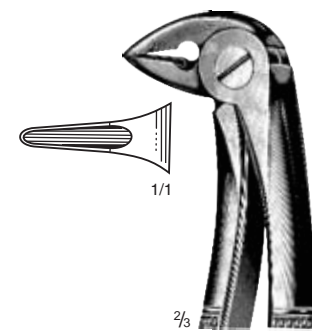

60
Busch
DC30-077-60
Resection Forceps for Lower Roots

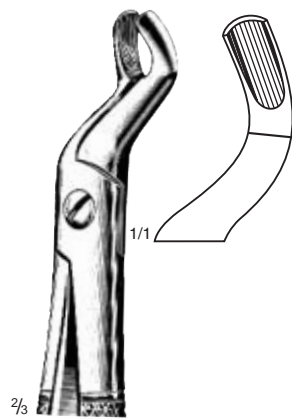

67
DC30-079-67
For Upper Wisdoms, either side

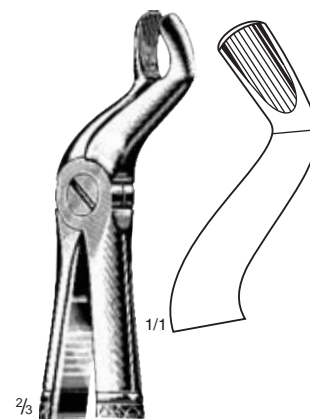

67A
DC30-081-67
For Upper Wisdoms, either side

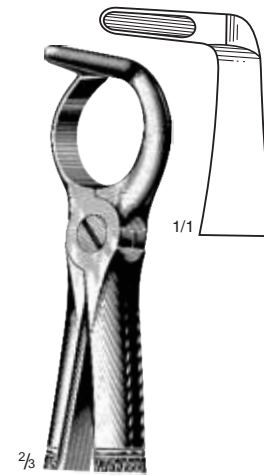

68
DC30-083-68
For Lower Roots, either side

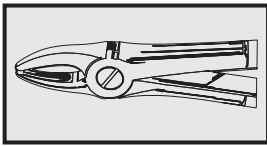

Extracting Forceps



73
DC30-085-73



74
DC30-087-74



74M
DC30-089-74



74N
DC30-091-74



75
DC30-093-75

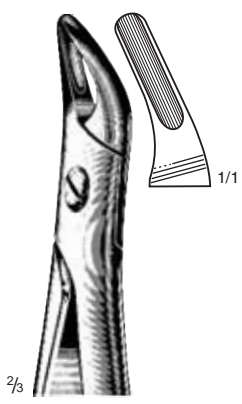

76
Lawrence read
DC30-095-76

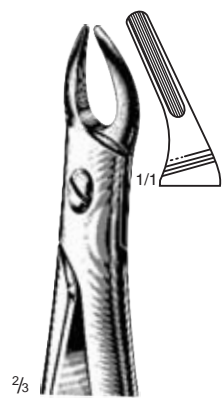

76N
Lawrence read
DC30-097-76

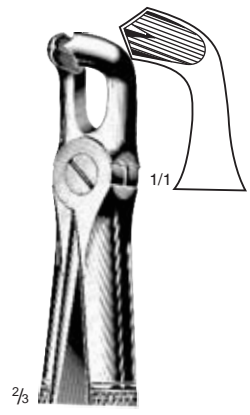

79
DC30-099-79

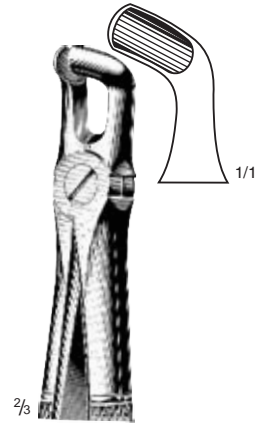

79A
DC30-103-79
For Lower Wisdoms
either side



86A
DC30-105-86
For Lower Molar with decayed or
broken-down crown, either side



86B
DC30-107-86
For Lower Molar with decayed or
broken-down crown, either side



86C
DC30-109-86
For Lower Molar with decayed or
broken-down crown, either side

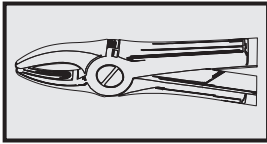

Extracting Forceps

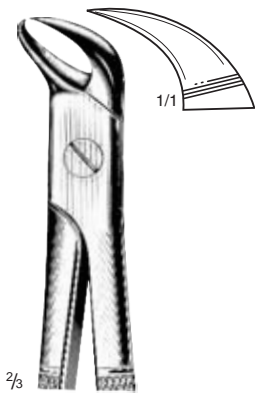

87
DC30-111-87
For Lower Molar with decayed or broken-down crown, either side

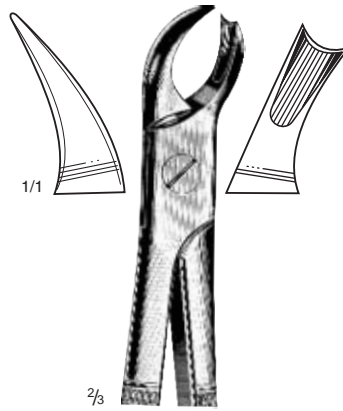

89
DC30-113-89
For Right Upper Molar

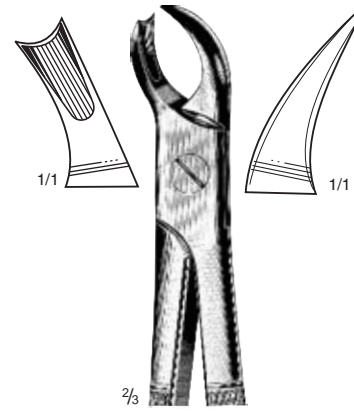

90
DC30-115-90
For Left Upper Molar

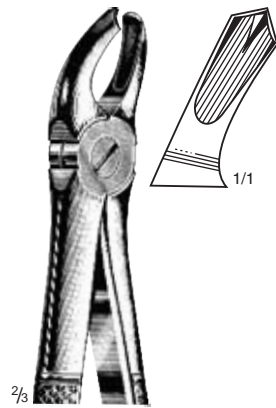

94
DC30-117-94
For Right Upper Molar

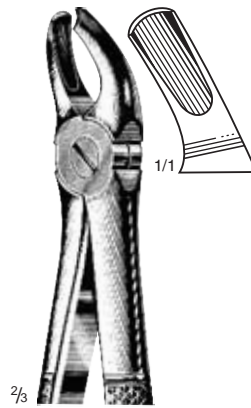

95
DC30-119-95
For Left Upper Molar



99
Wood
DC30-121-99
For Broken-Down Lower Molar either side



99 1/4
Passow
DC30-123-99
For Broken-Down Lower Molar either side

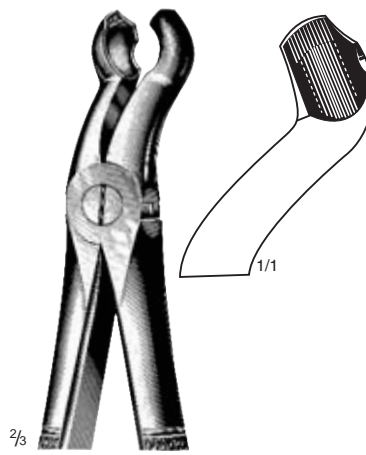

121
Ogden-Felsch
DC30-125-21
For Upper Wisdoms

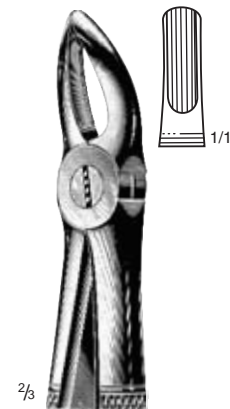

136
Guy
DC30-127-36
For Upper Centrals and Roots

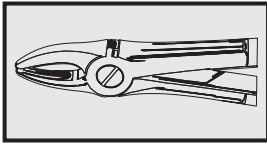

Extracting Forceps



137
Guy
DC30-129-37
For Lower Centrals and Roots

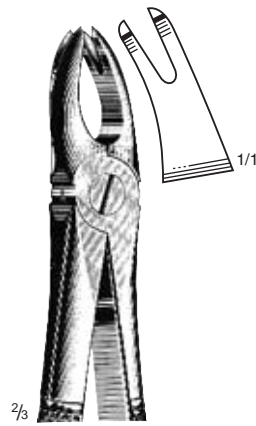

166
Trotter
DC30-131-66
For Upper Teeth, Bicuspids



167
Trotter
DC30-133-67
For Lower Teeth, Bicuspids

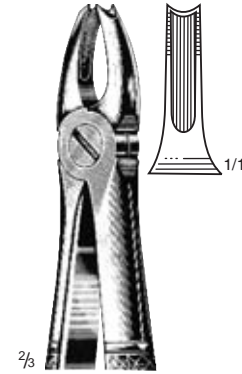

168
Trotter
DC30-135-68
For Upper Canines

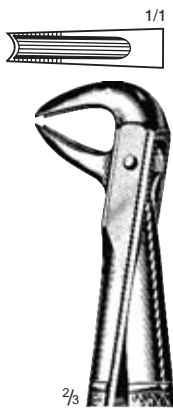

169
Trotter
DC30-137-69
For Lower Canines and, Bicuspids

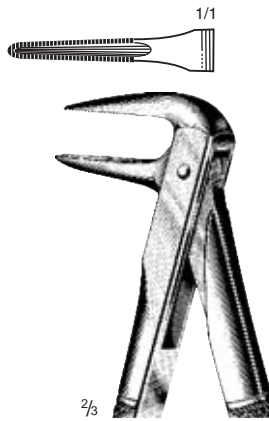

233
DC30-139-33
For Lower Roots

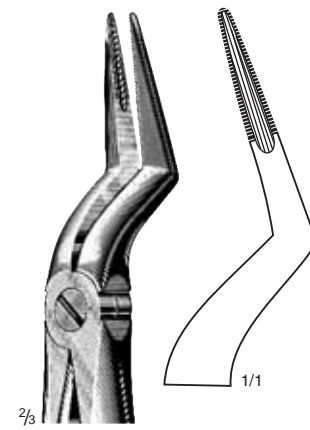

235
DC30-141-35
For Upper Roots

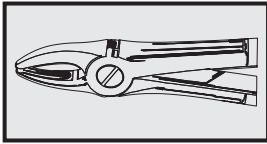

Extracting Forceps



1
DC30-149-01
For Upper Central and Canines

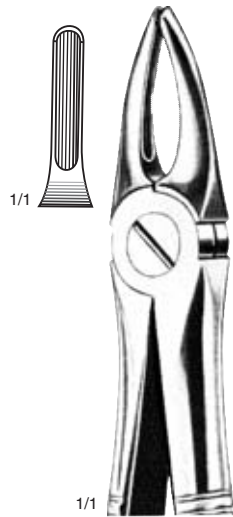

2
DC30-143-02
For Upper Laterals
and Bicuspsids

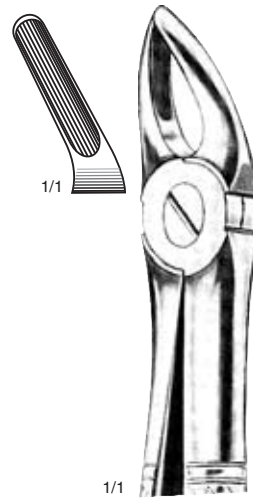

7
DC30-145-07
For Upper Bicuspid
either side

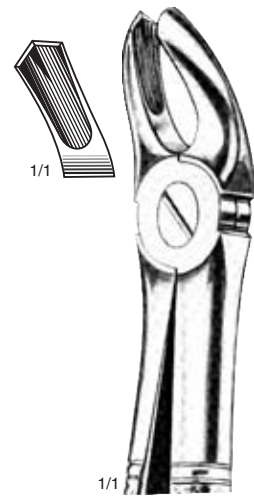

17
DC30-147-17
For Right Upper Molars

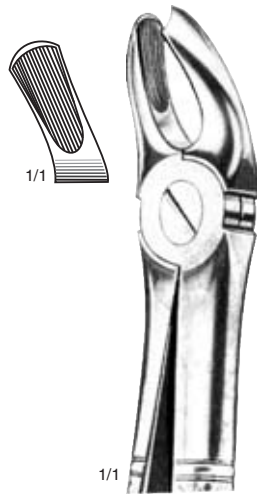

18
DC30-151-18
For Left Upper Molars

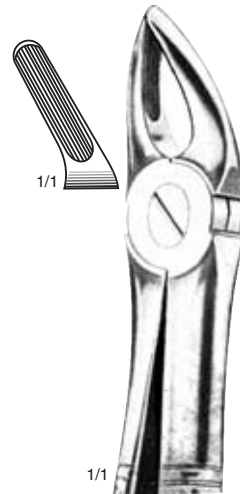

30
DC30-153-30
For Upper Incisors and Roots
either side

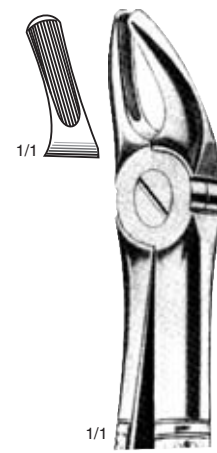

39
DC30-155-39
For Upper Molars
either side

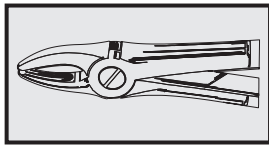

Extracting Forceps

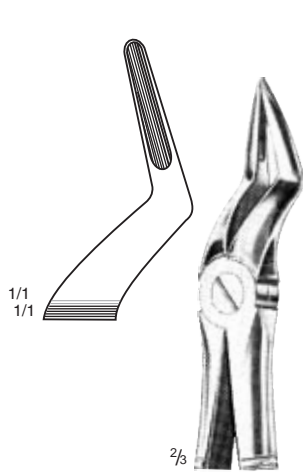

51
DC30-157-51
For Upper Roots

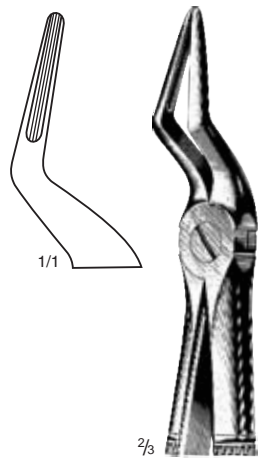

51A
DC30-159-51
For Upper Roots

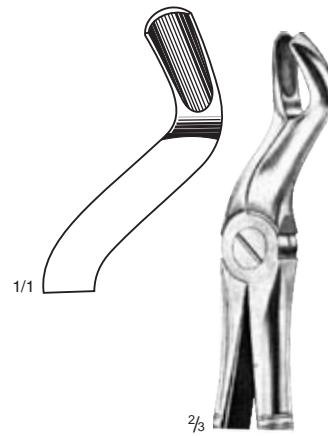

67A
DC30-161-67
For Upper Wisdoms, either side

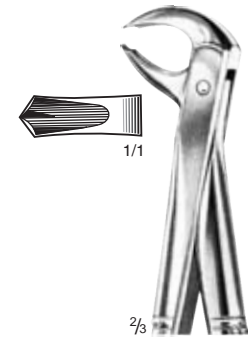

73
DC30-163-73
For Lower Molars-either side

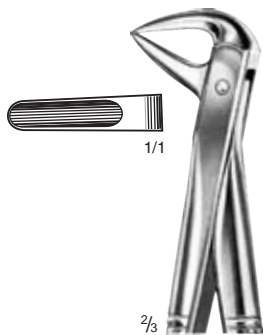

74
DC30-165-74
For Lower Incisors and Roots-either side

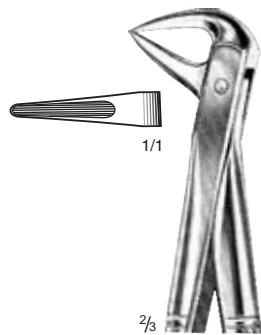

74N
DC30-167-74
For Lower Incisors and Roots

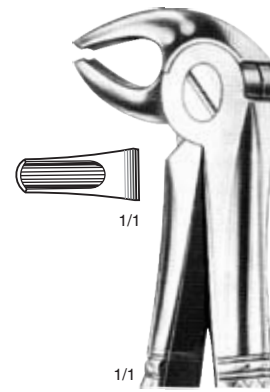

13
DC30-169-13
For Lower Bicuspids-either side

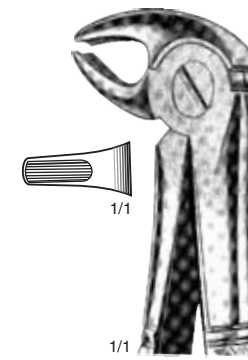

13S
DC30-171-13
For Lower Bicuspids-either side

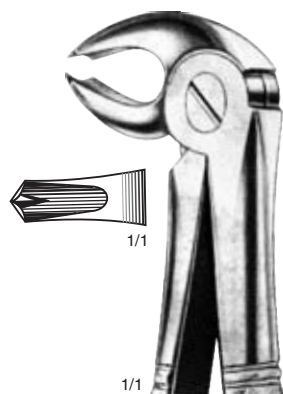

22
DC30-175-22
For Lower Molars-either side

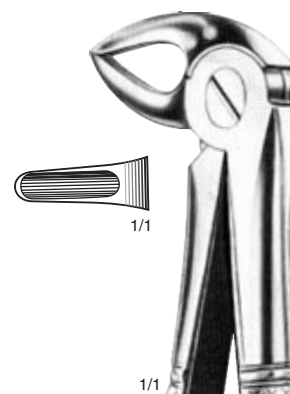

33
DC30-177-33
For Lower Roots-either side

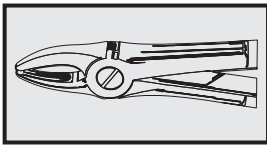

Extracting Forceps

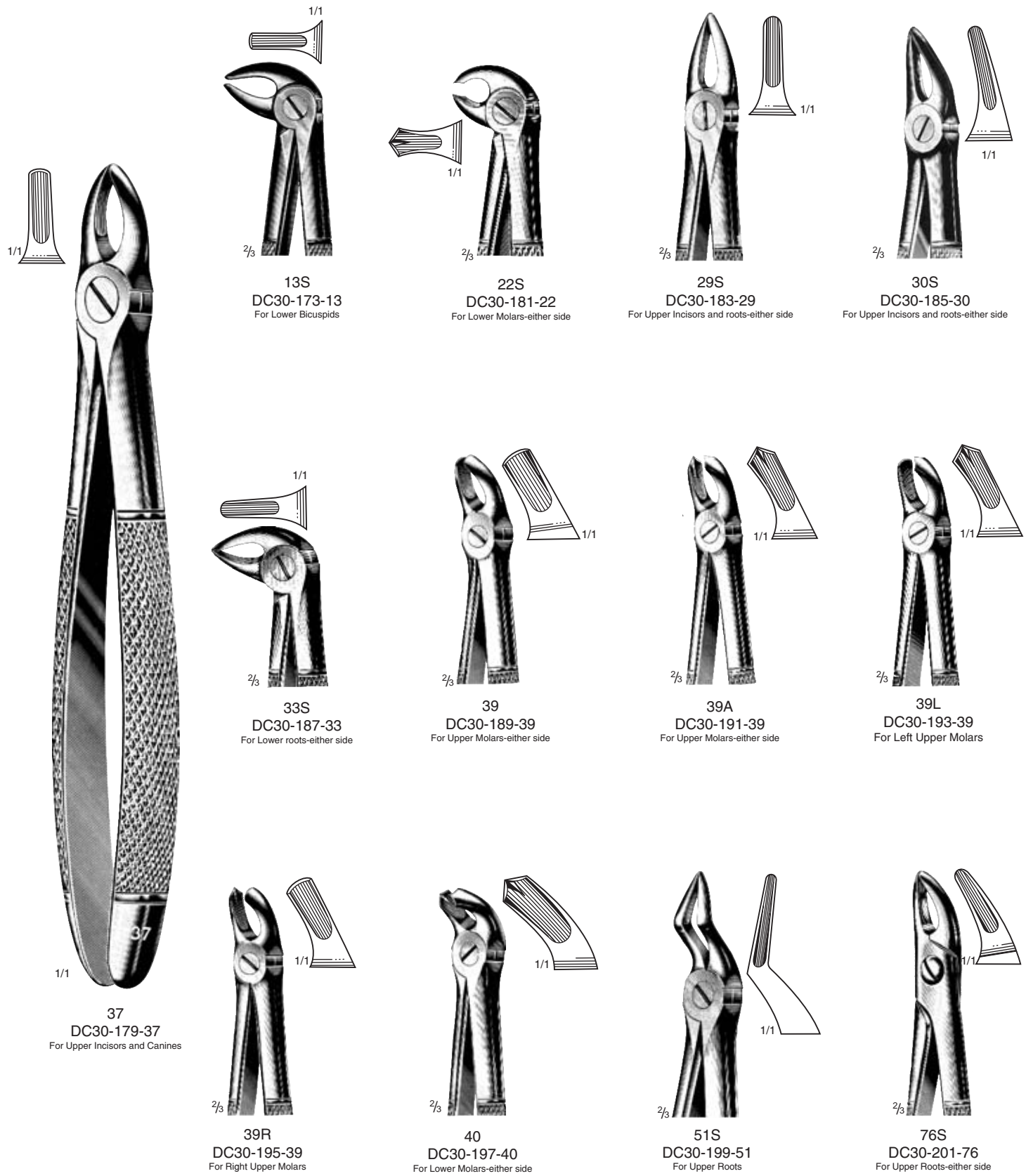

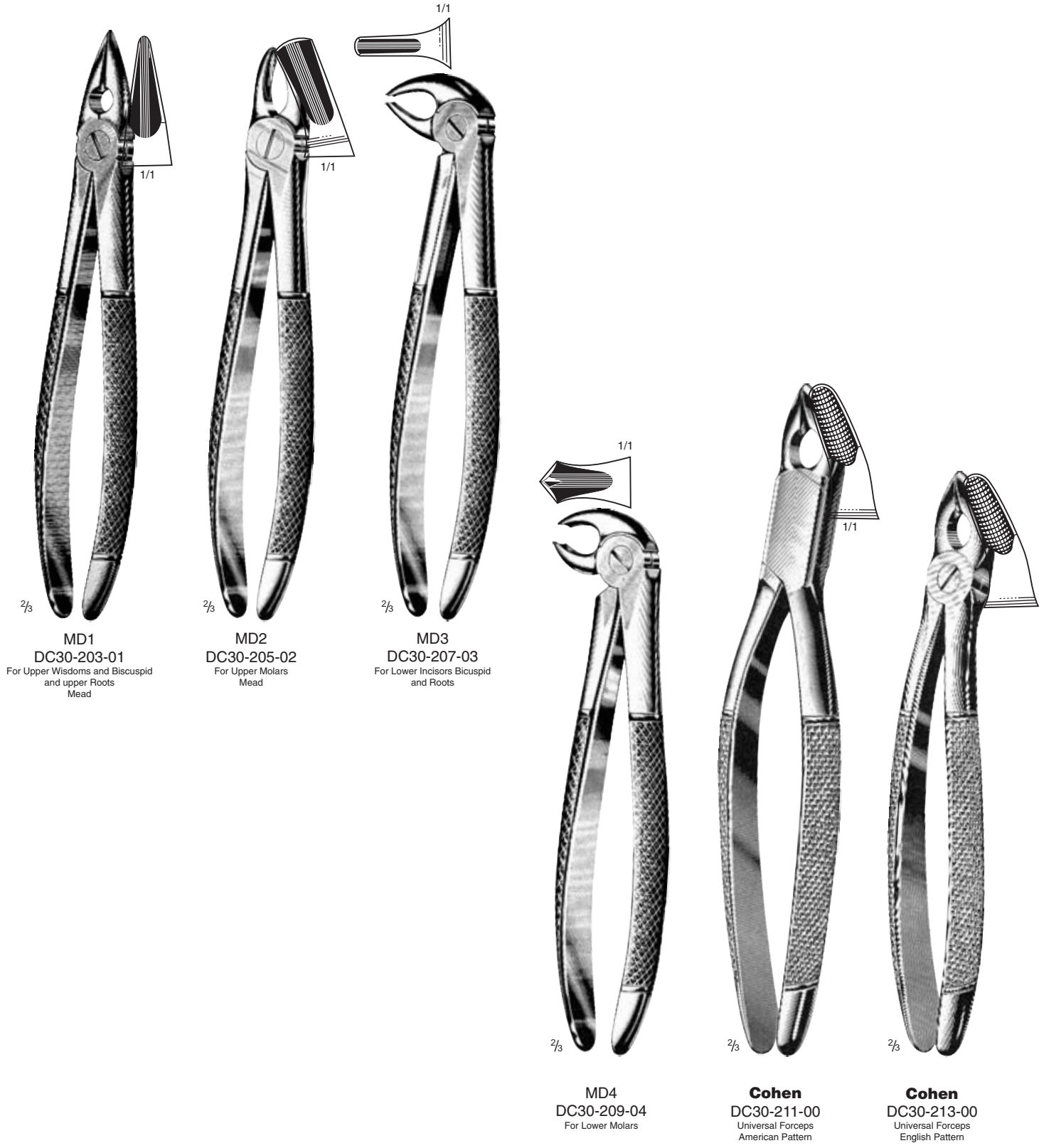
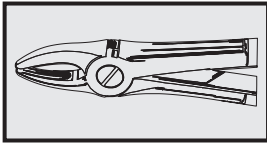

$\frac{2}{3}$
MD1
DC30-203-01
For Upper Wisdoms and Bicuspid
and upper Roots
Mead

$\frac{2}{3}$
MD2
DC30-205-02
For Upper Molars
Mead

$\frac{2}{3}$
MD3
DC30-207-03
For Lower Incisors Bicuspid
and Roots

$\frac{2}{3}$
MD4
DC30-209-04
For Lower Molars

$\frac{2}{3}$
Cohen
DC30-211-00
Universal Forceps
American Pattern

$\frac{2}{3}$
Cohen
DC30-213-00
Universal Forceps
English Pattern

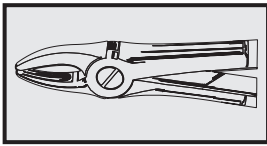

Wisdom Teeth Extracting Forceps

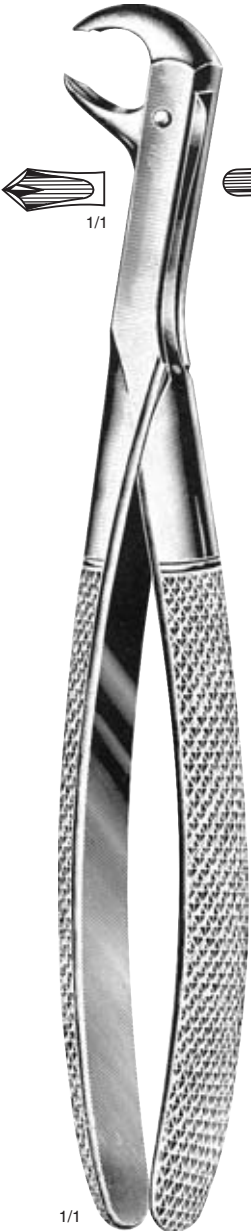

Stiksa
DC30-215-00
For Lower Wisdoms and Molars-either side

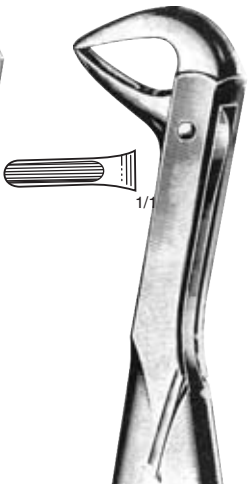

Stiksa
DC30-217-00
For Roots of Lower Molars and Wisdoms
either side

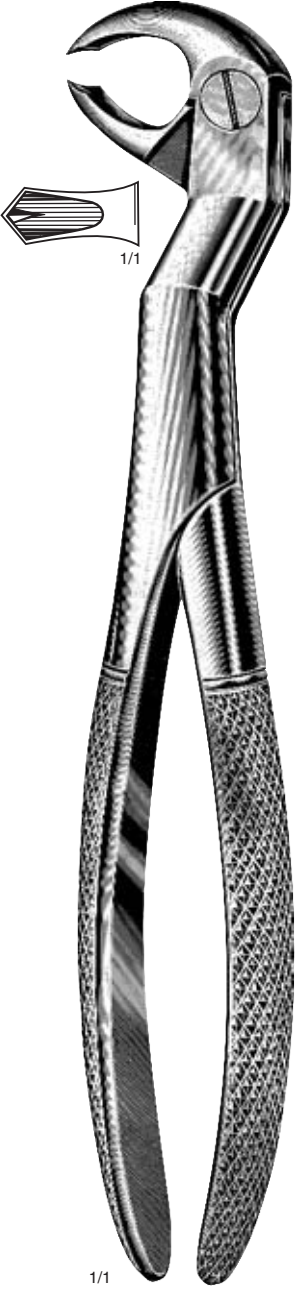

22 1/2 L
Wisdom-Routurier
DC30-219-22
For Left Lower Wisdoms and Molars



22 1/2 R
Wisdom-Routurier
DC30-221-22
For Right Lower Wisdoms and Molars



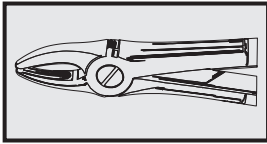

Extracting Forceps
For Children With Spring



1/1

3
Klein
DC30-223-03
For Upper Molars

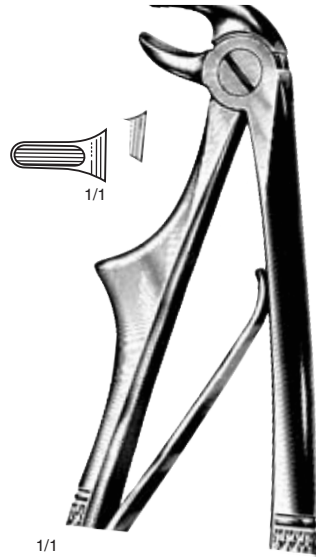

1/1

1/1

5
Klein
DC30-225-05
For Lower Incisors

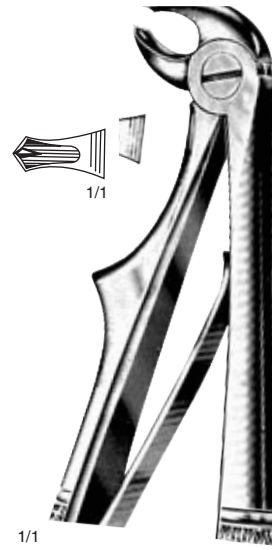

1/1

1/1

6
Klein
DC30-227-06
For Lower Molars

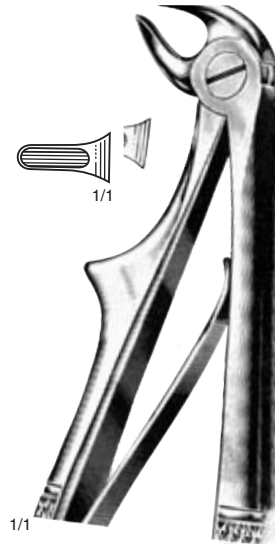

1/1

1/1

7
Klein
DC30-229-07
For Lower Roots



1/1

1/1

137
Klein
DC30-231-37
For Upper Incisors and Canines



1/1

1/1

139
Klein
DC30-233-39
For Upper Bicuspid

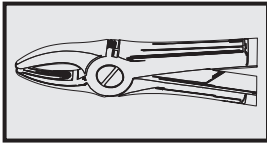

Extracting Forceps
For Children American Pattern



17SK
DC30-235-17
For Lower Molars-either side

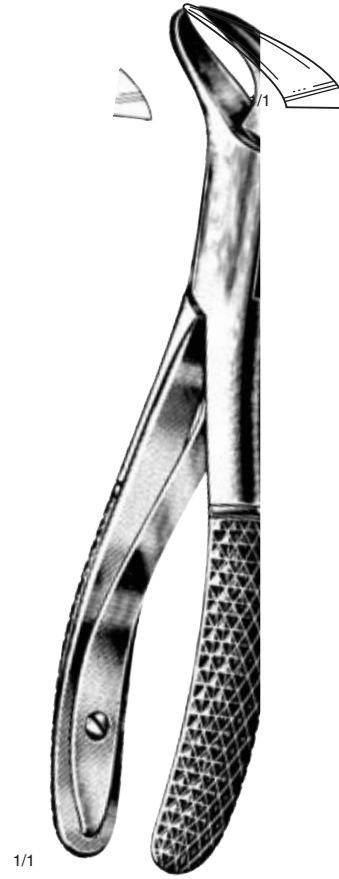

23SK
DC30-237-23
For Lower Molars-either side

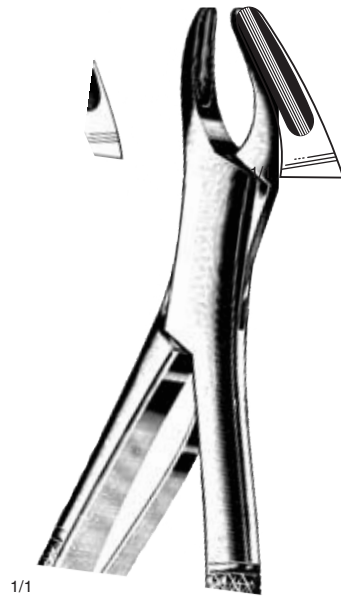

150SK
DC30-239-50
For Upper Teeth and Roots

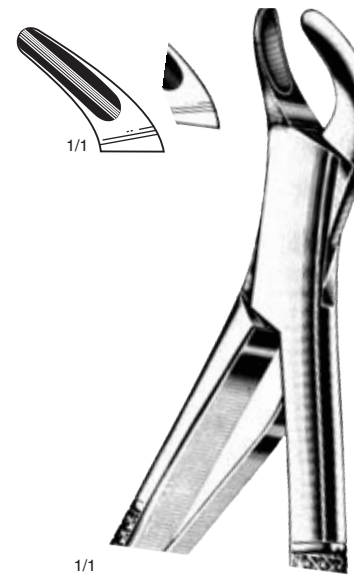

151SK
DC30-241-51
For Lower Teeth and Roots

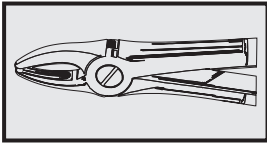

Extracting Forceps
American Pattern

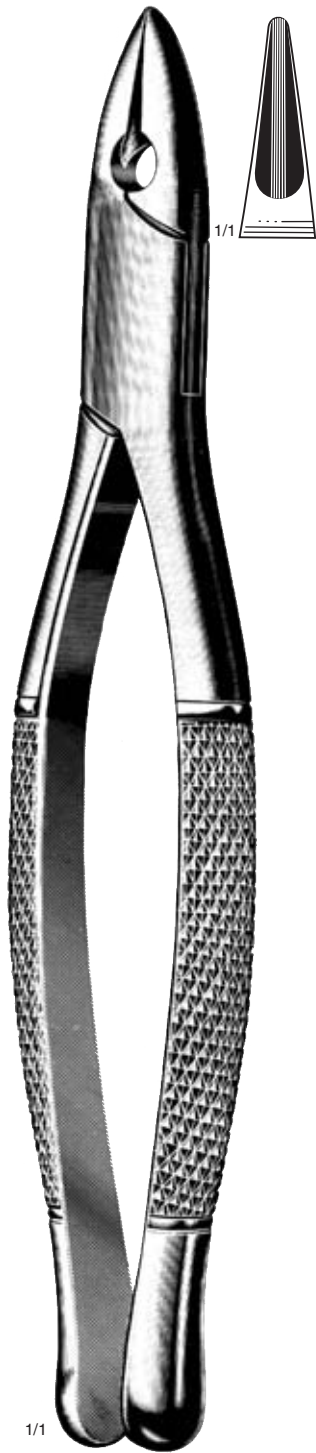

1
Standard
DC30-243-01
For Upper Central, Laterals and Cuspid

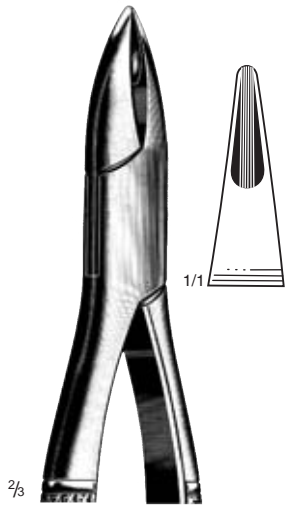

1A
Henahan
DC30-245-11
For Upper Incisors

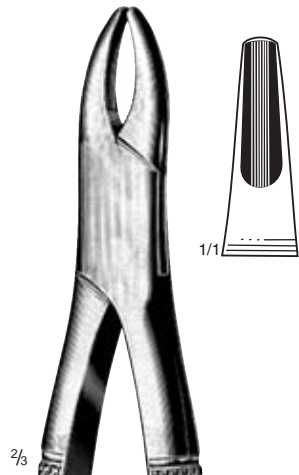

1B
Normal
DC30-249-12
For Upper Front Roots

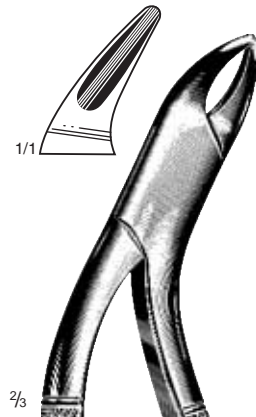

3
Milwaukee
DC30-247-03
For Lower Bicuspids

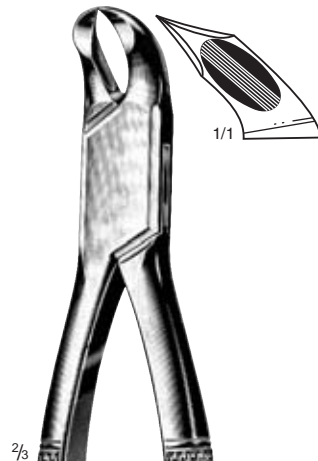

3FS
Woodward
DC30-251-03
For Lower Molars for
straight handles



3FH
Woodward
DC30-253-03
For Lower Molars with
hooked handles

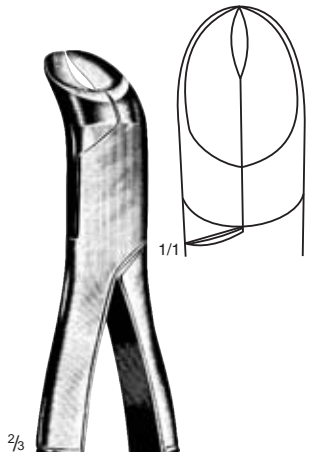

5
Physick
DC30-255-05
For Lower Third
Molars-either side

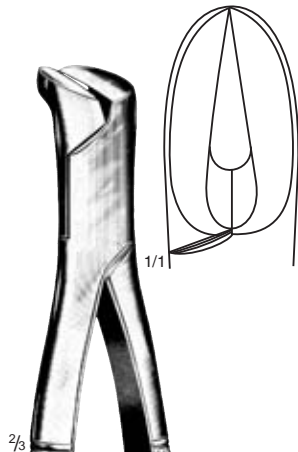

6
DC30-257-06
Splitting or Separating
Forceps

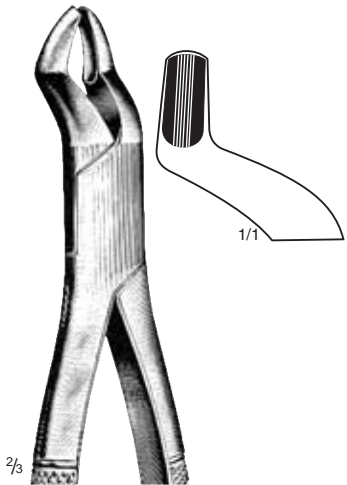

10H
DC30-259-10
For Upper Molars with
hooked Handles

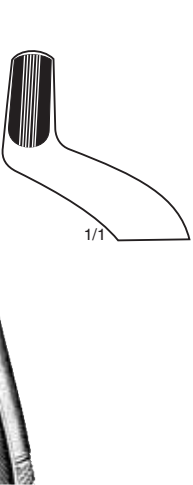

10S
DC30-261-10
For Upper Molars with
straight handles

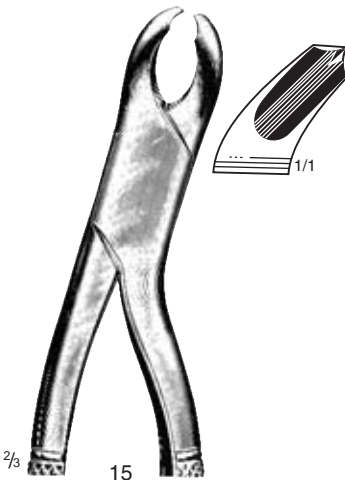

15
Harris
DC30-263-15
For Lower Molars for either-side
with hooked handles

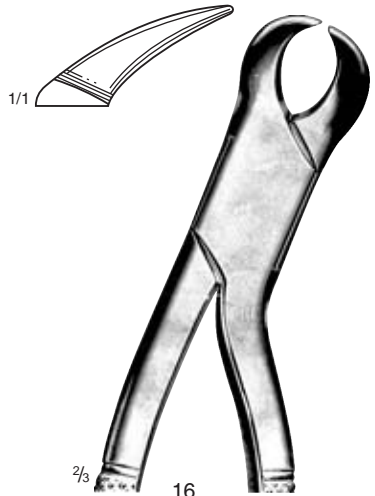

16
DC30-265-16
For Lower Molars

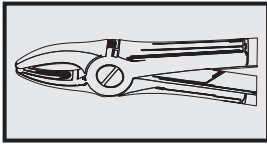

Extracting Forceps
American Pattern

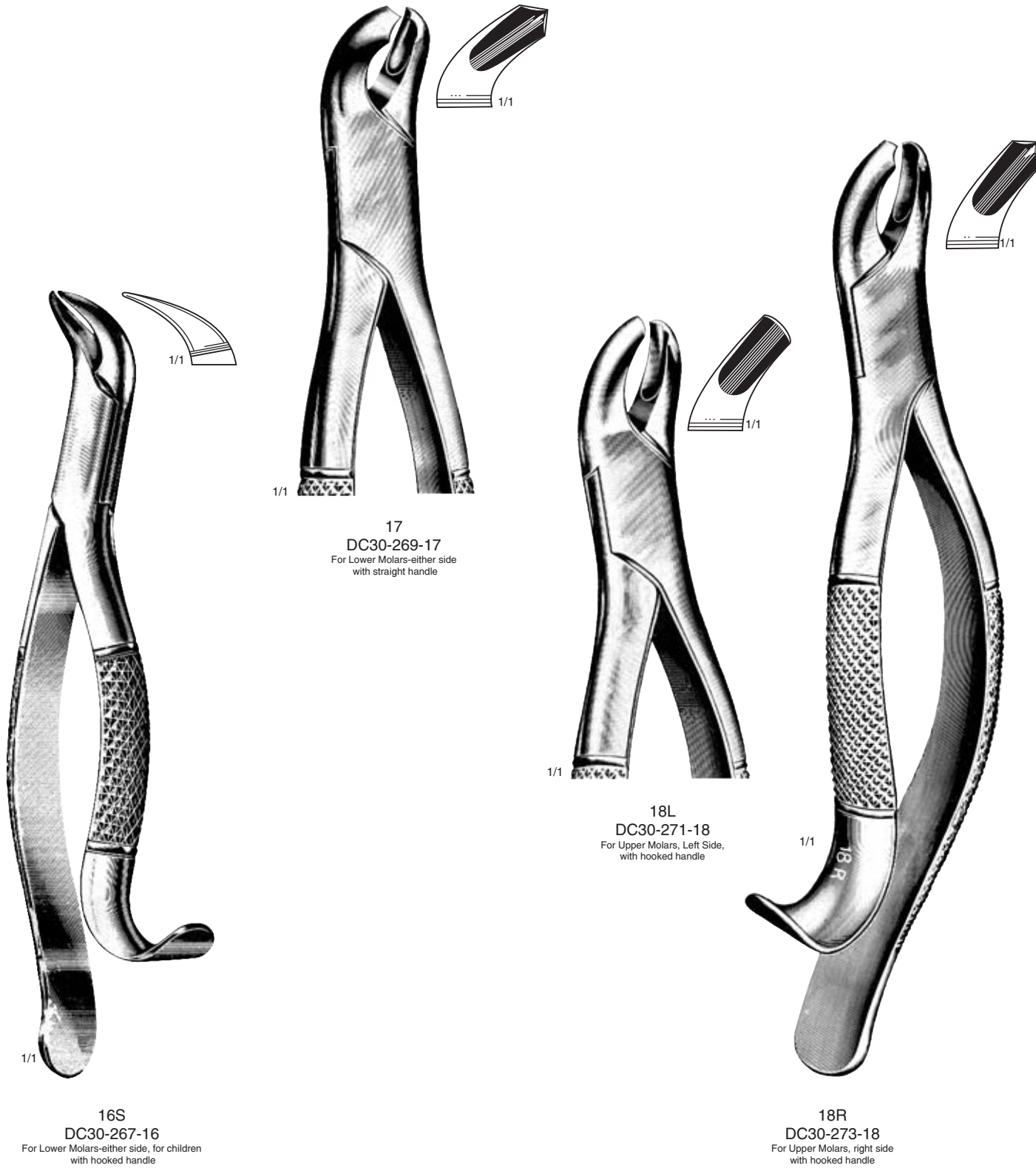

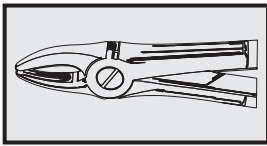

Extracting Forceps
American Pattern



23
DC30-275-23
For Lower Molars-either side
with straight handle

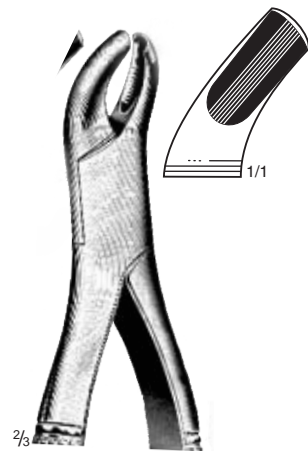

24
DC30-277-24
For Upper Molars-either side
hooked handle

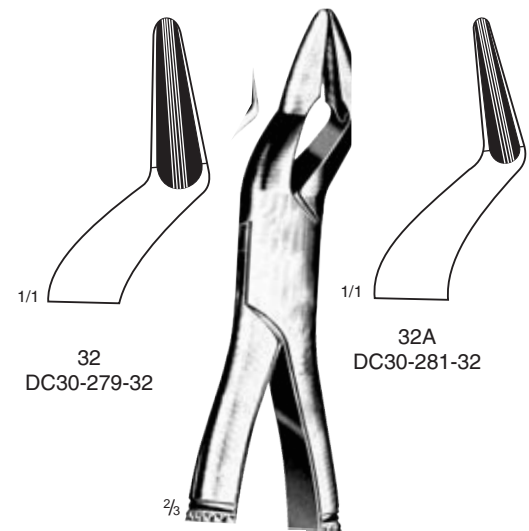

32
DC30-279-32
For Upper Molars and Bicuspids
with straight handle

32A
Parmly
DC30-281-32
For Upper Molars and Bicuspids
with straight handle

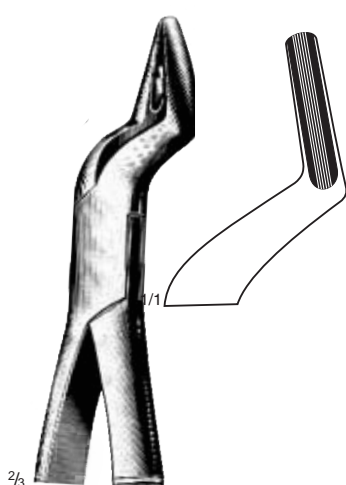

35
DC30-283-35
For Upper Roots-either side
with straight handle

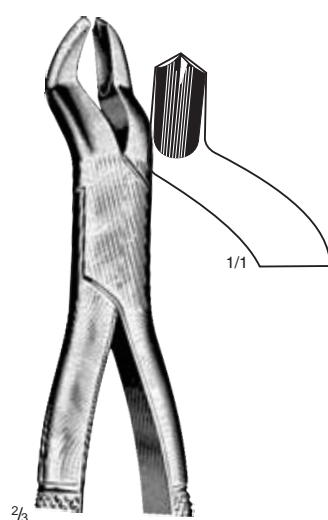

53L
DC30-285-53
For Upper Molars, Left side, with
straight handle

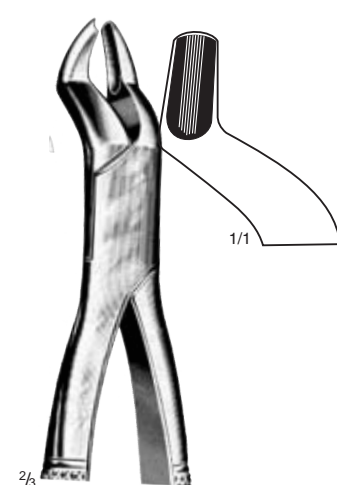

53R
DC30-287-53
For Upper Molars, right side, with
straight handle

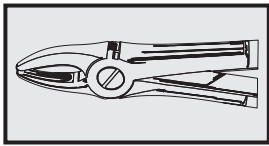

Extracting Forceps
American Pattern

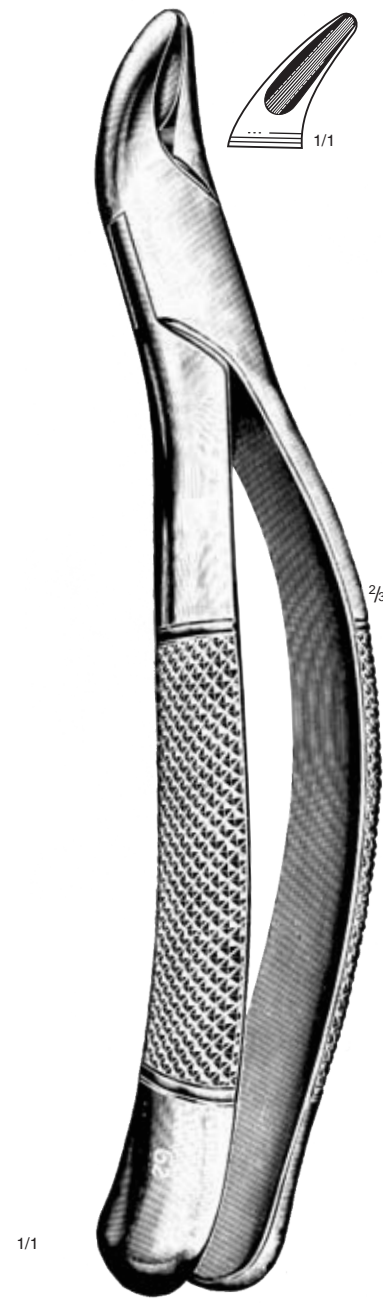

1/1
62
DC30-289-62
Universal Forceps, For Upper Teeth and Roots,
For Children, straight handle

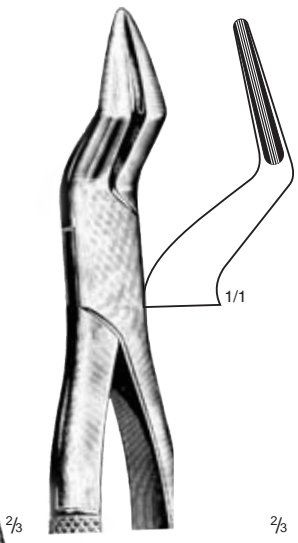
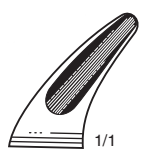

2/3
1/1
65
DC30-291-65
For Upper Incisors and Roots
Straight handle

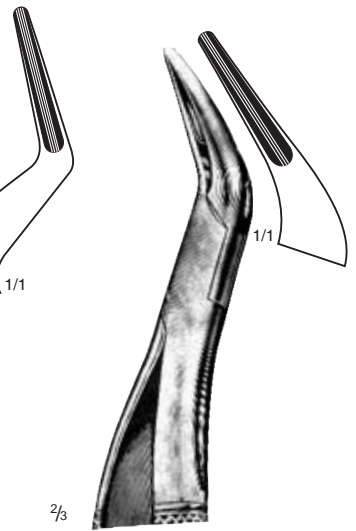

2/3
1/1
69
DC30-293-69
For Fragments and Small Roots, upper
and lower straight handle

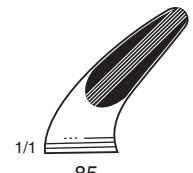

1/1
85
DC30-295-85
For Lower Molars, Cuspids
and Bicuspids
with hooked handle

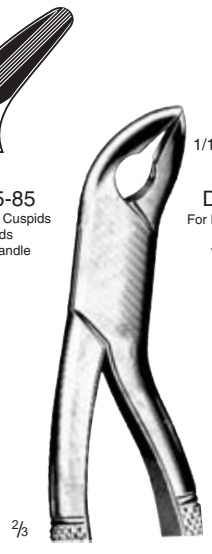

2/3
Thomas

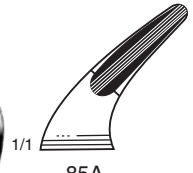

1/1
85A
DC30-297-85
For Lower Molars, Cuspids
and Bicuspids
with hooked handle

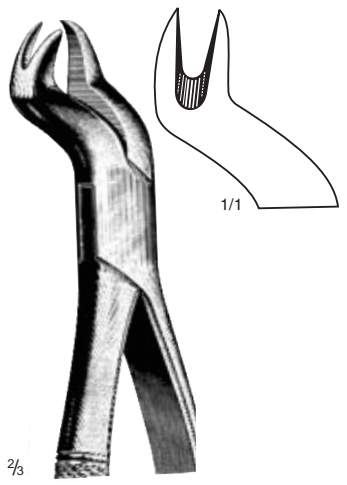

1/1
2/3
88L
DC30-299-88
For Left Upper Molars, with
straight handle

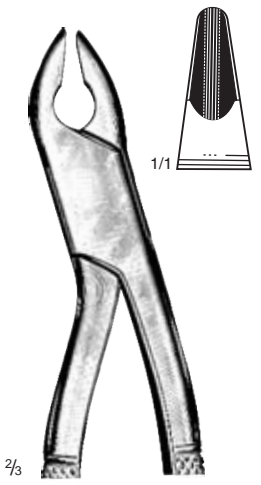

1/1
2/3
99A
Kells
DC30-301-99
For Upper Bicuspids, and Incisors
with hooked handle

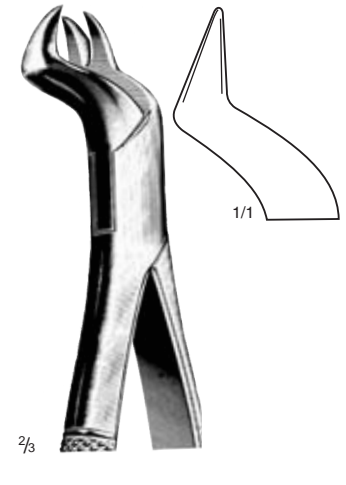

1/1
2/3
88R
DC30-303-88
For Right Upper Molars, with
straight handle

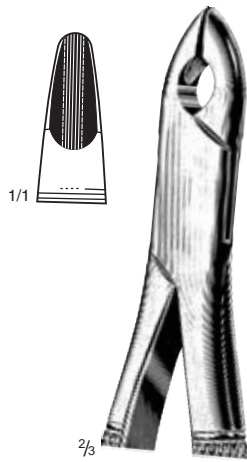
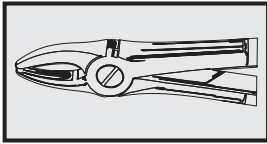

99C
Kells
DC30-305-99
For Upper Bicuspids, and Incisors
with straight handle

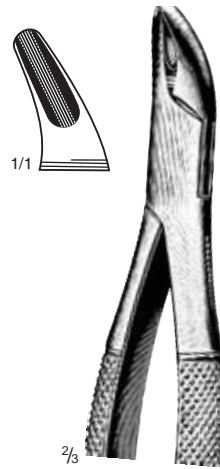

101
Hull
DC30-307-101
Universal Forceps for Bicuspids,
and Milk-Teeth, straight handle

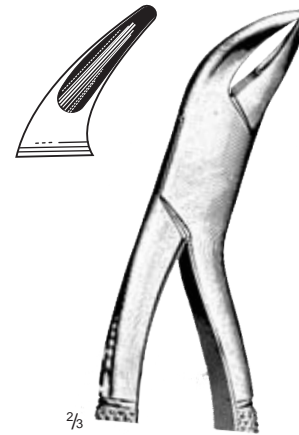

103
DC30-309-03
For Lower Bicuspids, Incisors and Roots-either
side hooked handle

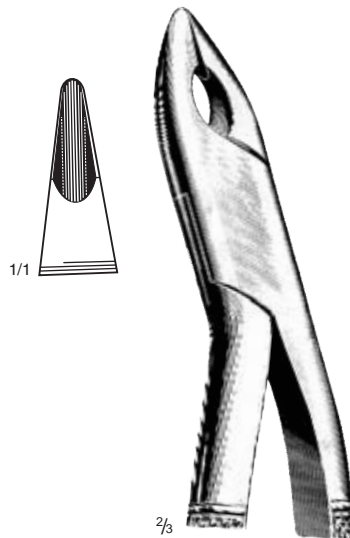

110
Nevius
DC30-311-10
For Upper Bicuspids and Cuspids
with hooked handle

DC30-313-01
For Upper Bicuspids and Cuspids
with straight handle

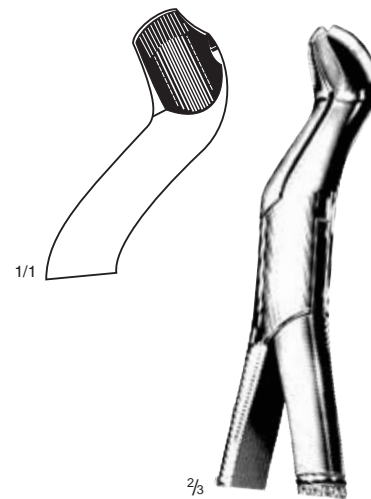

121
Felsch
DC30-315-21
For Upper Wisdoms with
straight handle

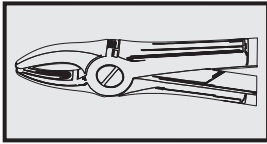

Extracting Forceps

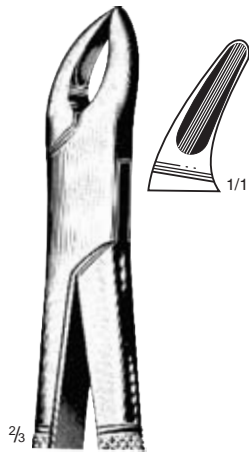

**150
Cryer**
DC30-317-50
For Upper Bicuspids Incisors and
Roots with straight handles

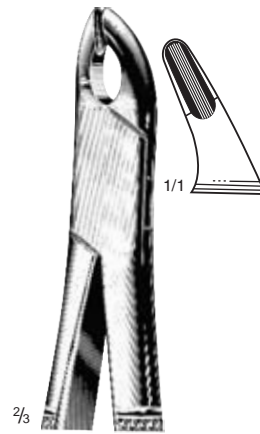

**150A
Cryer**
DC30-319-50
For Upper Bicuspids Incisors and
Roots with straight handle

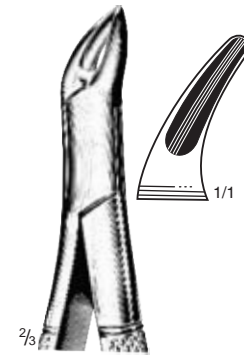

**150S
Cryer**
DC30-321-50
For Upper Bicuspids Incisors and
Roots with straight handle

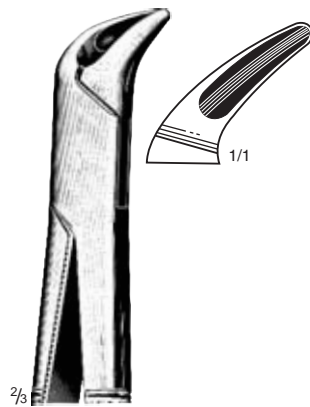

**151
Cryer**
DC30-323-51
For Upper Bicuspids Incisors and
Roots with straight handle

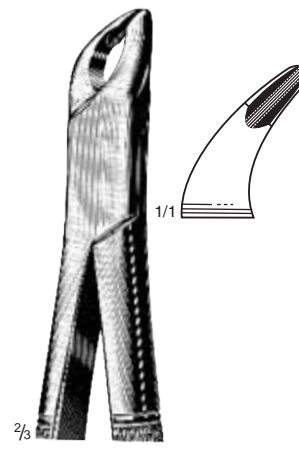

**151A
Cryer**
DC30-325-51
For Upper Bicuspids Incisors and
Roots with straight handle

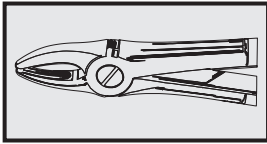

Extracting Forceps

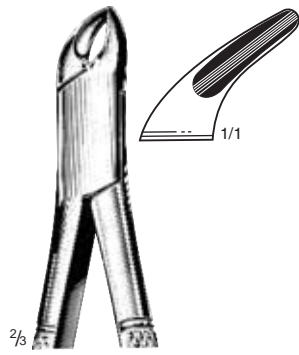

**151S
Cryer**
DC30-327-51
For Lower Bicuspid Incisors and
Roots with straight handle

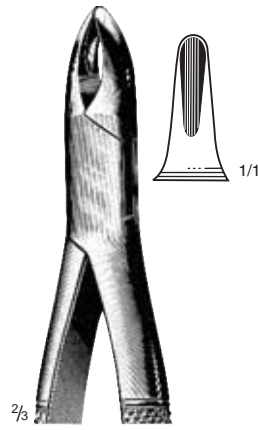

201
DC30-329-01
For Upper Bicuspid Cuspids and Incisors
with straight handle

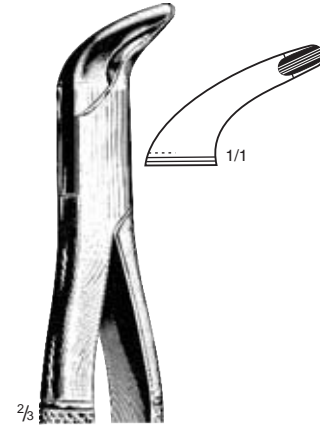

203
DC30-331-03
For Lower Bicuspid and Roots Incisors
with straight handle

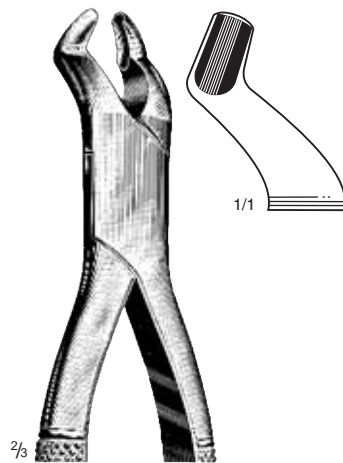

210H
DC30-333-10
For Upper Wisdoms-either side
with hooked handle

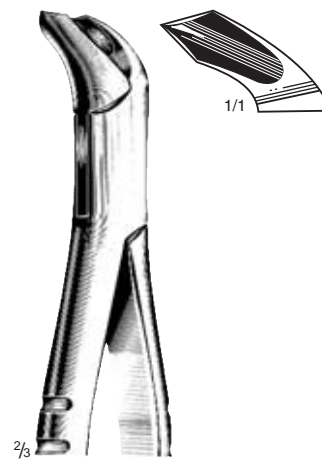

217
DC30-337-17
For Lower Molars-either side
with straight handle

210S
DC30-335-10
For Upper Wisdoms-either side
with straight handle

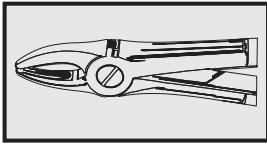

Extracting Forceps
American Pattern

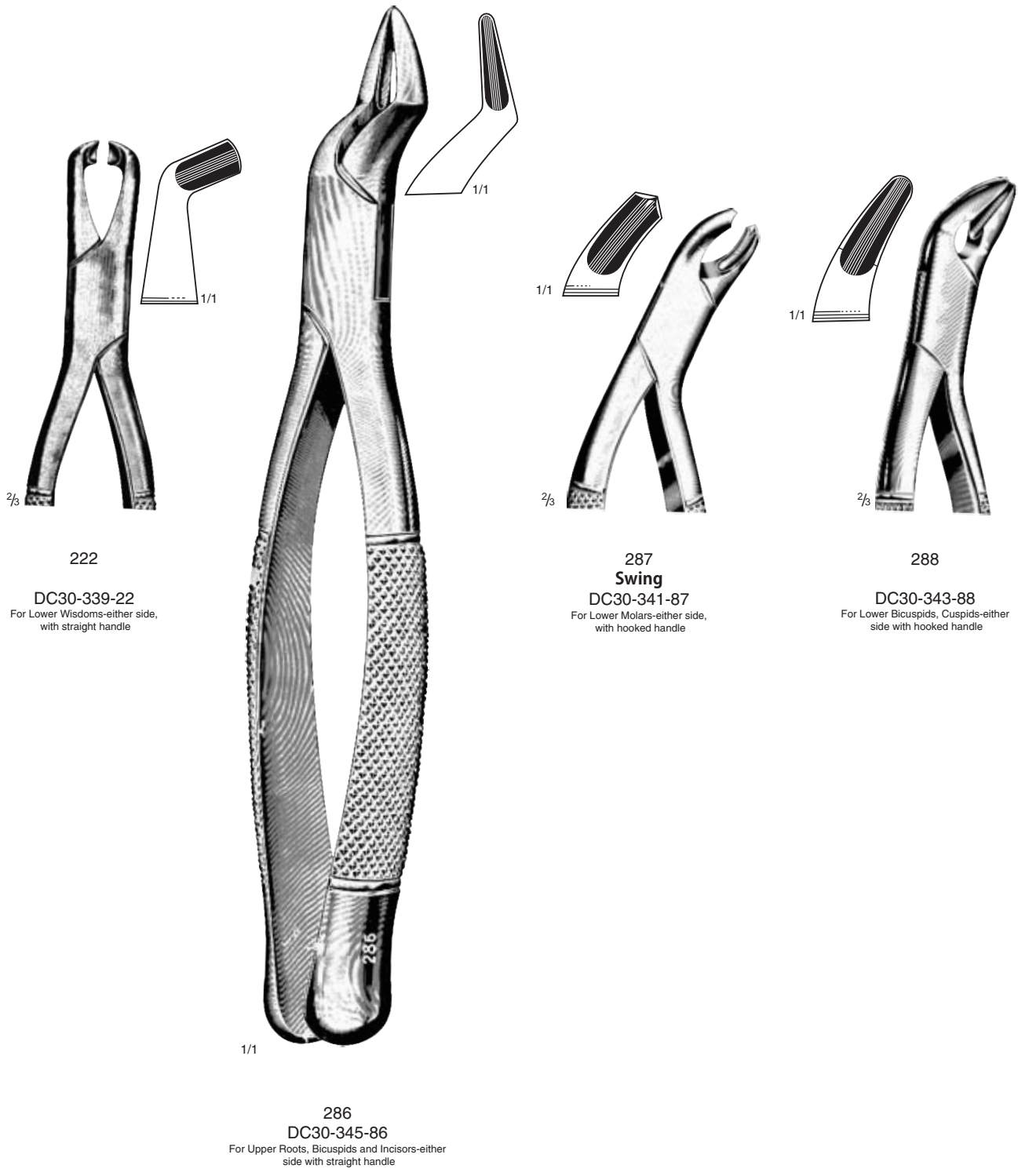

222
DC30-339-22
For Lower Wisdoms-either side,
with straight handle

286
DC30-345-86
For Upper Roots, Bicuspid and Incisors-either
side with straight handle

287
Swing
DC30-341-87
For Lower Molars-either side,
with hooked handle

288
DC30-343-88
For Lower Bicuspid, Cuspids-either
side with hooked handle

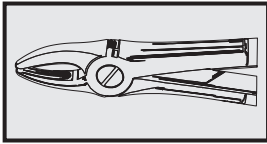

Root Fragment Forceps

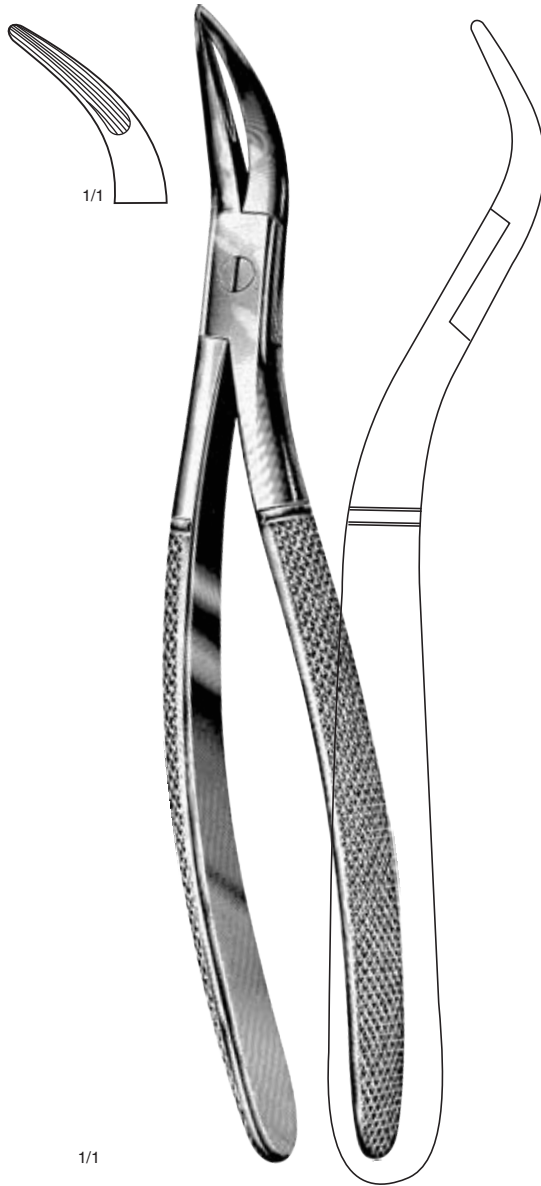

Witzel
DC30-347-00
Universal Pattern for Upper Teeth

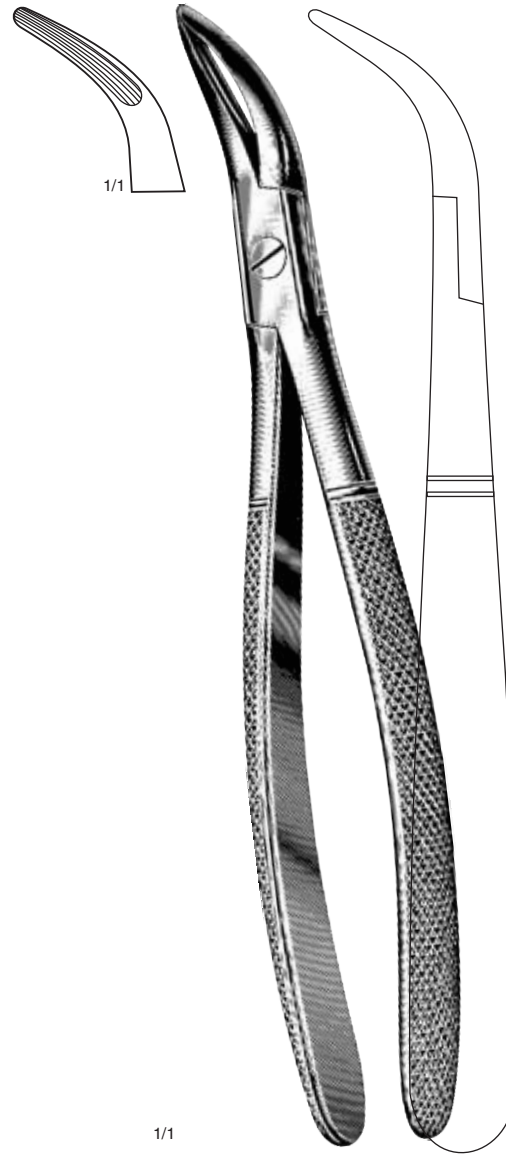

Witzel
DC30-349-00
Universal Pattern for Upper Teeth

7

RETRACTORES



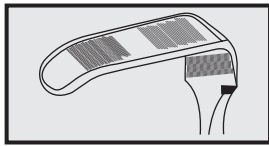

Retractors



Alm



a = 12 mm
b = 12 mm
c = 35 mm
DC31-009-10
DC31-013-10

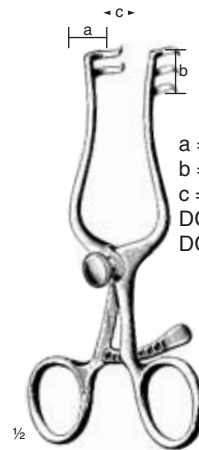

a = 16 mm
b = 18 mm
c = 55 mm
DC31-011-13
DC31-015-13

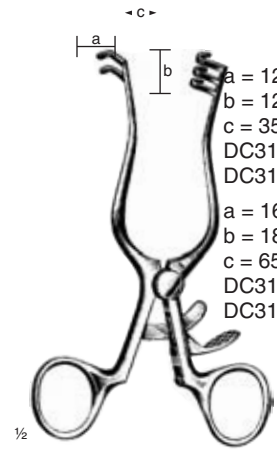

a = 12 mm
b = 12 mm
c = 35 mm
DC31-017-10
DC31-021-10
a = 16 mm
b = 18 mm
c = 65 mm
DC31-019-13
DC31-023-13

cm	in	Sharp	Blunt	Sharp	Blunt	Sharp	Blunt	Sharp	Blunt
7	2¾	DC31-001-07	DC31-003-07						
10	4	DC31-001-10	DC31-003-10	DC31-005-10	DC31-007-10	DC31-009-10	DC31-013-10	DC31-017-10	DC31-021-10
13	5					DC31-011-13	DC31-015-13	DC31-019-13	DC31-023-13

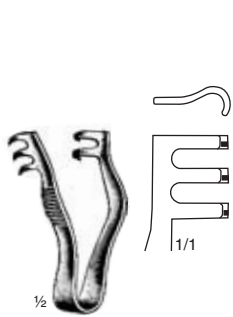

Finsen

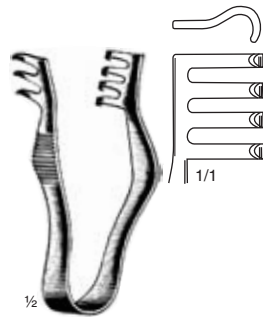

Finsen

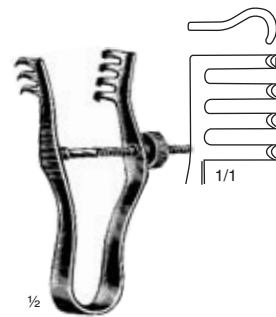

Finsen



Logan

Sharp	Blunt	Sharp	Blunt	Sharp	Blunt	Sharp
5 cm / 2"	5 cm / 2"	7 cm / 2¾"	7 cm / 2¾"	7 cm / 2¾"	7 cm / 2¾"	4 cm / 1½"
DC31-025-05	DC31-027-05	DC31-029-07	DC31-031-07	DC31-033-07	DC31-035-07	DC31-037-04

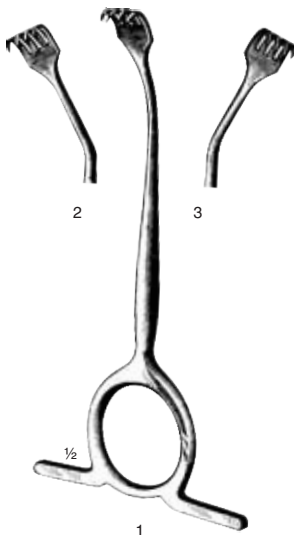

Williger



	Sharp	Blunt
1	DC31-039-03	DC31-045-04
2	DC31-041-03	DC31-047-04
3	DC31-043-03	DC31-049-04
	DC31-051-03	DC31-057-04
	DC31-053-03	DC31-059-04
	DC31-055-03	DC31-061-04

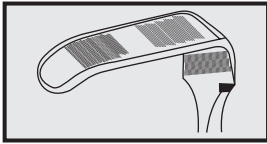

Retractors

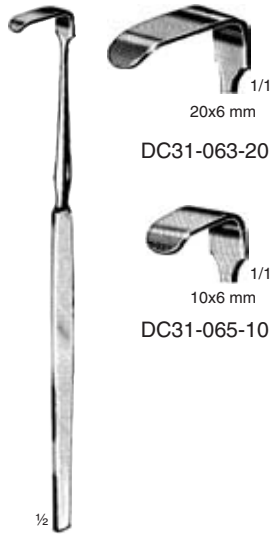

Senn-Green
15 cm / 6"

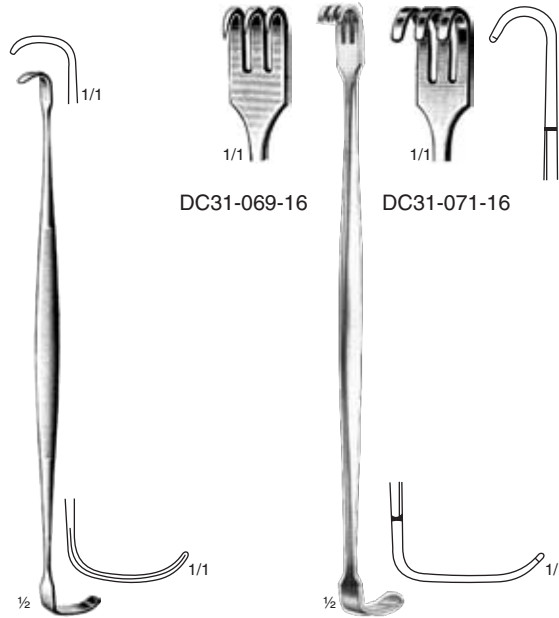

Ragnell-Davis
14 cm / 5½"
DC31-067-14

Senn-Mueller
16 cm / 6¼"

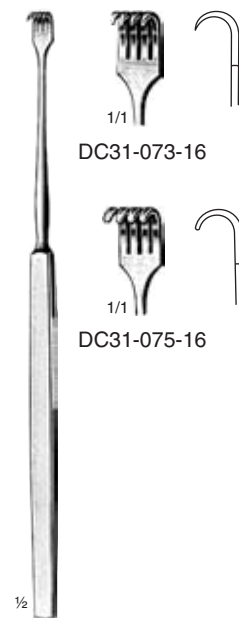

Klapp
16 cm / 6¼"

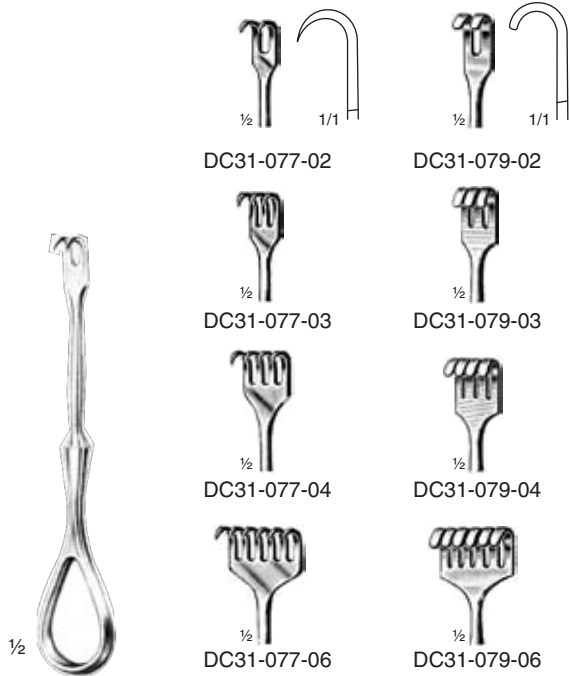

Volkman
11.5 cm / 4½"

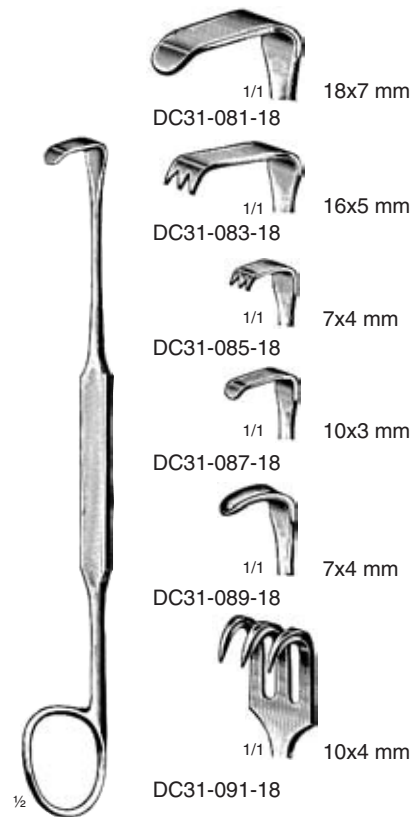

Meyerding
18 cm / 7"

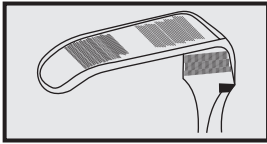

Retractors

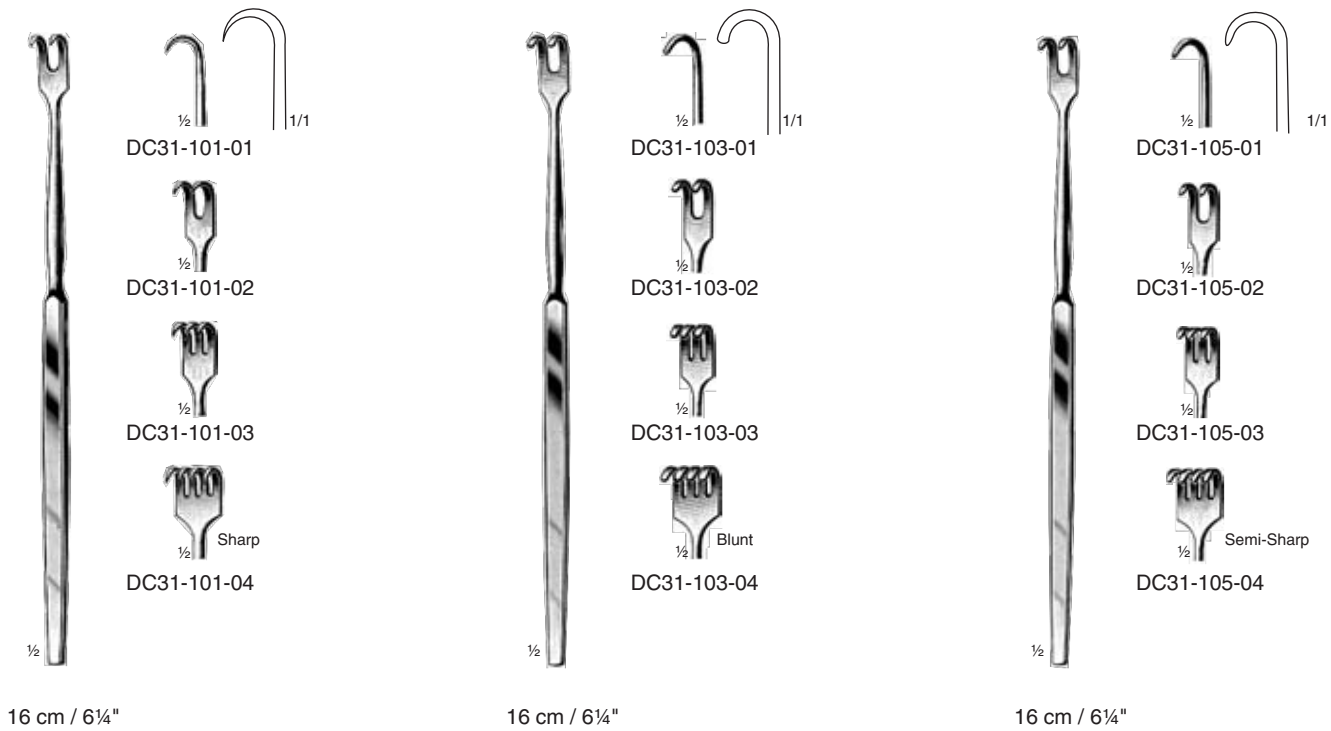
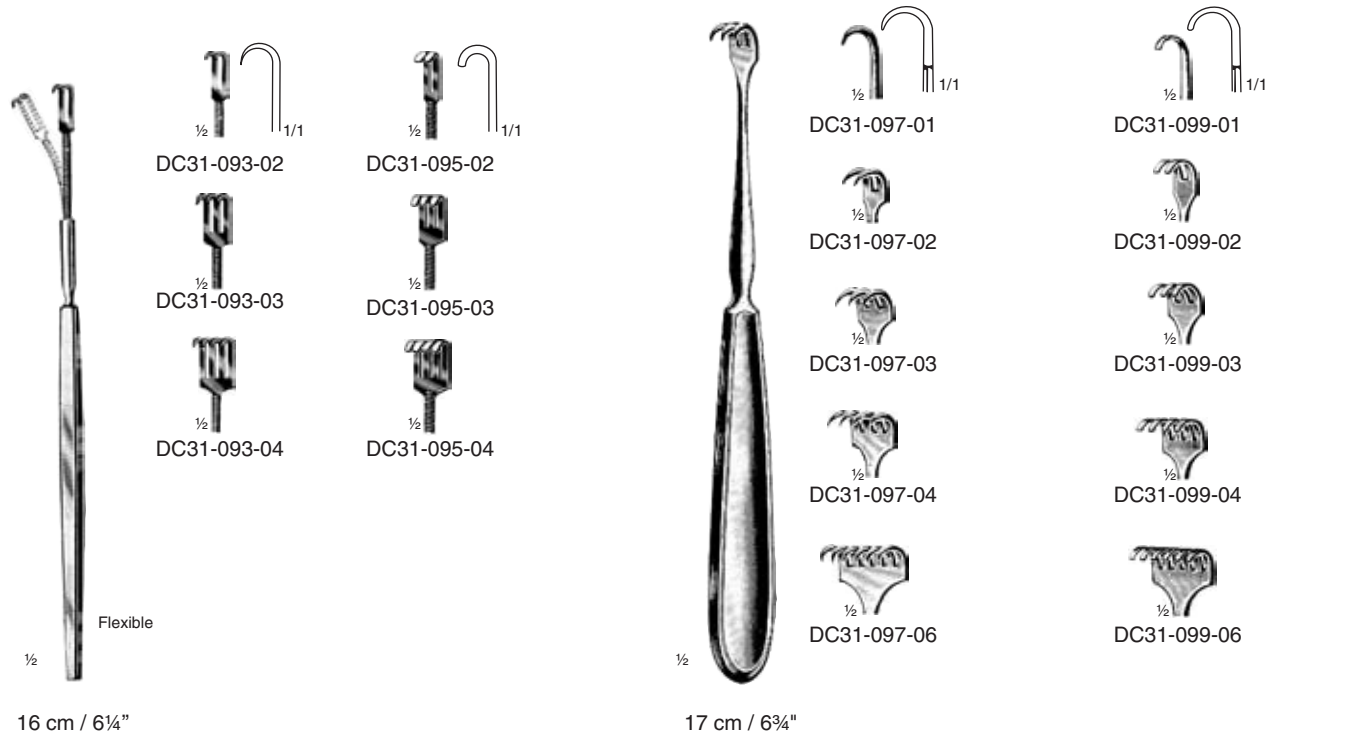

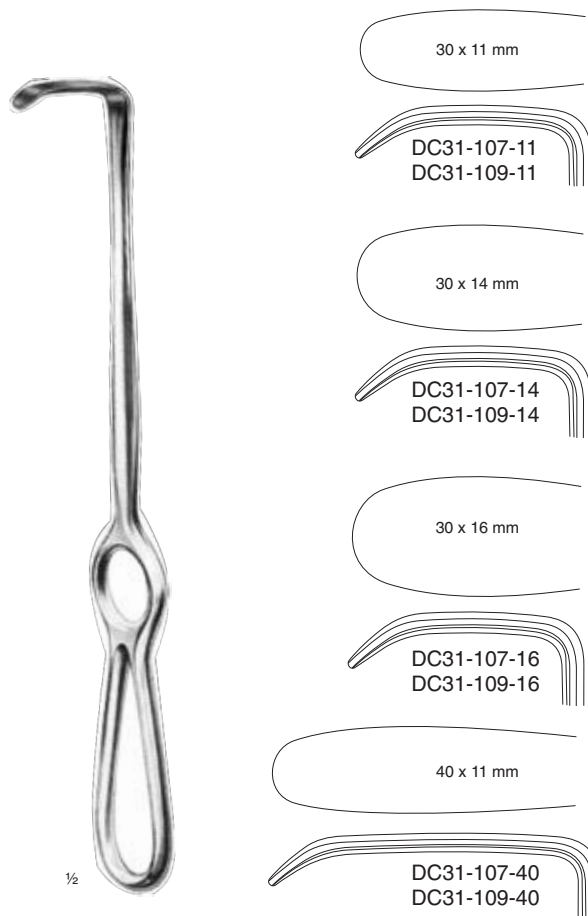
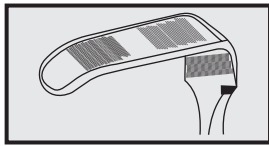

Langenbeck
21 cm / 8¼"
DC31-107-00



Langenbeck
21 cm / 8¼"

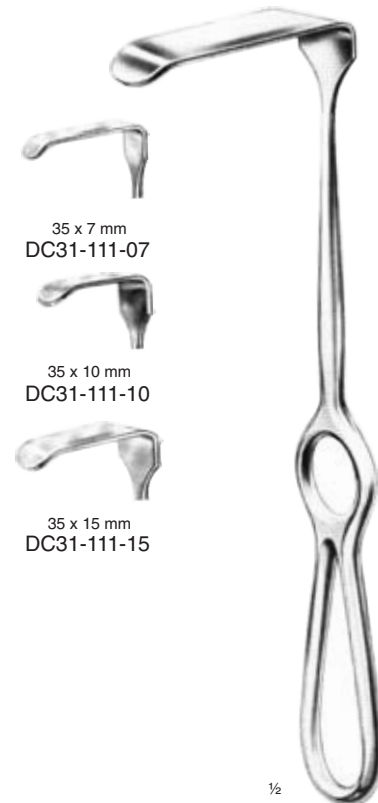

Langenbeck
22 cm / 8½"
DC31-111-22

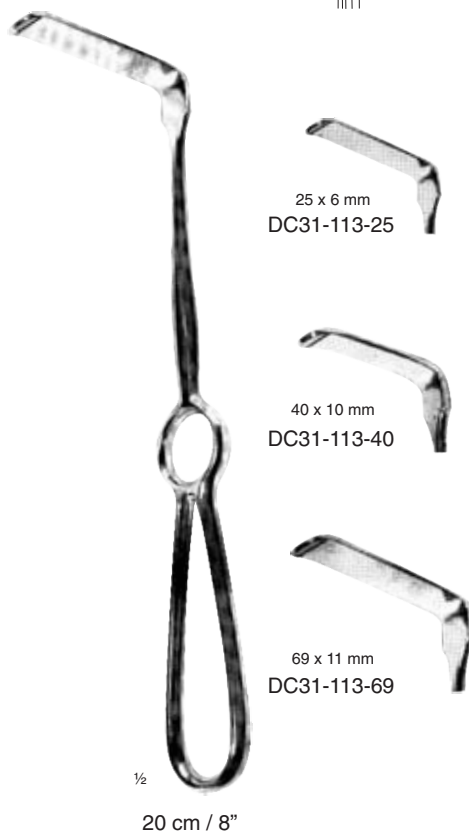

20 cm / 8"

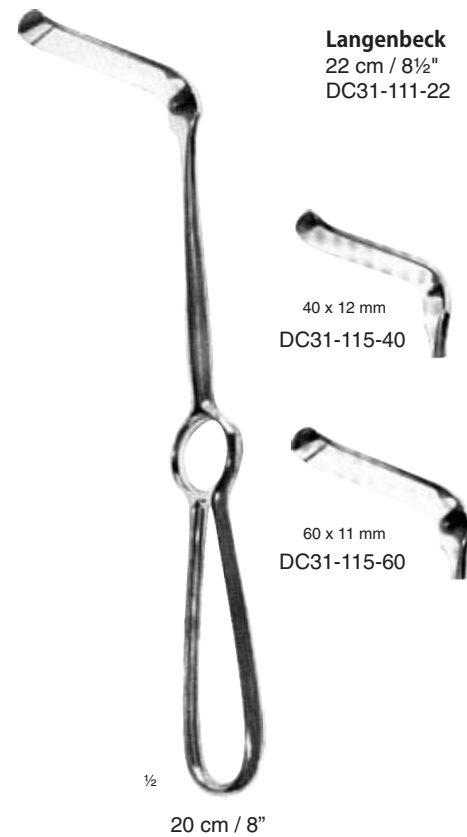

20 cm / 8"

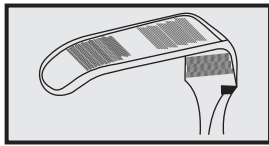

Retractors

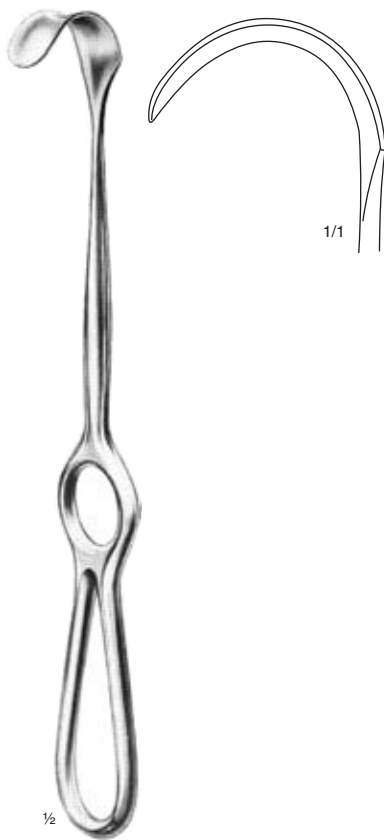

Kocher
22 cm / 8³/₄"
40 x 10 mm
DC31-117-10
40 x 15 mm
DC31-119-15

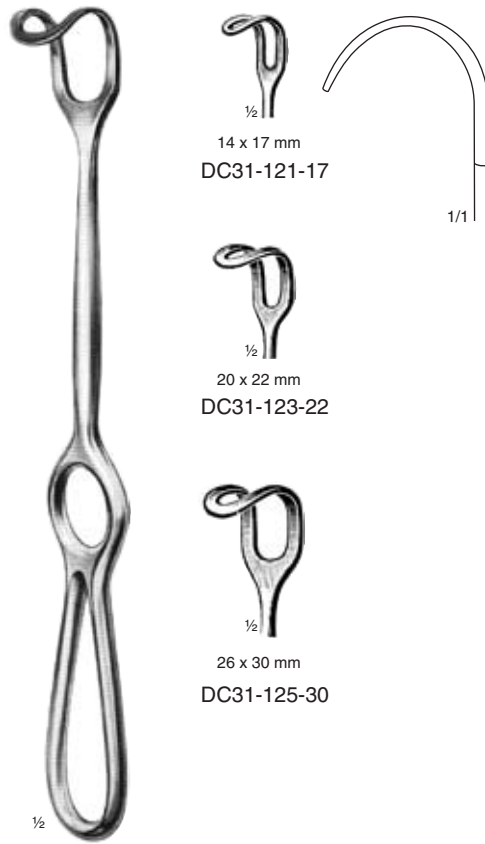

Middeldorpf

14 x 17 mm
DC31-121-17

20 x 22 mm
DC31-123-22

26 x 30 mm
DC31-125-30

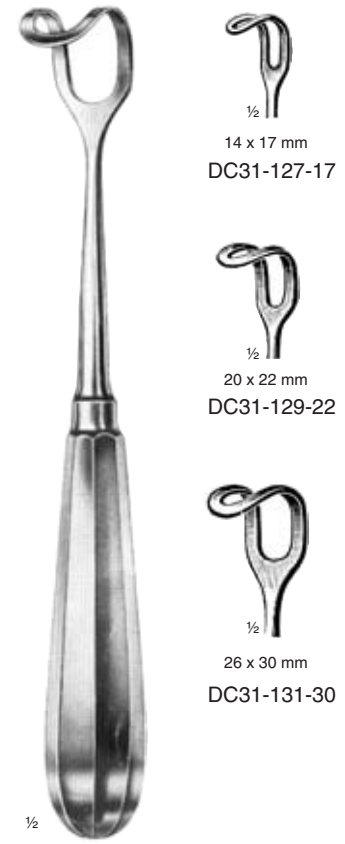

Middeldorpf

14 x 17 mm
DC31-127-17

20 x 22 mm
DC31-129-22

26 x 30 mm
DC31-131-30



DC31-133-01



DC31-135-01



Shann
DC31-137-01

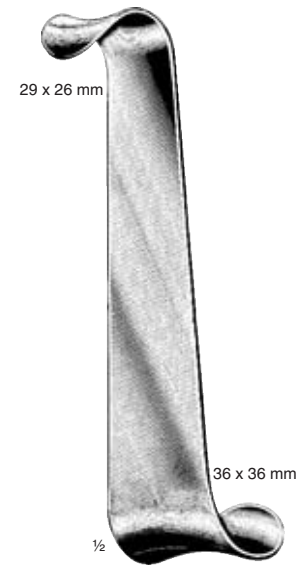

Roux Magnus
DC31-139-01

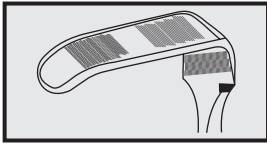

Retractors



DC31-141-01 # 1
25 x 6 mm



DC31-141-02 # 2
25 x 8 mm



DC31-141-03 # 3
35 x 8 mm



$\frac{1}{4}$ DC31-141-04 # 4
35 x 11 mm



DC31-141-05 # 5
35 x 15 mm



DC31-141-06 # 6
40 x 11 mm



DC31-141-07 # 7
55 x 11 mm



DC31-141-08 # 8
70 x 14 mm



DC31-141-09 # 9
80 x 12 mm



$\frac{1}{4}$ DC31-141-10 # 10
80 x 16 mm



$\frac{1}{2}$
Kocher-Langenbeck
21.5cm/8 $\frac{1}{2}$ "

also available in special sizes

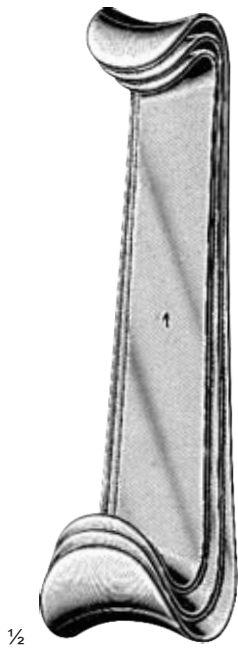
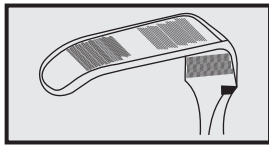

1/2

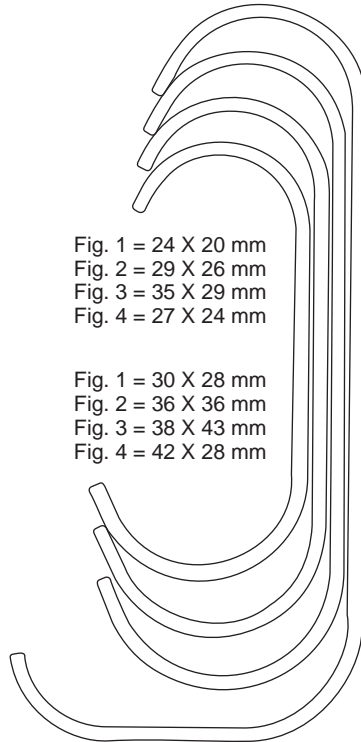

Fig. 1 = 24 X 20 mm
 Fig. 2 = 29 X 26 mm
 Fig. 3 = 35 X 29 mm
 Fig. 4 = 27 X 24 mm

Fig. 1 = 30 X 28 mm
 Fig. 2 = 36 X 36 mm
 Fig. 3 = 38 X 43 mm
 Fig. 4 = 42 X 28 mm

Roux

DC31-143-00 = Set Fig. 1-3
 DC31-143-01 = Fig. 1 = 14 cm/5 1/2"
 DC31-143-02 = Fig. 2 = 15 cm/6"
 DC31-143-03 = Fig. 3 = 17 cm/6 3/4"
 DC31-143-04 = Fig. 4 = 18 cm/7"

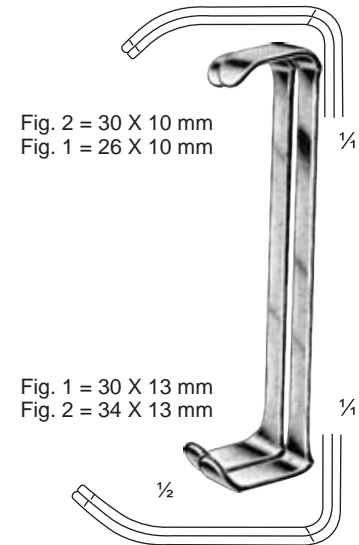

Fig. 2 = 30 X 10 mm
 Fig. 1 = 26 X 10 mm

Fig. 1 = 30 X 13 mm
 Fig. 2 = 34 X 13 mm

Farabeuf

DC31-145-00 = Set
 DC31-145-01 = Fig. 1
 DC31-145-02 = Fig. 2
 12 cm/4 3/4"

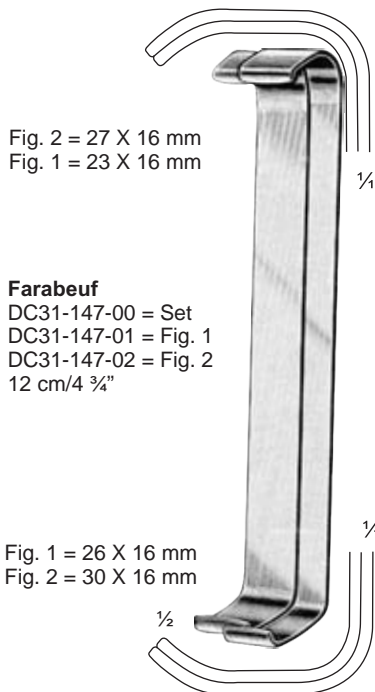
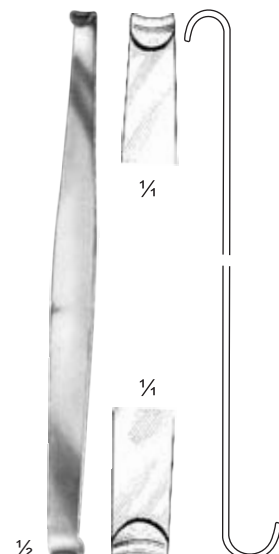

Fig. 2 = 27 X 16 mm
 Fig. 1 = 23 X 16 mm

Farabeuf

DC31-147-00 = Set
 DC31-147-01 = Fig. 1
 DC31-147-02 = Fig. 2
 12 cm/4 3/4"

Fig. 1 = 26 X 16 mm
 Fig. 2 = 30 X 16 mm



Mini-Roux
 DC31-149-06

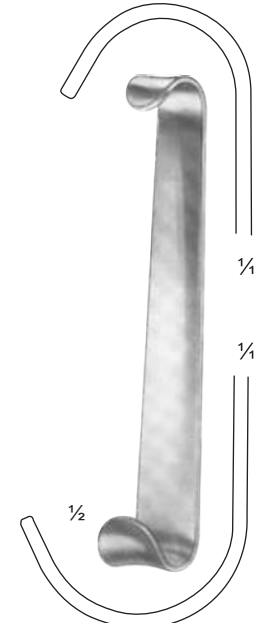

Baby-Roux
 DC31-151-13
 13 cm/5 1/4"

8

SUTURAS, TUBOS DE SUCCIÓN Y HERRAMIENTAS DE MEDICIÓN



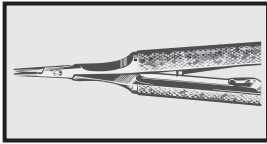

Reverdin

Reverdin

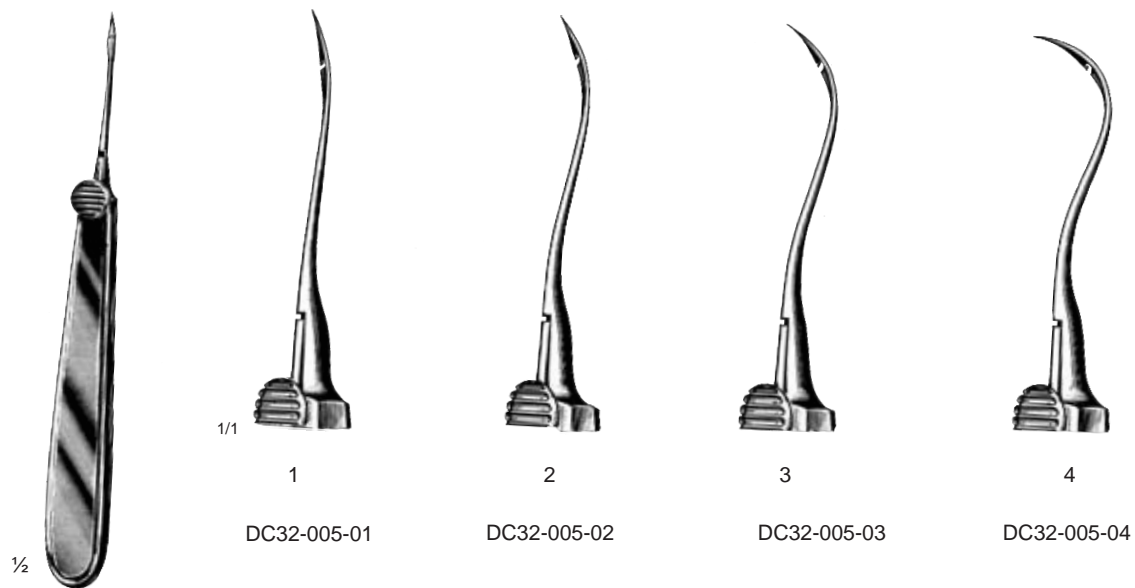

Reverdin
14 cm / 5 $\frac{1}{2}$ "

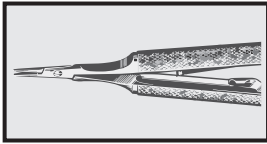

Needle Holders

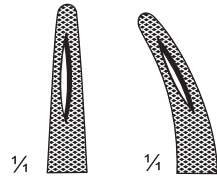
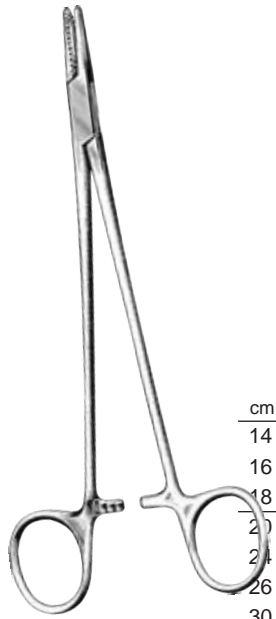

cm	in.	straight	curved
14	5 1/2	DC32-007-14	
16	6 1/4	DC32-007-16	DC32-009-16
18	7	DC32-007-18	DC32-009-18
20	8	DC32-007-20	DC32-009-20
24	9 1/2	DC32-007-24	DC32-009-24
26	10 1/4	DC32-007-26	DC32-009-26
30	12	DC32-007-30	

Mayo-Hegar

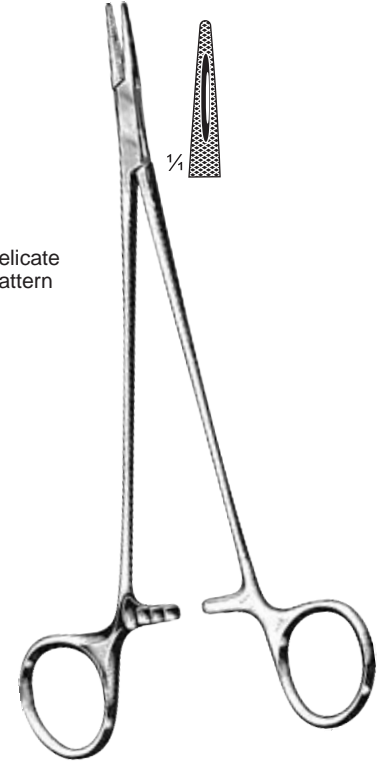

delicate pattern

Mayo-Hegar
 DC32-011-16 = 16cm/6 1/4"
 DC32-011-18 = 18cm/7"
 DC32-011-20 = 30cm/8"

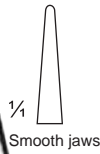
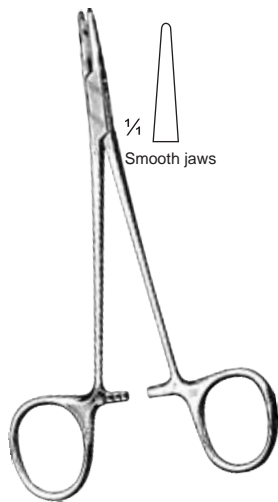

1/2

Halsey
 DC32-013-13
 13 cm / 5"

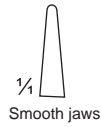
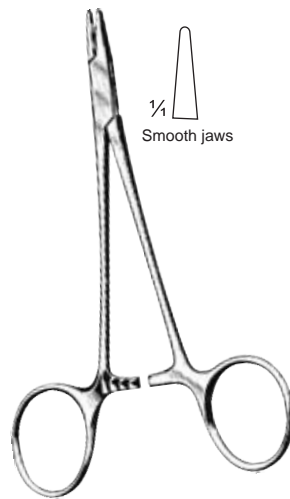

1/2

Webster
 DC32-015-13
 13 cm / 5"

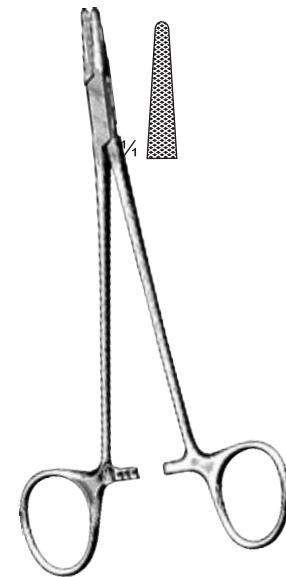

Crile-Murray
 DC32-017-15
 15 cm / 6"

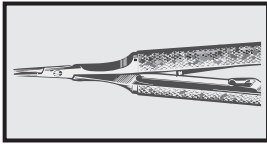

Needle Holders



Crile-Wood
DC32-019-15
15 cm / 6"



Crile
DC32-021-15
15 cm / 6"



Toennis
DC32-023-18
18 cm / 7"

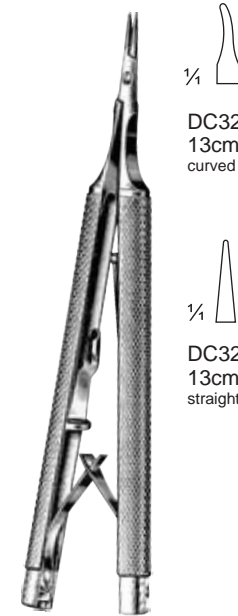

Castroviejo

1/4
DC32-025-13
13cm/5"
curved

1/4
DC32-025-13
13cm/5"
straight



Mathieu
DC32-027-14 = 14 cm / 5 1/2"
DC32-027-17 = 17 cm / 6 3/4"

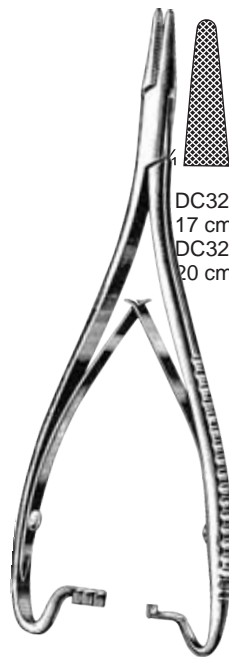

Mathieu



DC32-029-17
17 cm / 6 3/4"
DC32-029-20
20 cm / 8"

DC32-031-17
17 cm / 6 3/4"
DC32-031-20
20 cm / 8"

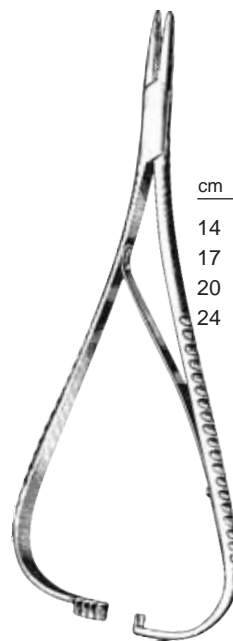

Mathieu

cm	in.	D	D
14	5 1/2	DC32-033-14	DC32-035-14
17	6 3/4	DC32-033-17	DC32-035-17
20	7	DC32-033-20	DC32-035-20
24	9 1/2	DC32-033-24	DC32-035-24

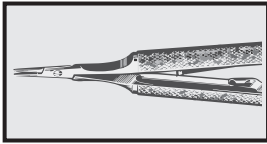

Needle Holders

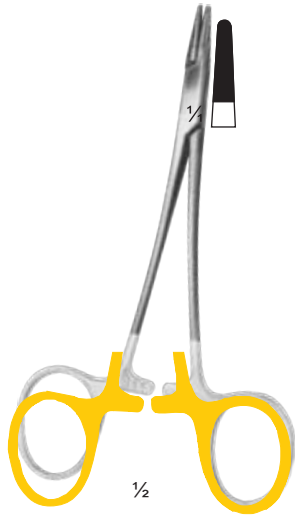

Webster
DC32-037-13
13cm/5"



Baumgartner
DC32-039-13
13cm/5"



Derf (Halsey)
DC32-041-12
12cm/4 3/4"



Derf (Halsey)



Crile-Wood

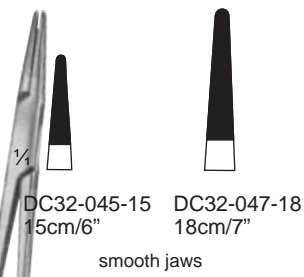

New Orleans

DC32-049-18
18cm/7"

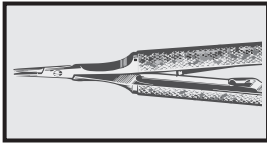

Needle Holders

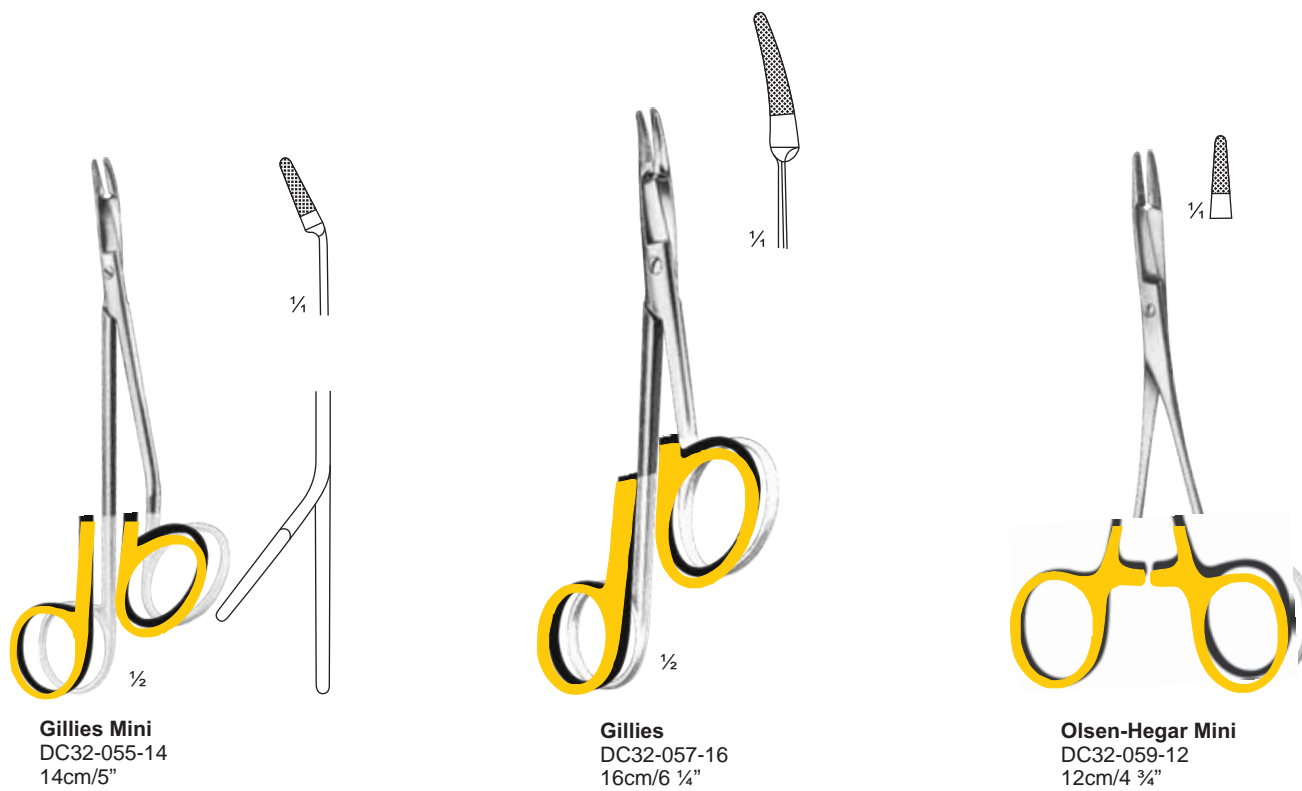
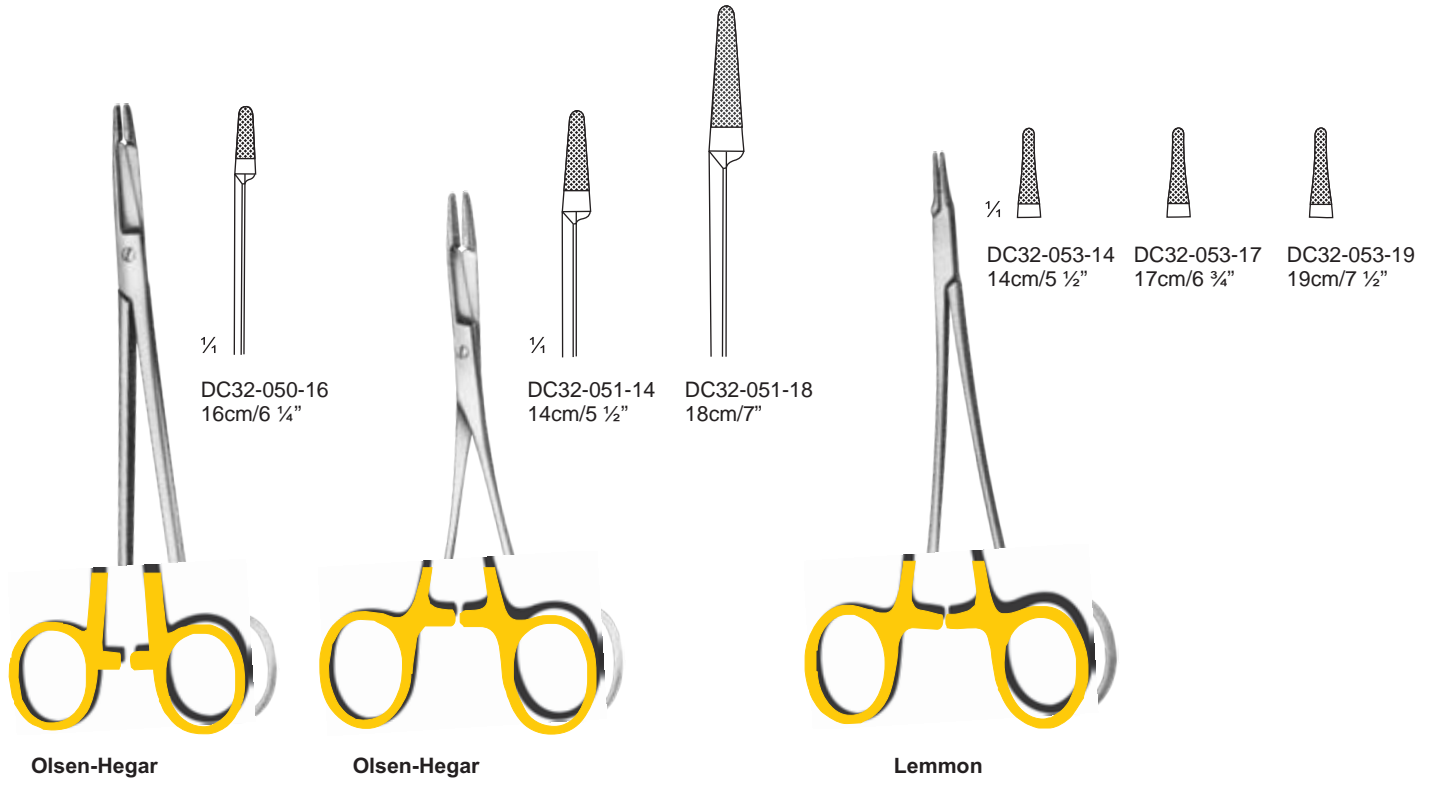

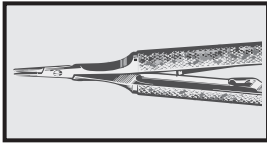

Needle Holders

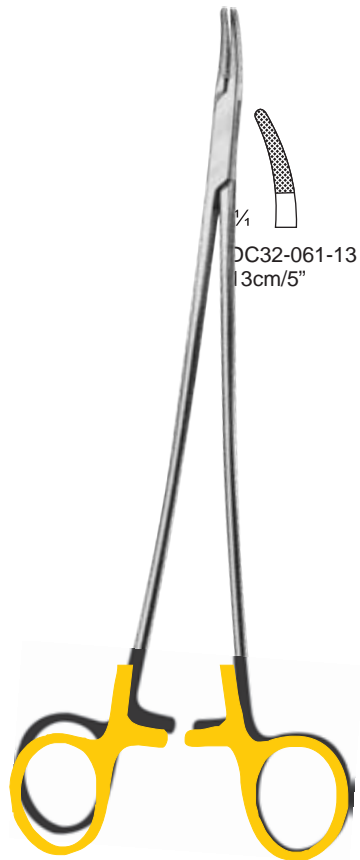

Crile-Wood

- DC32-061-13 13cm/5"^{1/4}
- DC32-061-15 15cm/6"
- DC32-061-18 18cm/7"
- DC32-061-20 20cm/8"
- DC32-061-23 23cm/9"



Mayo-Hegar

- DC32-063-14 14cm/5 1/2"
- DC32-063-16 16cm/6 1/4"
- DC32-063-18 18cm/7"
- DC32-063-20 20cm/8"
- DC32-063-23 23cm/9"
- DC32-063-26 26cm/10 1/4"
- DC32-063-30 30cm/12"

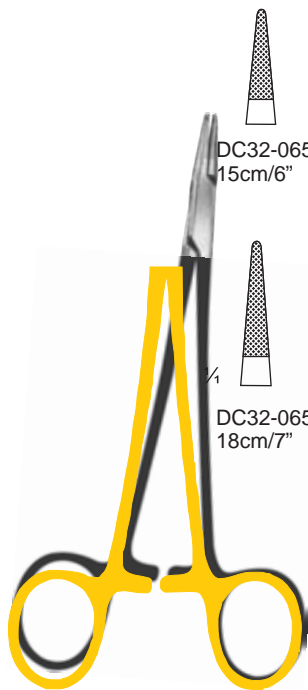

Crile Wood

- DC32-065-15 15cm/6"
- DC32-065-18 18cm/7"^{1/4}

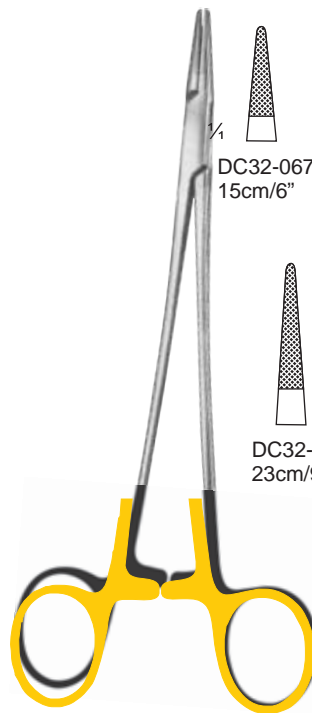





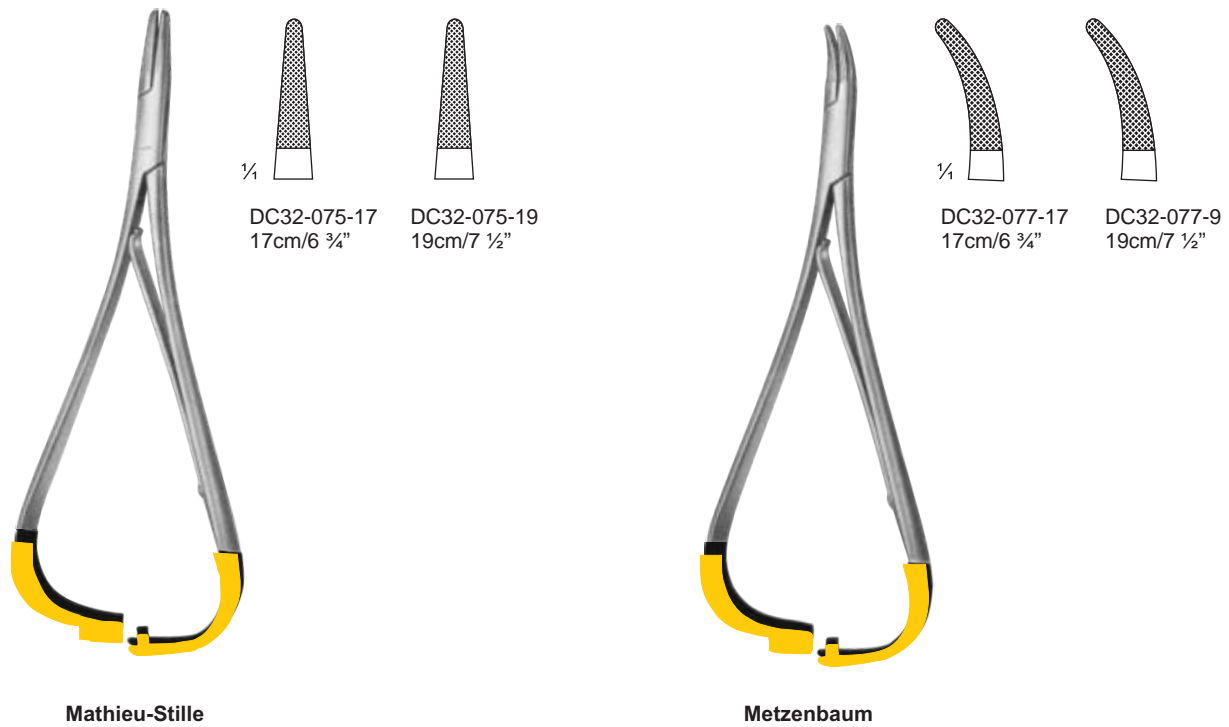
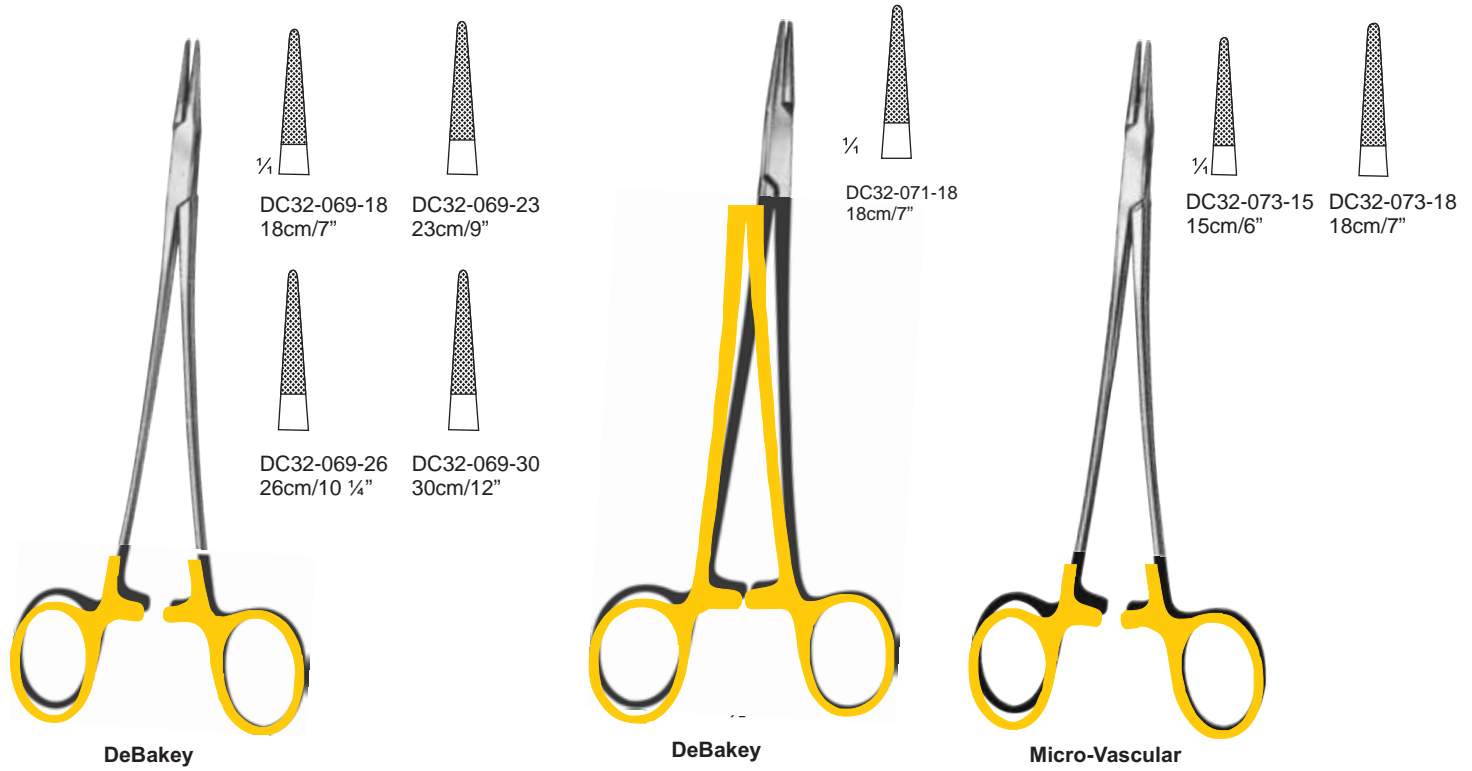
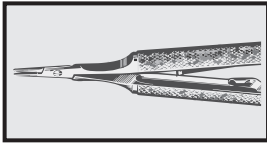

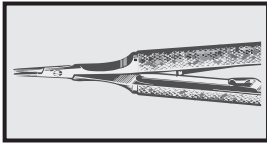
Crile-Wood (Newman)

- DC32-067-15 15cm/6"^{1/4}
- DC32-067-18 18cm/7"
- DC32-067-20 20cm/8"
- DC32-067-23 23cm/9"
- DC32-067-26 26cm/10 1/4"

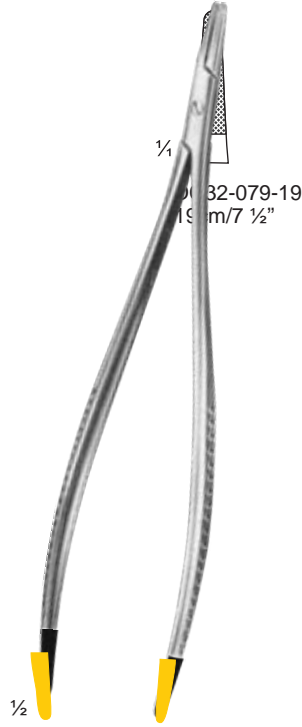



Needle Holders

 <p>DC32-079-19 19cm/7 1/2"</p> <p>1/4</p> <p>1/2</p>	 <p>DC32-081-14 14cm/5 1/2"</p> <p>DC32-081-17 17cm/6 3/4"</p> <p>DC32-081-20 20cm/8"</p> <p>1/4</p>	 <p>DC32-083-20 20cm/8"</p> <p>DC32-083-24 24cm/9 1/2"</p> <p>1/4</p>
 <p>DC32-085-14 14cm/5 1/2"</p> <p>DC32-085-17 17cm/6 3/4"</p> <p>DC32-085-20 20cm/8"</p>	 <p>DC32-087-20 20cm/8"</p> <p>DC32-087-23 23cm/9"</p> <p>1/4</p>	 <p>DC32-091-16 16cm/6 1/4"</p> <p>DC32-091-16 16cm/6 1/4"</p> <p>DC32-091-20 20cm/8"</p> <p>1/4</p>
<p>Mathieu</p>	<p>Zweifel</p>	<p>Langenbeck</p>

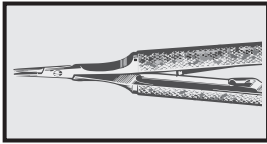

Needle Holders

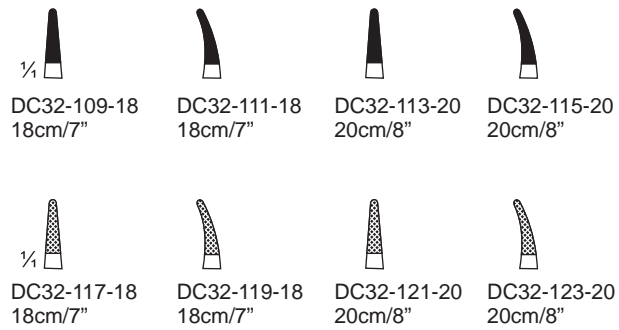
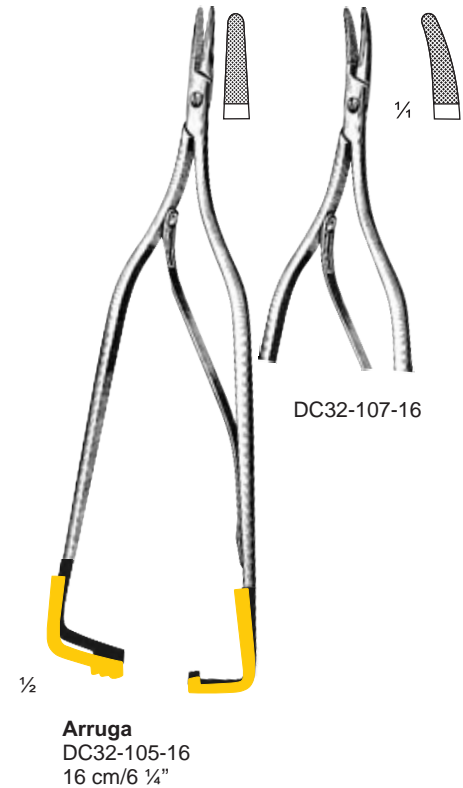
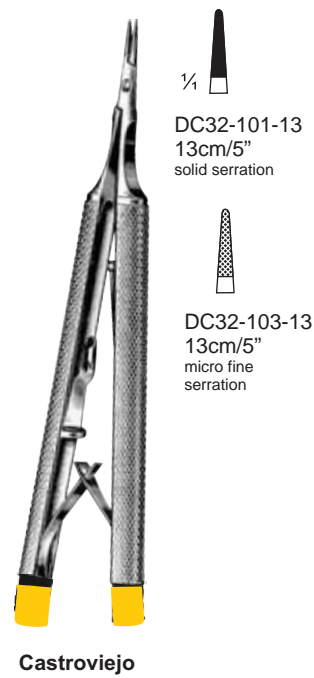
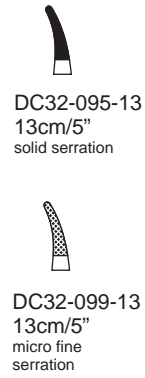
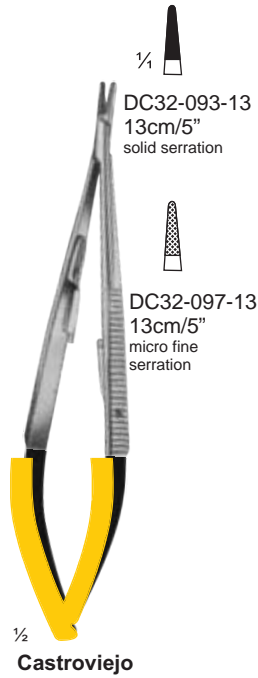



Lichtwitz
1.75 mm ø
DC32-125-17



Lichtwitz
2 mm ø
DC32-127-22



Pierce
DC32-129-3 mmø
DC32-129-4 mmø
DC32-129-5 mmø



Krause
5.5 mm ø
DC32-131-55

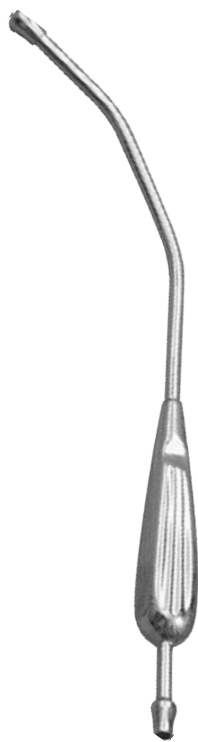

Yankauer
DC32-132-T



0
DC32-133-10



1
DC32-133-11



2
DC32-133-12



3
DC32-133-13

DC32-133-15

DC32-133-02



Yankauer
DC32-133-01



Schimmelbusch
DC32-135-01

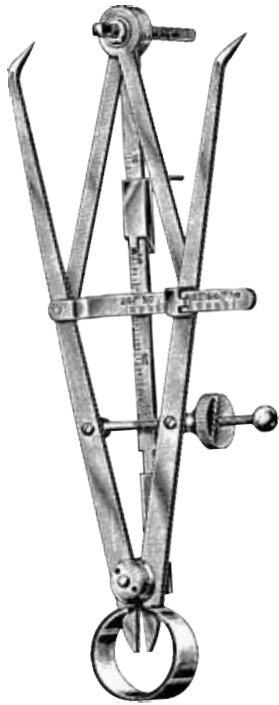
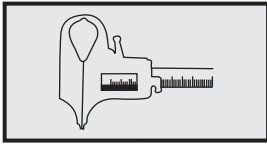

Korkhaus
DC32-137-01



18.5 cm / 7¼"
DC32-139-18



12 cm / 4¾"
DC32-141-12



DC32-143-01



Measuring range 0-15 mm
DC32-145-15



Measuring range 0-10 mm
DC32-147-10

DC32-137-01	Three dimensional Caliper
DC32-139-18	Bow space for orthodontic work
DC32-141-12	Dividing Compass
DC32-143-01	Bow Compass
DC32-145-15	Decimal spring Caliper
DC32-147-10	Decimal spring Caliper

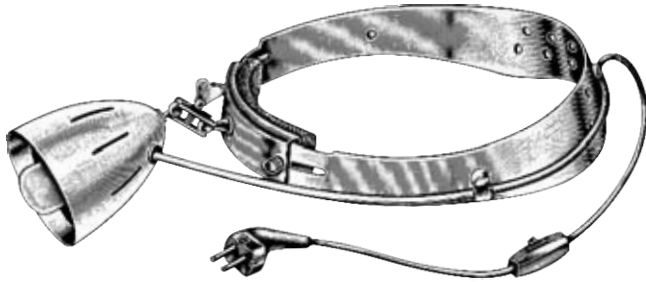
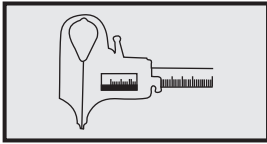

Orion
DC32-149-01

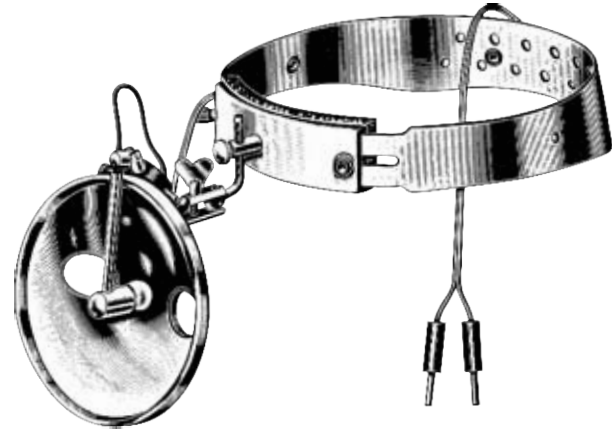

Clar
DC32-151-01

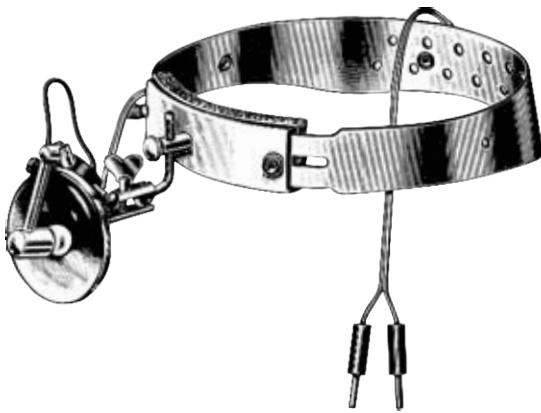

Clar-mini
DC32-153-01



11.5 cm / 4½"
DC32-155-11



11.5 cm / 4½"
DC32-157-11



Boley
DC32-159-01

DC32-149-01	DC32-151-01	Head Lamp
	DC32-153-01	Head Lamp
DC32-155-11	DC32-157-11	Tail Voice
	DC32-159-01	Caliper

9

ESPEJOS DENTALES Y JERINGAS

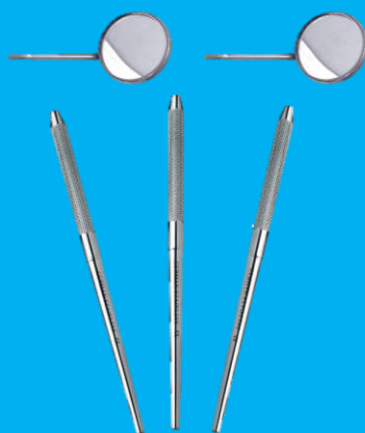

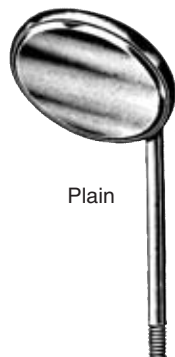
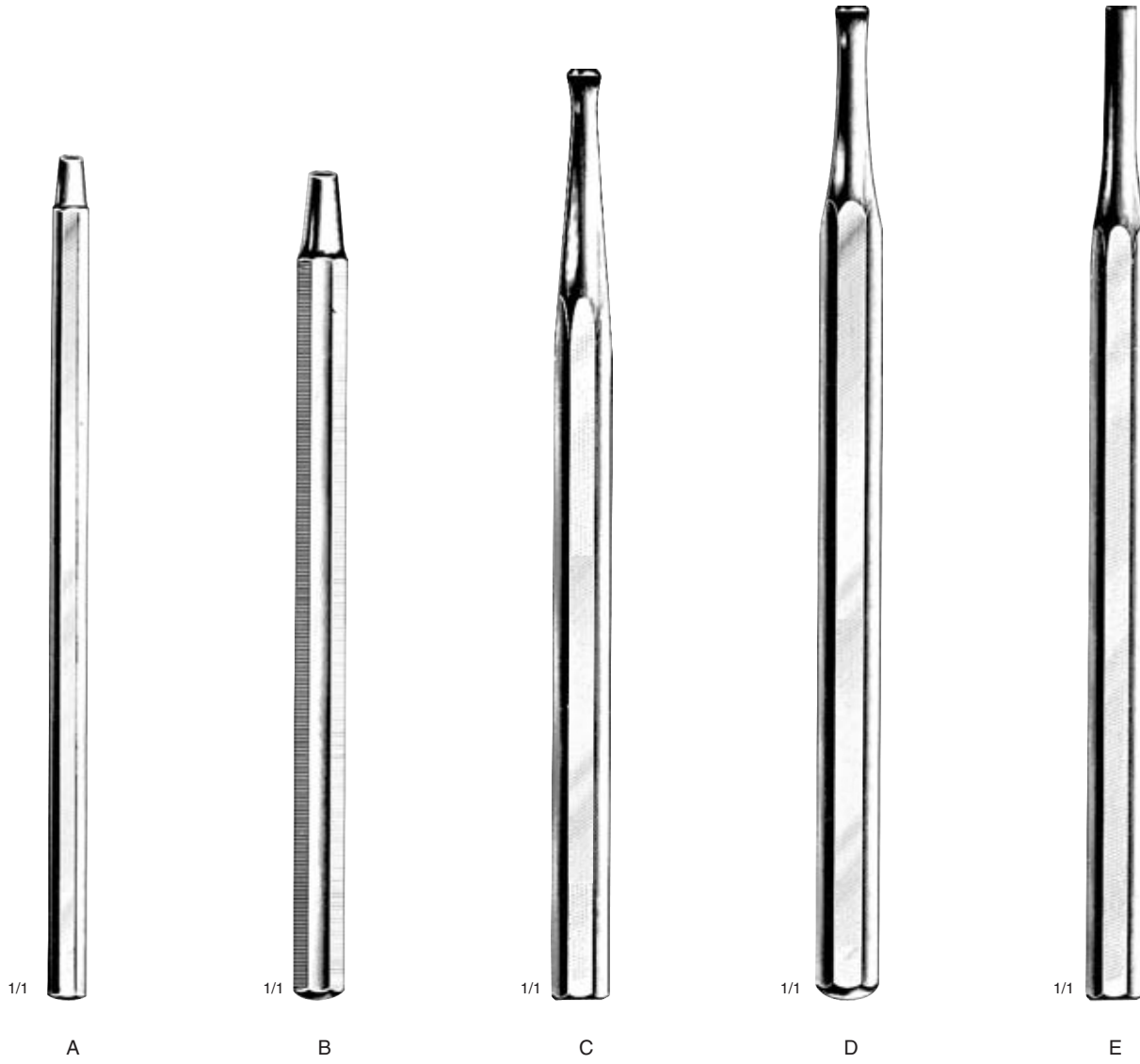
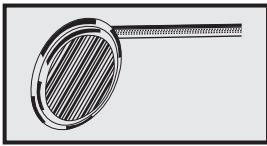

Plain

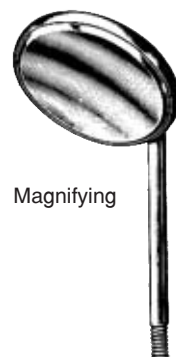

Magnifying

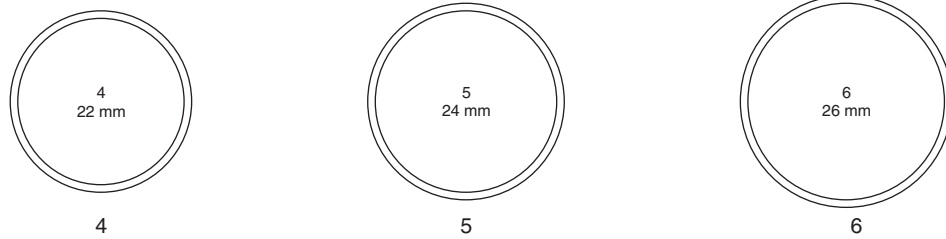
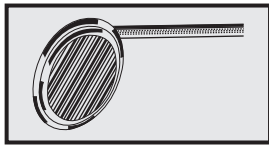

Plain

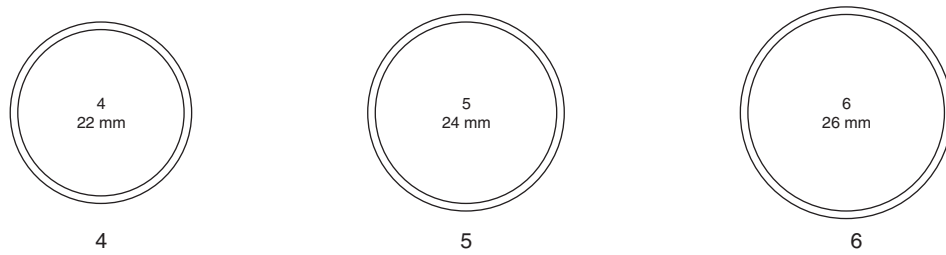

Magnifying

4 5 6
 ————— Plain —————

A	DC33-001-04	DC33-011-05	DC33-021-06
B	DC33-003-04	DC33-013-05	DC33-023-06
C	DC33-005-04	DC33-015-05	DC33-025-06
D	DC33-007-04	DC33-017-05	DC33-027-06
E	DC33-009-04	DC33-019-05	DC33-029-06

4 5 6
 ————— Magnifying —————

A	DC33-031-04	DC33-041-05	DC33-051-06
B	DC33-033-04	DC33-043-05	DC33-053-06
C	DC33-035-04	DC33-045-05	DC33-055-06
D	DC33-037-04	DC33-047-05	DC33-057-06
E	DC33-039-04	DC33-049-05	DC33-059-06

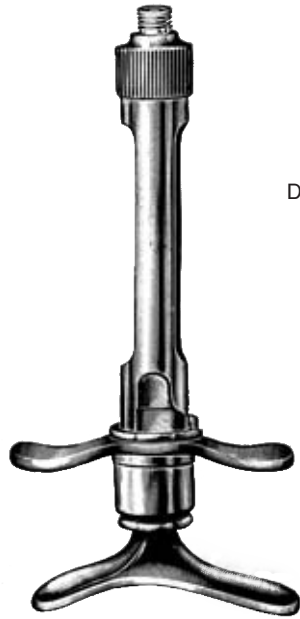
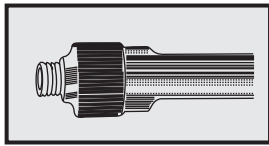

DC33-141-00
Cartridge Syringe



DC33-143-01



DC33-143-02



DC33-145-00

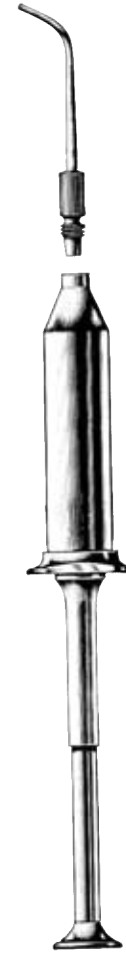

DC33-161-00



DC33-163-00



DC33-155-03
Cannulas



DC33-157-03
Cannulas



DC33-159-03
Cannulas

DC33-141-00	Cartridge Syringe
DC33-145-00	Chip Blower Syringe with cannula and bulb
DC33-155-03	DC33-159-03 Cannula for above
DC33-161-00	DC33-163-00 Metal Syringe

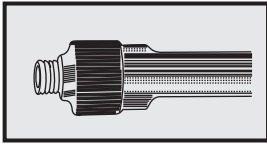

Dental Syringe



DC33-165-00



DC33-167-00



DC33-169-00



DC33-171-00



DC33-173-00



DC33-175-00

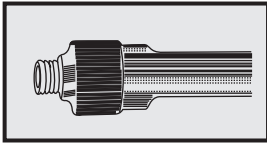

DC33-177-00



DC33-179-00



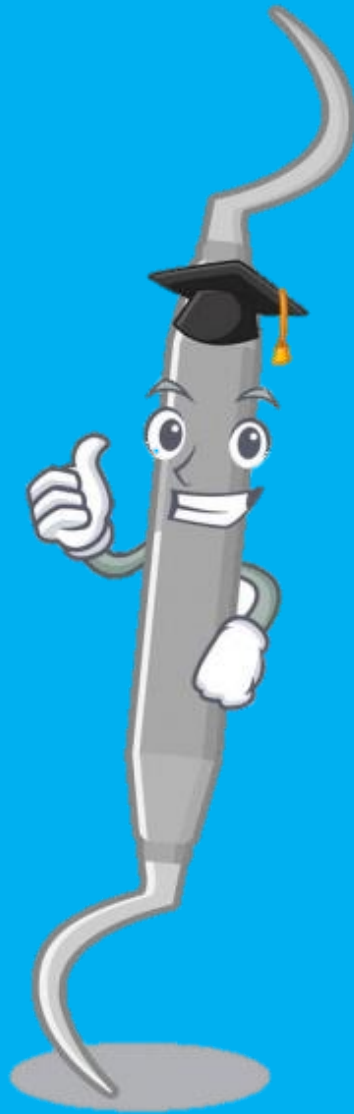

10

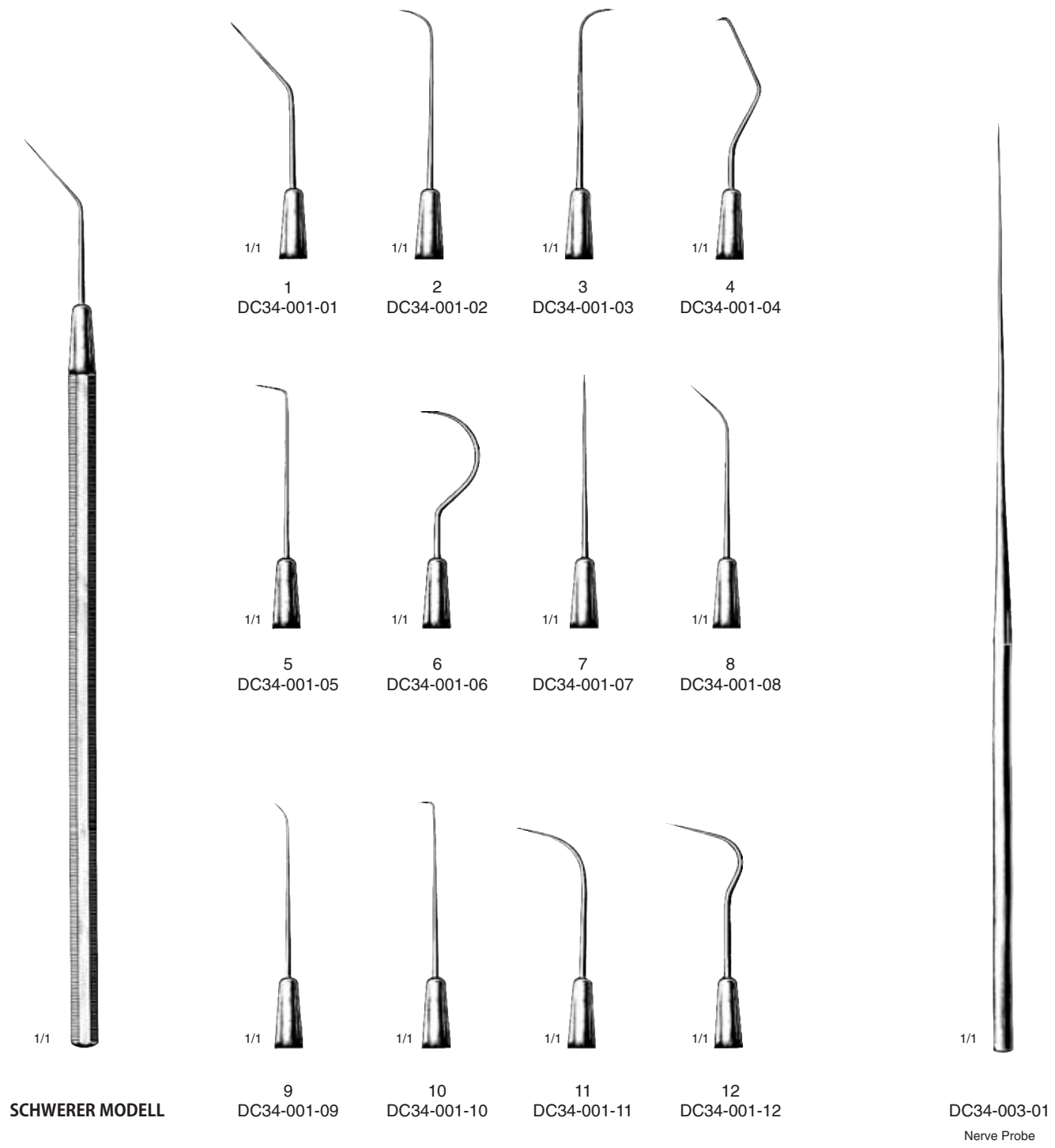
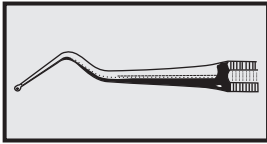

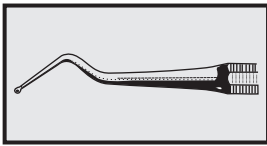

EXPLORADORES











				
	1/1	1/1	1/1	1/1
	1	2	3	4
A	DC34-005-01	DC34-005-02	DC34-005-03	DC34-005-04
B	DC34-007-01	DC34-007-02	DC34-007-03	DC34-007-04

				
	1/1	1/1	1/1	1/1
	5	5a	6	6a
A	DC34-005-05	DC34-005-55	DC34-005-06	DC34-005-66
B	DC34-007-05	DC34-007-55	DC34-007-06	DC34-007-66

				
	1/1	1/1	1/1	1/1
	7	8	8a	9
A	DC34-005-07	DC34-005-08	DC34-005-88	DC34-005-09
B	DC34-007-07	DC34-007-08	DC34-007-88	DC34-007-09

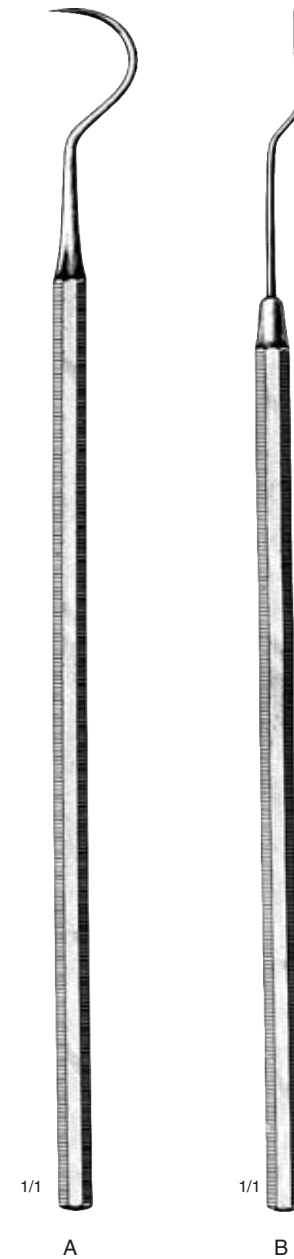

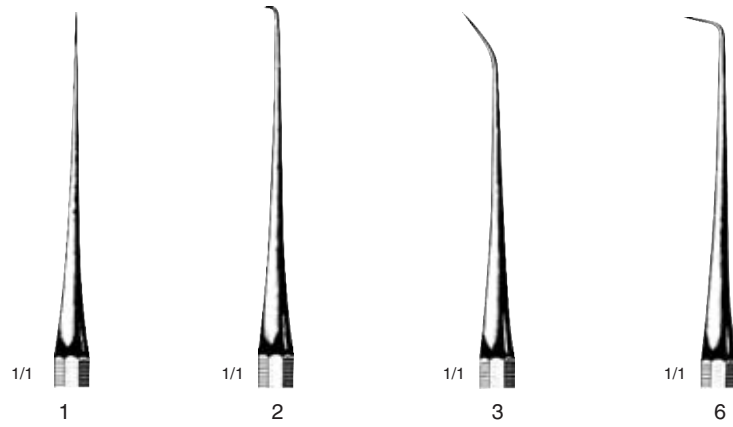
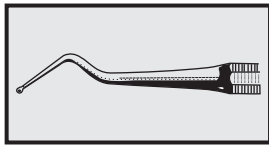

White

A	DC34-009-01	DC34-009-02	DC34-009-03	DC34-009-06
B	DC34-011-01	DC34-011-02	DC34-011-03	DC34-011-06
C	DC34-013-01	DC34-013-02	DC34-013-03	DC34-013-06

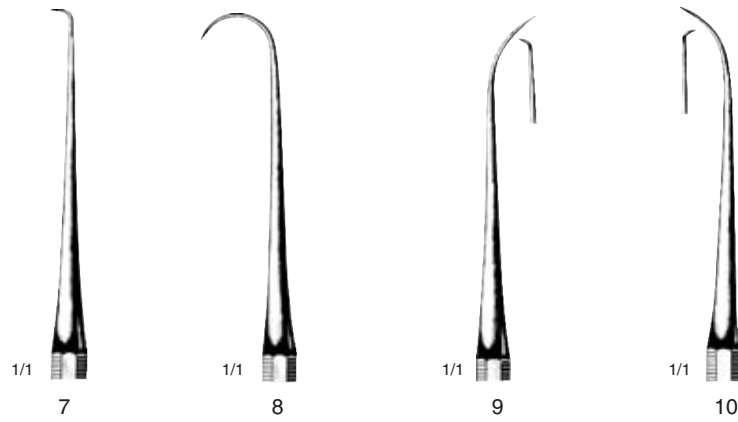

White

A	DC34-009-07	DC34-009-08	DC34-009-09	DC34-009-10
B	DC34-011-07	DC34-011-08	DC34-011-09	DC34-011-10
C	DC34-013-07	DC34-013-08	DC34-013-09	DC34-013-10

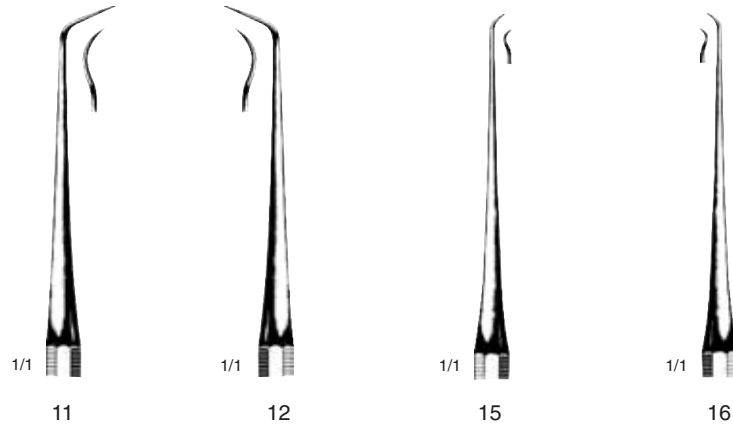

White

A	DC34-009-11	DC34-009-12	DC34-009-15	DC34-009-16
B	DC34-011-11	DC34-011-12	DC34-011-15	DC34-011-16
C	DC34-013-11	DC34-013-12	DC34-013-15	DC34-013-16

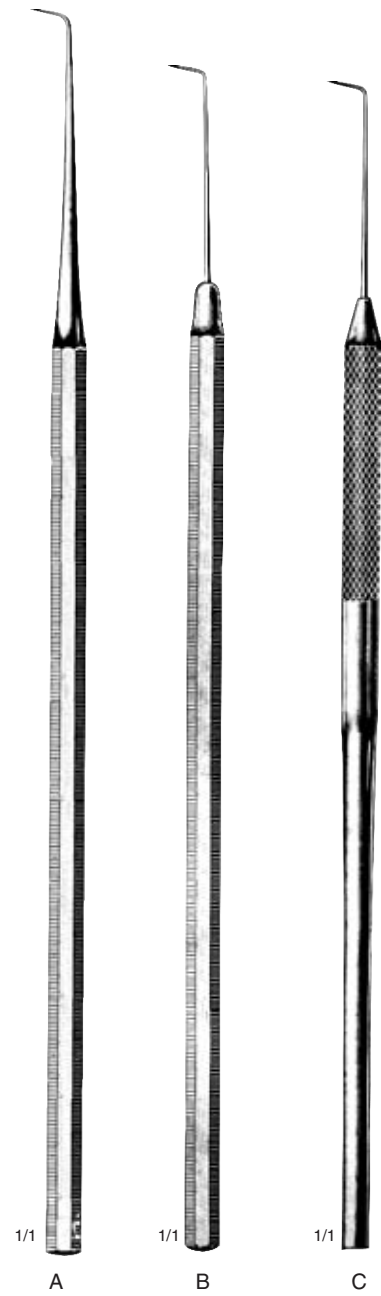

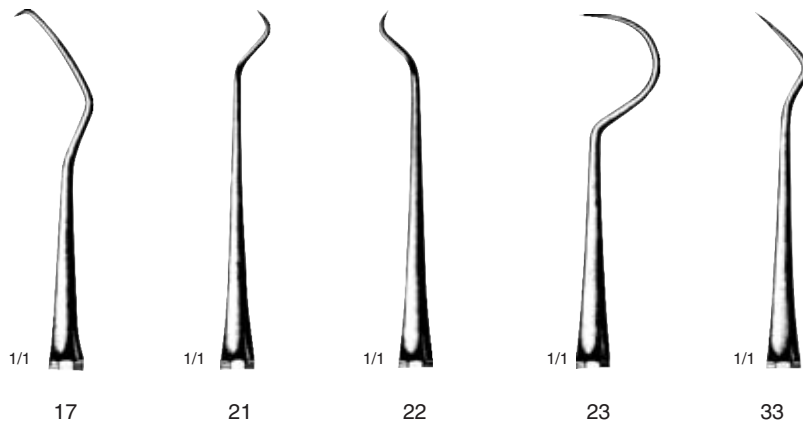
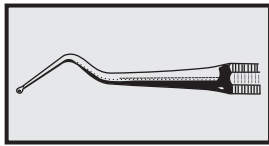

	17	21	22	23	33
	White				
A	DC34-015-17	DC34-015-21	DC34-015-22	DC34-015-23	DC34-015-33
B	DC34-016-17	DC34-016-21	DC34-016-22	DC34-016-23	DC34-016-33
C	DC34-017-17	DC34-017-21	DC34-017-22	DC34-017-23	DC34-017-33

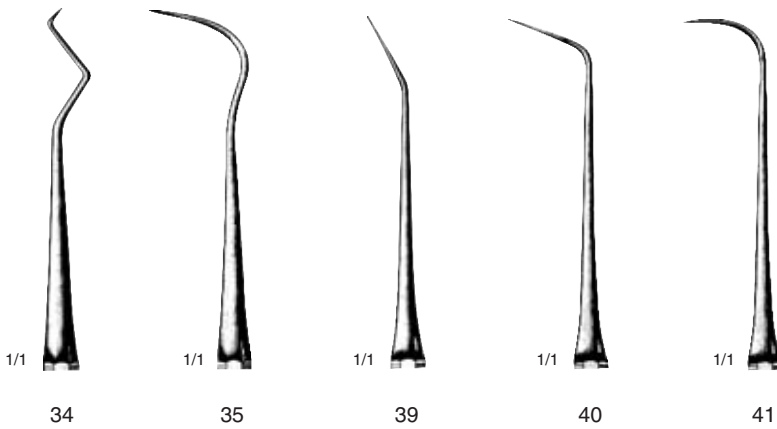

	34	35	39	40	41
	White				
A	DC34-015-34	DC34-015-35	DC34-015-39	DC34-015-40	DC34-015-41
B	DC34-016-34	DC34-016-35	DC34-016-39	DC34-016-40	DC34-016-41
C	DC34-017-34	DC34-017-35	DC34-017-39	DC34-017-40	DC34-017-41

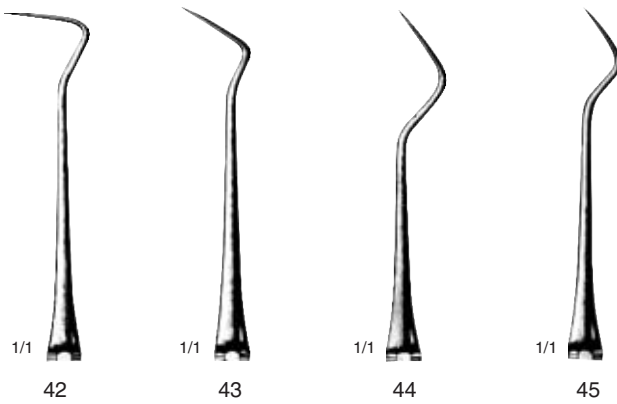

	42	43	44	45
	White			
A	DC34-015-42	DC34-015-43	DC34-015-44	DC34-015-45
B	DC34-016-42	DC34-016-43	DC34-016-44	DC34-016-45
C	DC34-017-42	DC34-017-43	DC34-017-44	DC34-017-45

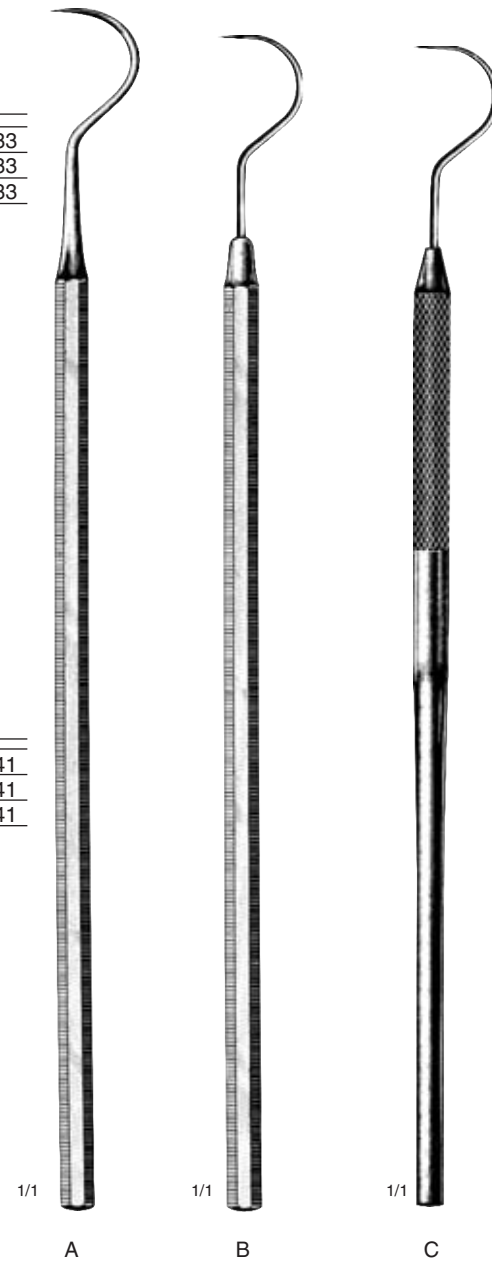

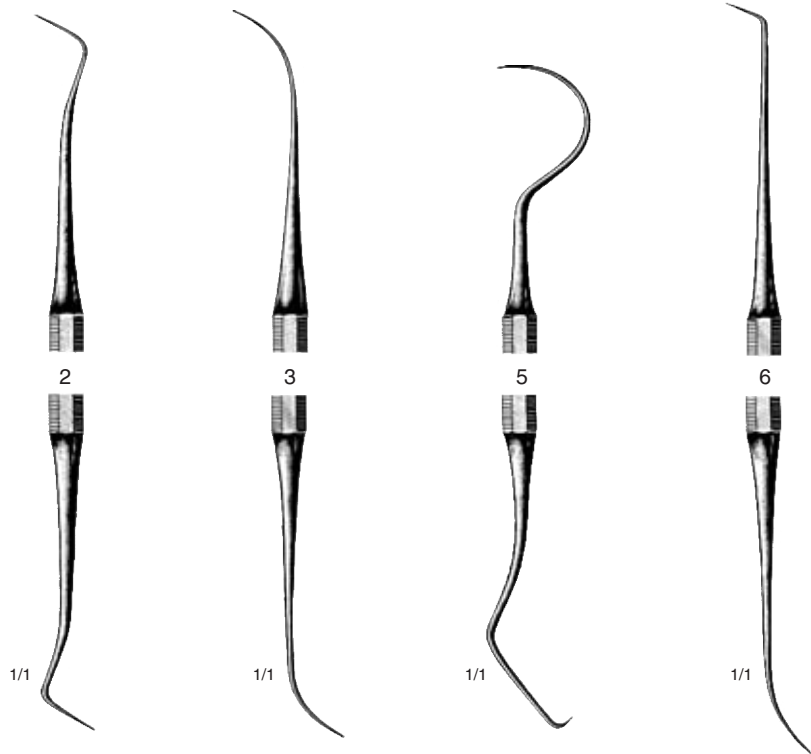
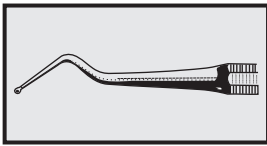

A	DC34-018-02	DC34-018-03	DC34-018-05	DC34-018-06
B	DC34-019-02	DC34-019-03	DC34-019-05	DC34-019-06
C	DC34-020-02	DC34-020-03	DC34-020-05	DC34-020-06

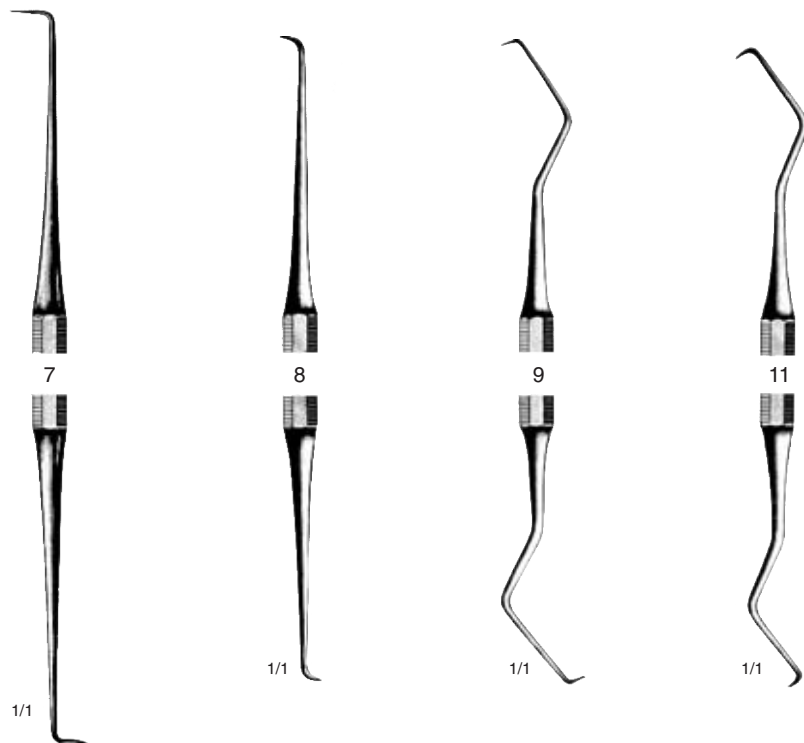

A	DC34-018-07	DC34-018-08	DC34-018-09	DC34-018-11
B	DC34-019-07	DC34-019-08	DC34-019-09	DC34-019-11
C	DC34-020-07	DC34-020-08	DC34-020-09	DC34-020-11

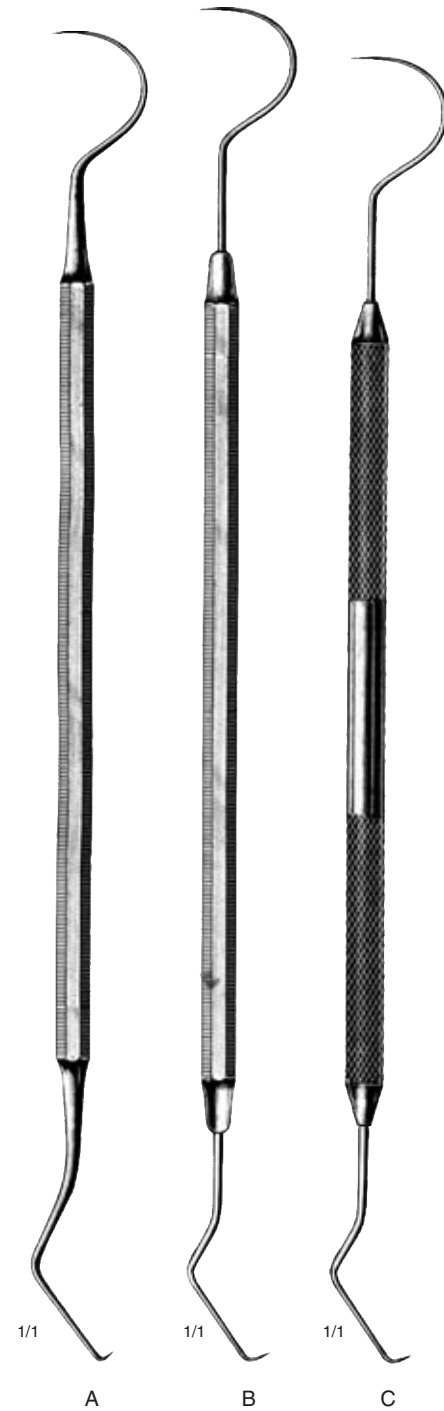

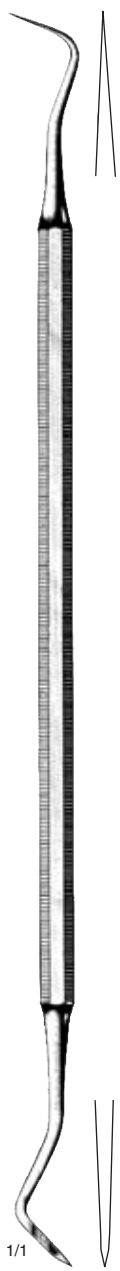
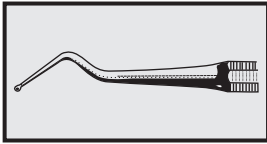

1/1
Lange
DC34-021-01

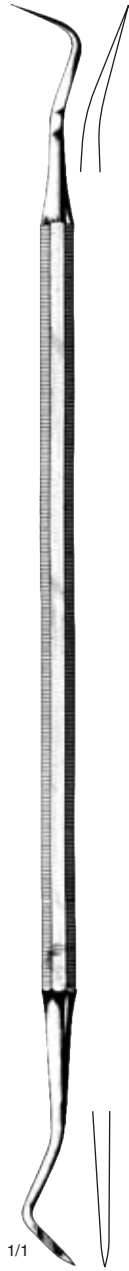

1/1
Lange
DC34-021-02



1/1
Weston
DC34-023-01



1/1
Weston
DC34-025-01



1/1
DC34-027-01



1/1
DC34-027-02



1/1
DC34-027-03

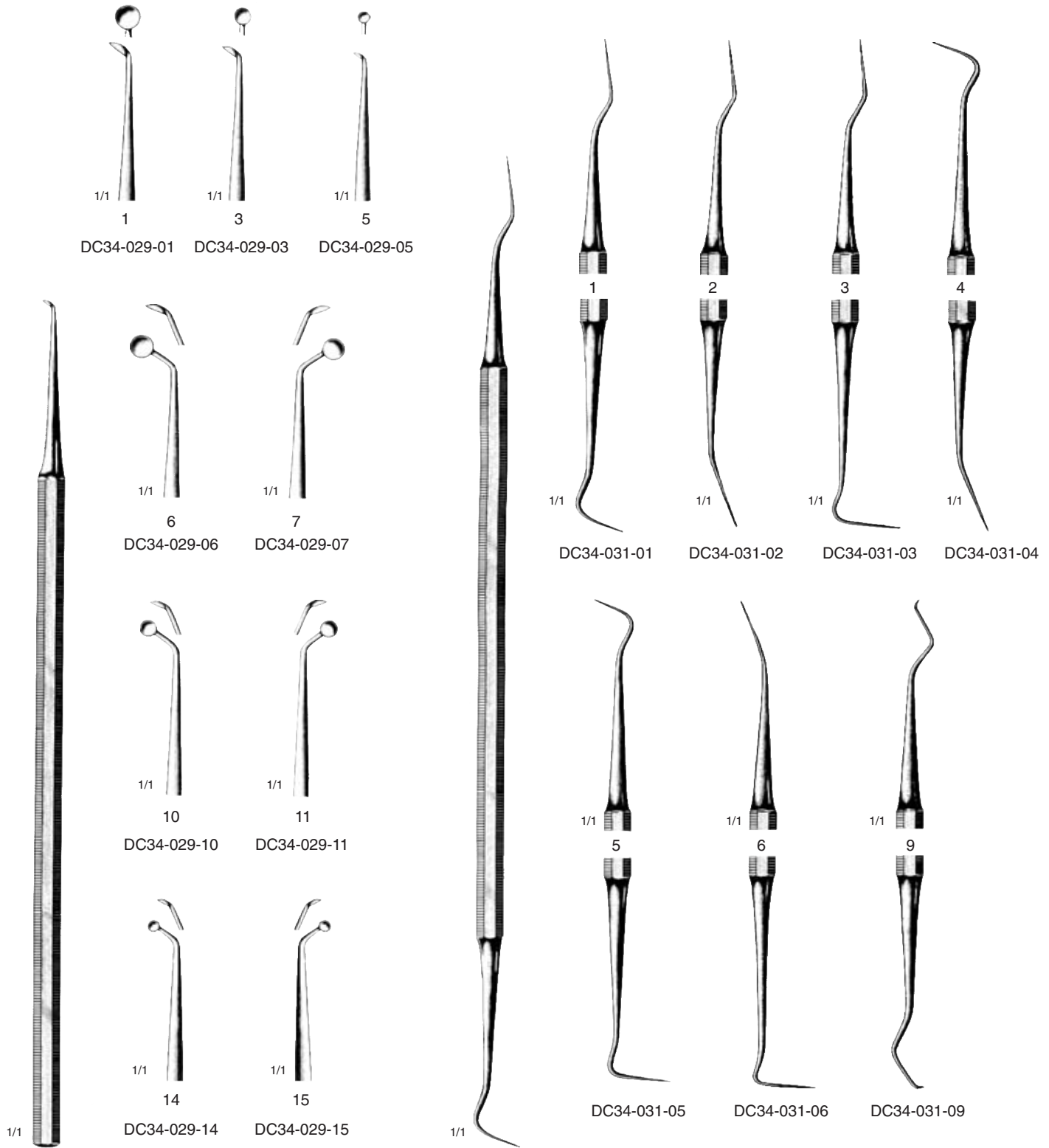
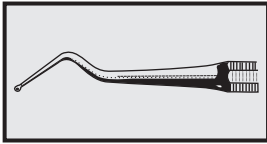

Witzel
Dentine Spoon

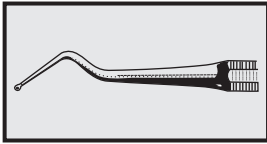

1/1						
	5	6	7	8	9	10
A	DC34-033-05	DC34-033-06	DC34-033-07	DC34-033-08	DC34-033-09	DC34-033-10
	5/6		7/8		9/10	
E	DC34-035-05		DC34-035-07		DC34-035-09	

1/1						
	11	12	13	14	15	16
A	DC34-033-11	DC34-033-12	DC34-033-13	DC34-033-14	DC34-033-15	DC34-033-16
	11/12		13/14		15/16	
E	DC34-035-11		DC34-035-13		DC34-035-15	

1/1						
	17	18	19	20	21	22
A	DC34-033-17	DC34-033-18	DC34-033-19	DC34-033-20	DC34-033-21	DC34-033-22
	17/18		19/20		21/22	
E	DC34-035-17		DC34-035-19		DC34-035-21	

Darby-Perry

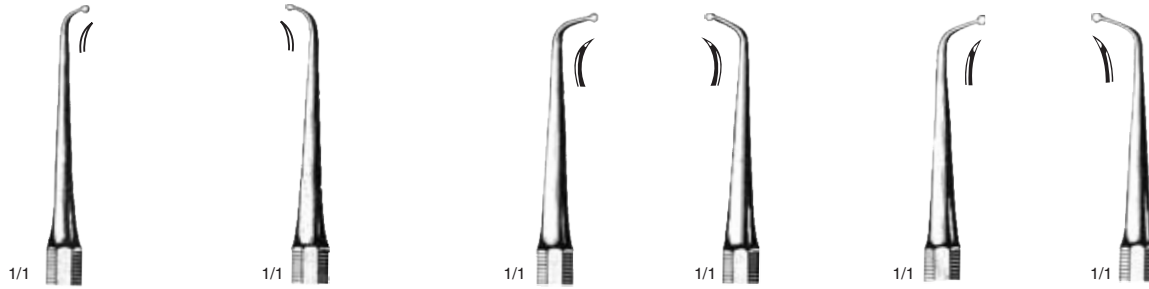
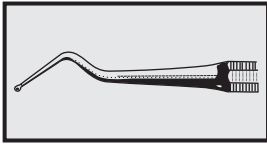

	3	4	7	8	9	10
A	DC34-037-03	DC34-037-04	DC34-037-07	DC34-037-08	DC34-037-09	DC34-037-10
	3/4		7/8		9/8	
E	DC34-039-03		DC34-039-07		DC34-039-09	

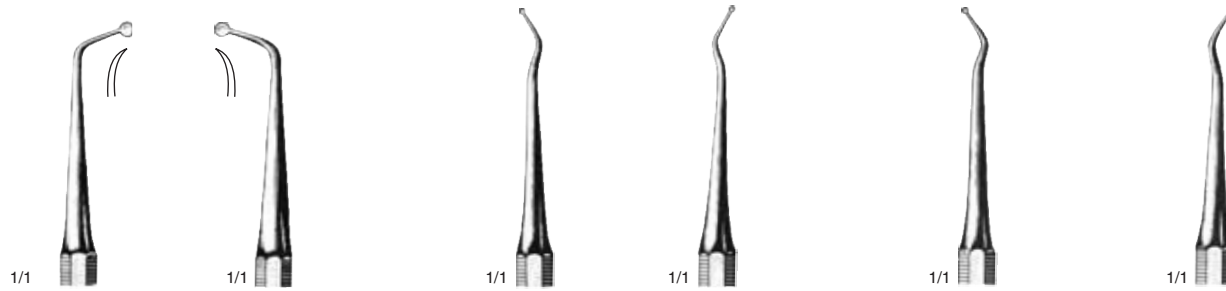



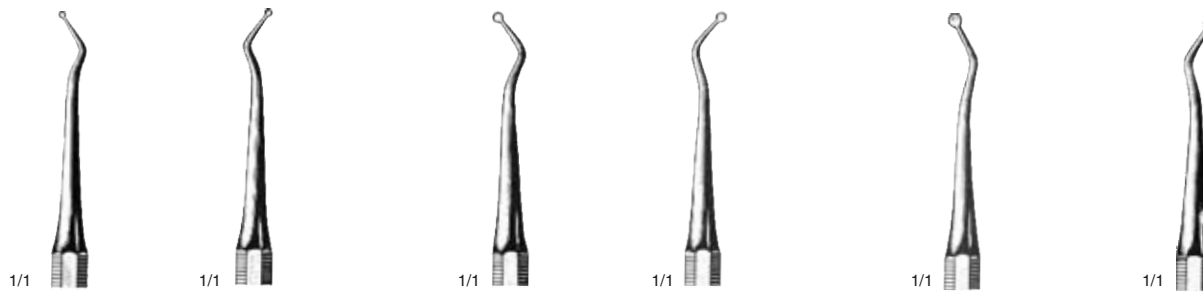

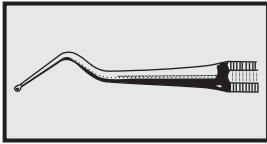

	11	12	13	14	15	16
A	DC34-037-11	DC34-037-12	DC34-037-13	DC34-037-14	DC34-037-15	DC34-037-16
	11/12		13/14		15/16	
E	DC34-039-11		DC34-039-13		DC34-039-15	



















	17	18	19	20	21	22
A	DC34-037-17	DC34-037-18	DC34-037-19	DC34-037-20	DC34-037-21	DC34-037-22
	17/18		19/20		21/22	
E	DC34-039-17		DC34-039-19		DC34-039-21	



Excavators

						
	1/1	1/1	1/1	1/1	1/1	1/1
	23	24	25	26	27	28
A	DC34-037-23	DC34-037-24	DC34-037-25	DC34-037-26	DC34-037-21	DC34-037-28
	23/24		25/26		27/28	
E	DC34-039-23		DC34-039-25		DC34-039-27	

								
	1/1	1/1	1/1	1/1	1/1	1/1	1/1	1/1
	29	30	31	32	33	34	35	36
A	DC34-037-29	DC34-037-30	DC34-037-31	DC34-037-32	DC34-037-33	DC34-037-34	DC34-037-35	DC34-037-36
	29/30		31/32		33/34		35/36	
E	DC34-039-29		DC34-039-31		DC34-039-33		DC34-039-35	

								
	1/1	1/1	1/1	1/1	1/1	1/1	1/1	1/1
	4	5	6	7	12	13	14	15
	Gillet	Gillet	Gillet	Gillet	Gillet	Gillet	Gillet	Gillet
A	DC34-041-04	DC34-041-05	DC34-041-06	DC34-041-07	DC34-041-12	DC34-041-13	DC34-041-14	DC34-041-15
	4/5		6/7		12/13		14/15	
E	DC34-043-04		DC34-043-06		DC34-043-12		DC34-043-14	

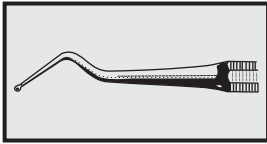

1/1

A

1/1

E

	171	172	173	174
A	DC34-045-71	DC34-045-72	DC34-045-73	DC34-045-74
	171/172		173/174	
E	DC34-047-71		DC34-047-73	

1/1

	175	176
A	DC34-045-75	DC34-045-76
	175/176	
E	DC34-047-75	

1/1

	177	178	179	180
A	DC34-045-77	DC34-045-78	DC34-045-79	DC34-045-80
	177/178		179/180	
E	DC34-047-77		DC34-047-79	

1/1

Friedman
DC34-049-01

1/1

Friedman
DC34-051-01

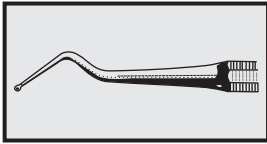

Excavators



1/1



5



1/1

DC34-053-05



14



1/1

DC34-053-14



17



1/1

DC34-053-17

White



18



1/1

DC34-053-18



19



1/1

DC34-053-19



20



1/1

DC34-053-20

White

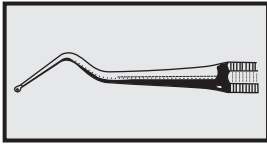

Excavators

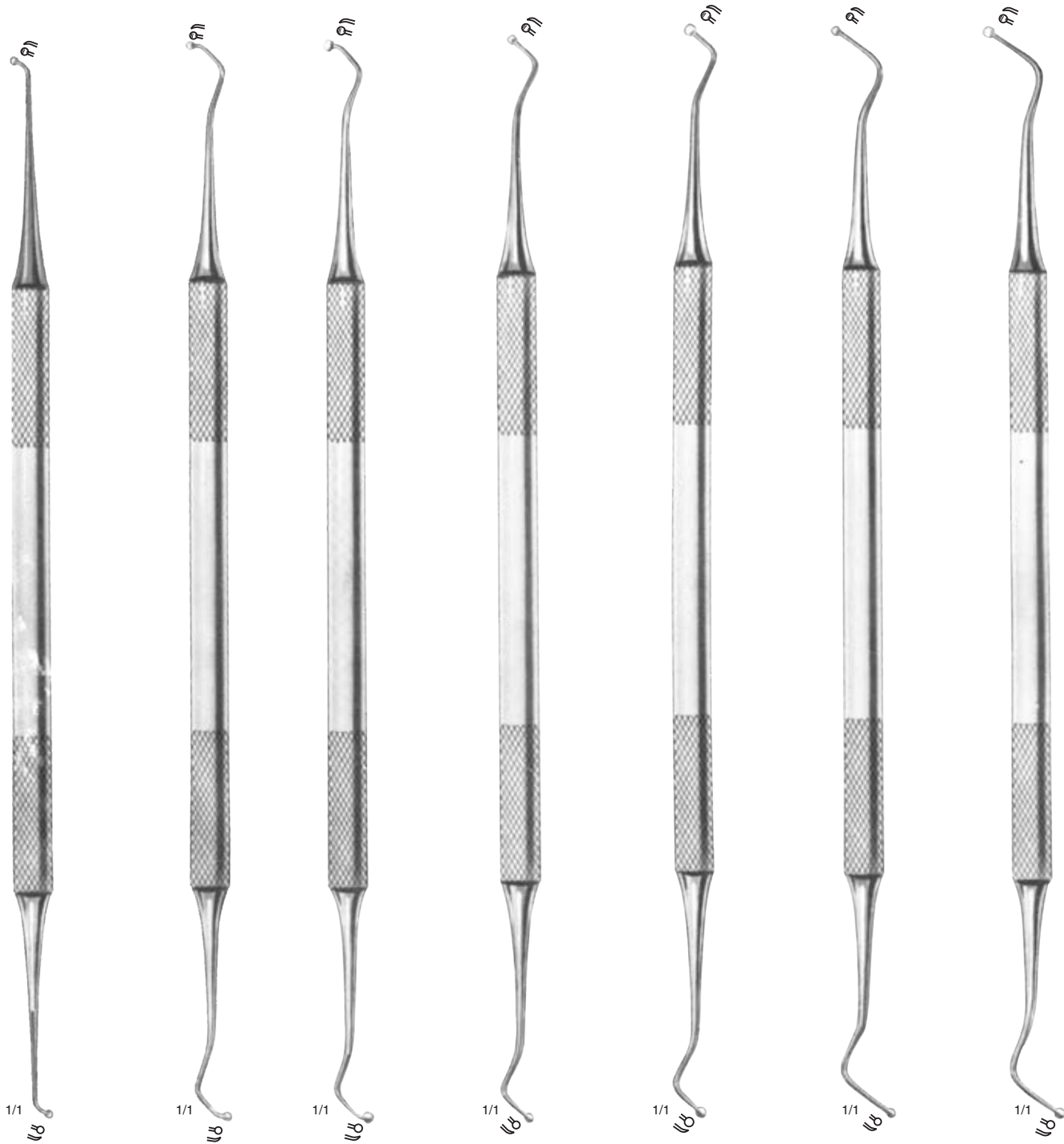

DC34-055-05

DC34-055-13

DC34-055-14

DC34-055-17

DC34-055-18

DC34-055-31

DC34-055-33

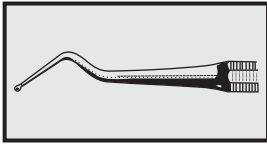

Cutting Instruments

1/1 Black							
	3	9	14	17	20	28	32
	DC34-057-03	DC34-057-09	DC34-057-14	DC34-057-17	DC34-057-20	DC34-057-28	DC34-057-32
	A 10	10	12	6	12	8	12
	B 4	4	5	2	5	3	5
	C 6	12	18	18	23	6	12
	38	41	51	52	53	54	57
	DC34-057-38	DC34-057-41	DC34-057-51	DC34-057-52	DC34-057-53	DC34-057-54	DC34-057-57
	A 12	6	15	15	10	10	15
B 5	2	8	8	6	6	8	
C 18	18	12	12	12	12	6	
		L	R	L	R	L	
58	61	62	63	64	65	66	
DC34-057-58	DC34-057-61	DC34-057-62	DC34-057-63	DC34-057-64	DC34-057-65	DC34-057-66	
15	20	20	15	15	10	10	
A 8	9	9	8	8	6	6	
B 6	12	12	12	12	12	12	
C R	L	R	L	R	L	R	

A) Width of Blade in 1/10 mm
 B) Length of the blade in mm
 C) Angle of the blade to its handle

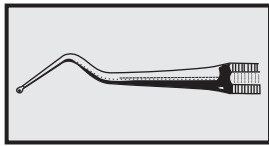

Cutting Instruments

1/1							
	69	70	73	74	75	76	77
	DC34-059-69	DC34-059-70	DC34-059-73	DC34-059-74	DC34-059-75	DC34-059-76	DC34-059-77
	A 15	15	20	20	20	20	15
	B 8	8	9	9	9	9	8
	C 23	23	12	12	12	12	12
	L	R	L	R	L	R	L
	78	81	82	83	84	85	
	DC34-059-78	DC34-059-81	DC34-059-82	DC34-059-83	DC34-059-84	DC34-059-85	
A 15	20	15	10	20	15		
B 8	9	8	6				
C 12	6	6	6				
R							
1/1							
	86	87	90	93	95	98	99
	DC34-059-86	DC34-059-87	DC34-059-90	DC34-059-93	DC34-059-95	DC34-059-98	DC34-059-99
	A 10	5	15	15	12	8	12
	B 3	3	1½		8	6	8
	C 28	28	12		12	23	12

Black

A) Width of Blade in 1/10 mm
 B) Length of the blade in mm
 C) Angle of the blade to its handle

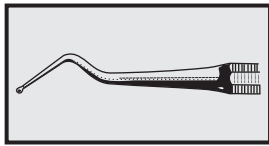

Cutting Instruments, double ended



1/1

49	51	53	57	61	63
DC34-061-49	DC34-061-51	DC34-061-53	DC34-061-57	DC34-061-61	DC34-061-63
20	15	10	15	20	15
9	8	6	8	9	8
12	12	12	6	12	12
L	L	L	L	L	L

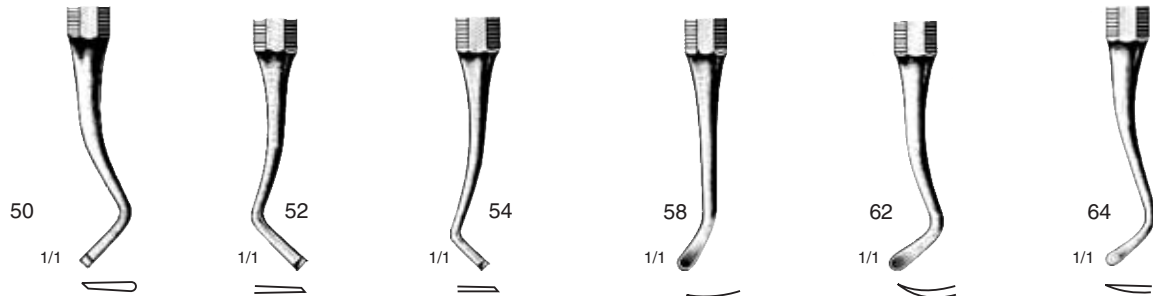
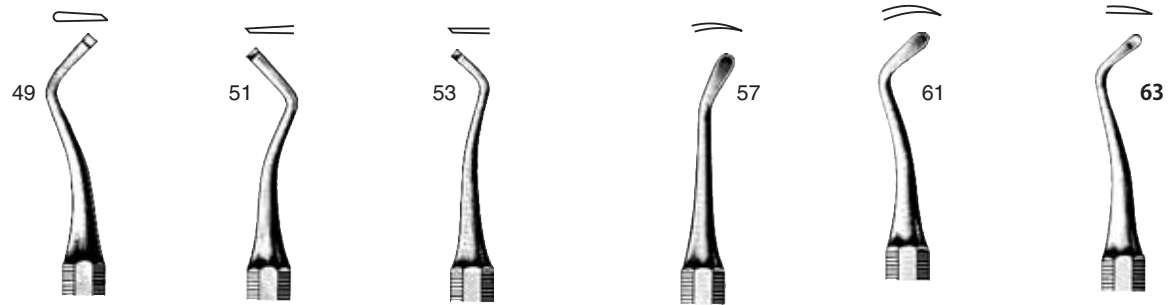

50	52	54	58	62	64
DC34-061-50	DC34-061-52	DC34-061-54	DC34-061-58	DC34-061-62	DC34-061-64
20	15	10	15	20	15
9	8	6	8	9	8
12	12	12	6	12	12
L	L	L	L	L	L

A) Width of Blade in 1/10 mm
 B) Length of the blade in mm
 C) Angle of the blade to its handle

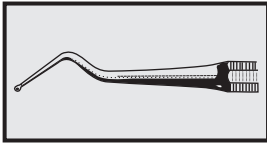

Cutting Instruments, double ended

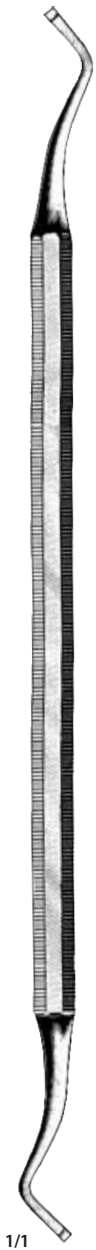

1/1

65	69	73	75	77	79
DC34-063-65	DC34-063-69	DC34-063-73	DC34-063-75	DC34-063-77	DC34-063-79
10	15	20	20	15	15
6	8	9	9	8	8
12	23	12	12	12	12
R	R	R	R	R	R

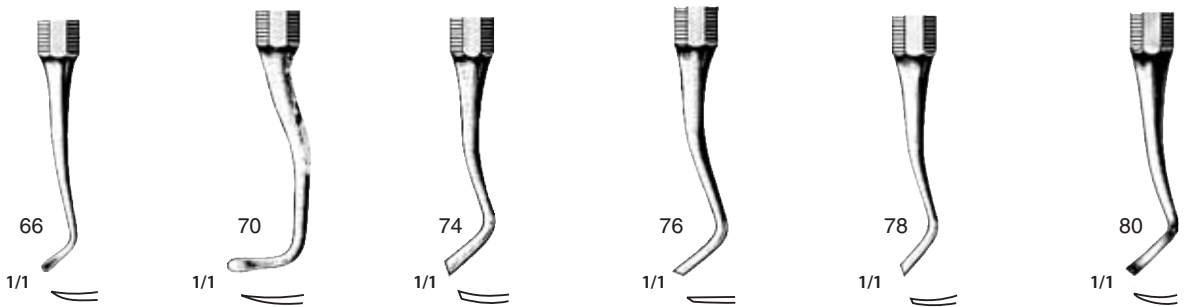
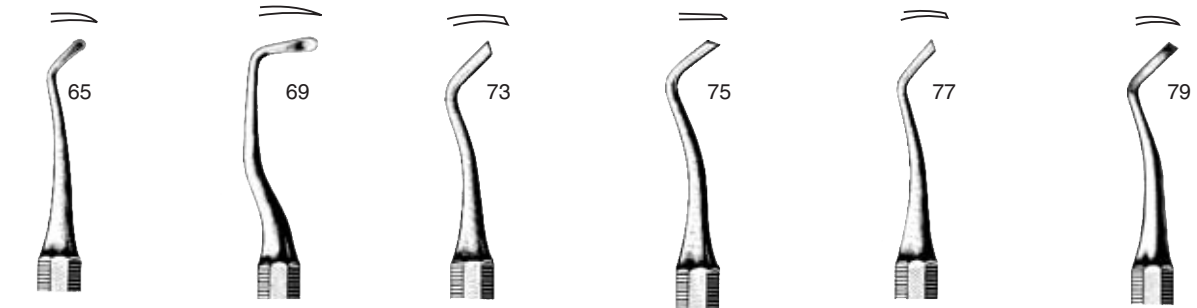

66	70	74	76	78	80
DC34-063-66	DC34-063-70	DC34-063-74	DC34-063-76	DC34-063-78	DC34-063-80
10	15	20	20	15	15
6	8	9	9	8	8
12	23	12	12	12	12
L	L	L	L	L	L

A) Width of Blade in 1/10 mm
 B) Length of the blade in mm
 C) Angle of the blade to its handle

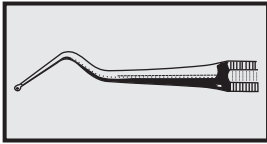

Nerve Instruments, Nerve Broach Holders

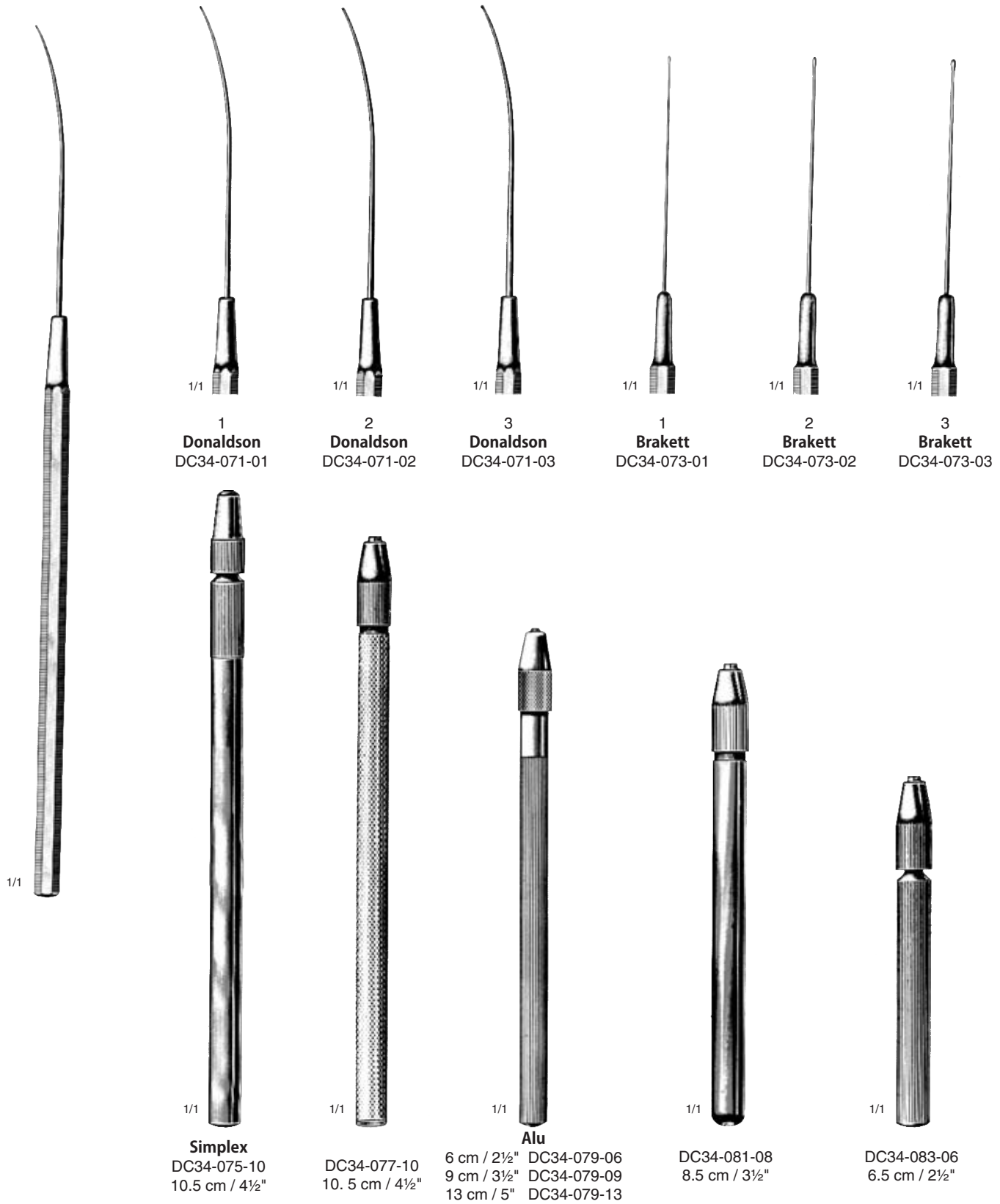

DC34-071-01	DC34-071-03	Nerve Canal Pluggers
DC34-073-01	DC34-073-03	Abscess and Fistula Probes

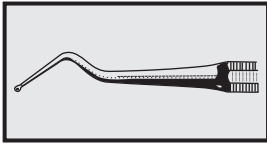

Gold Filling Instruments



Abbott
DC34-085-01



1/1 DC34-087-01 DC34-087-02 DC34-087-03 DC34-087-04

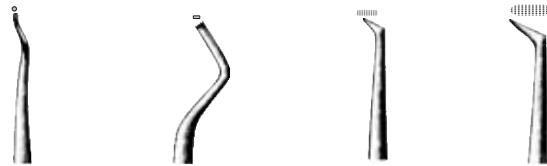

DC34-087-05 DC34-087-07 DC34-087-08 DC34-087-09



DC34-087-10 DC34-087-11 DC34-087-12



Marshall
DC34-089-01

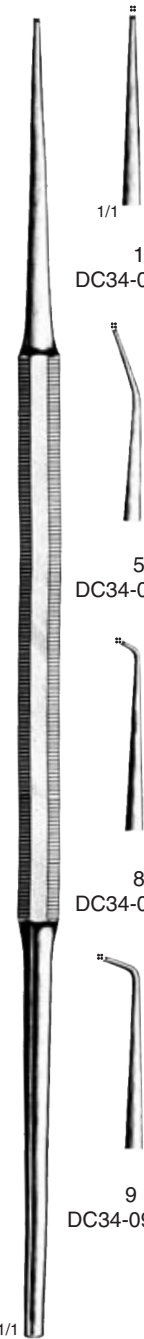

Gold Pluggers

1/1 1 DC34-091-01
5 DC34-091-05
8 DC34-091-08
9 DC34-091-09

DC34-085-01	Automatic mallet
DC34-089-01	Pellet Placer
DC34-091-01	DC34-091-09
	Gold pluggers

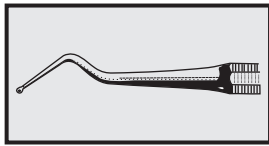

Finishing Instruments

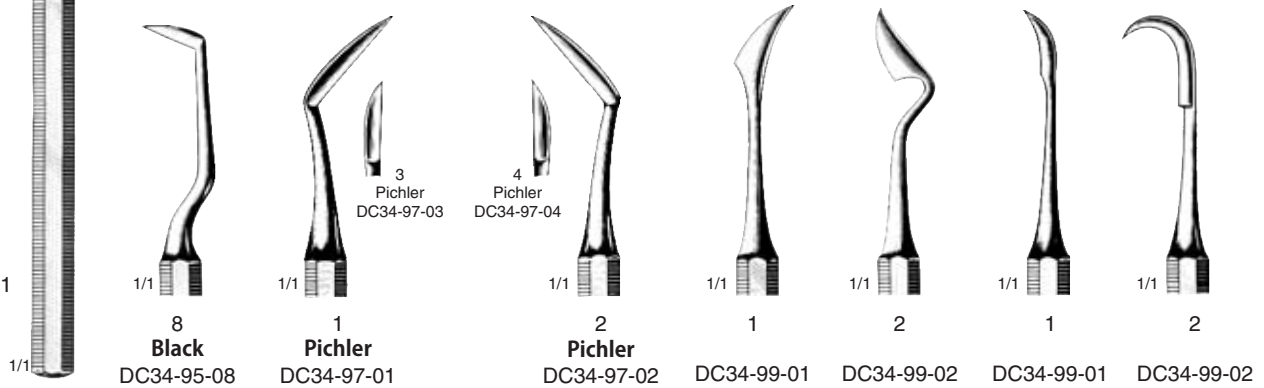
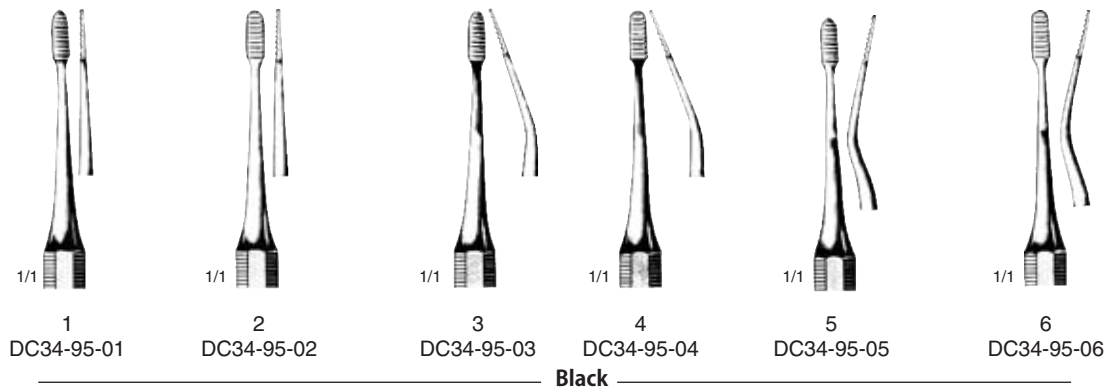
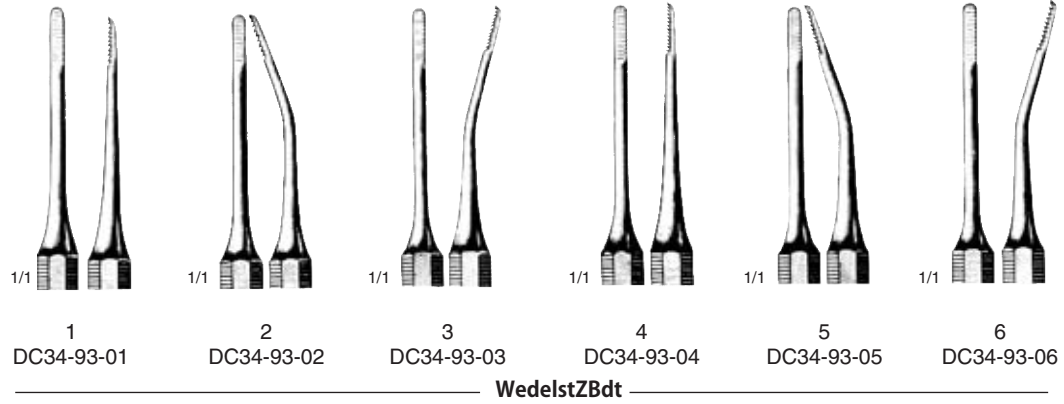

DC34-93-01	DC34-95-06	Finishing Files
DC34-95-08	DC34-99-02	Finishing Knives

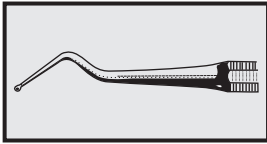

Instruments for Amalgam,
Gutta-Percha and Cement

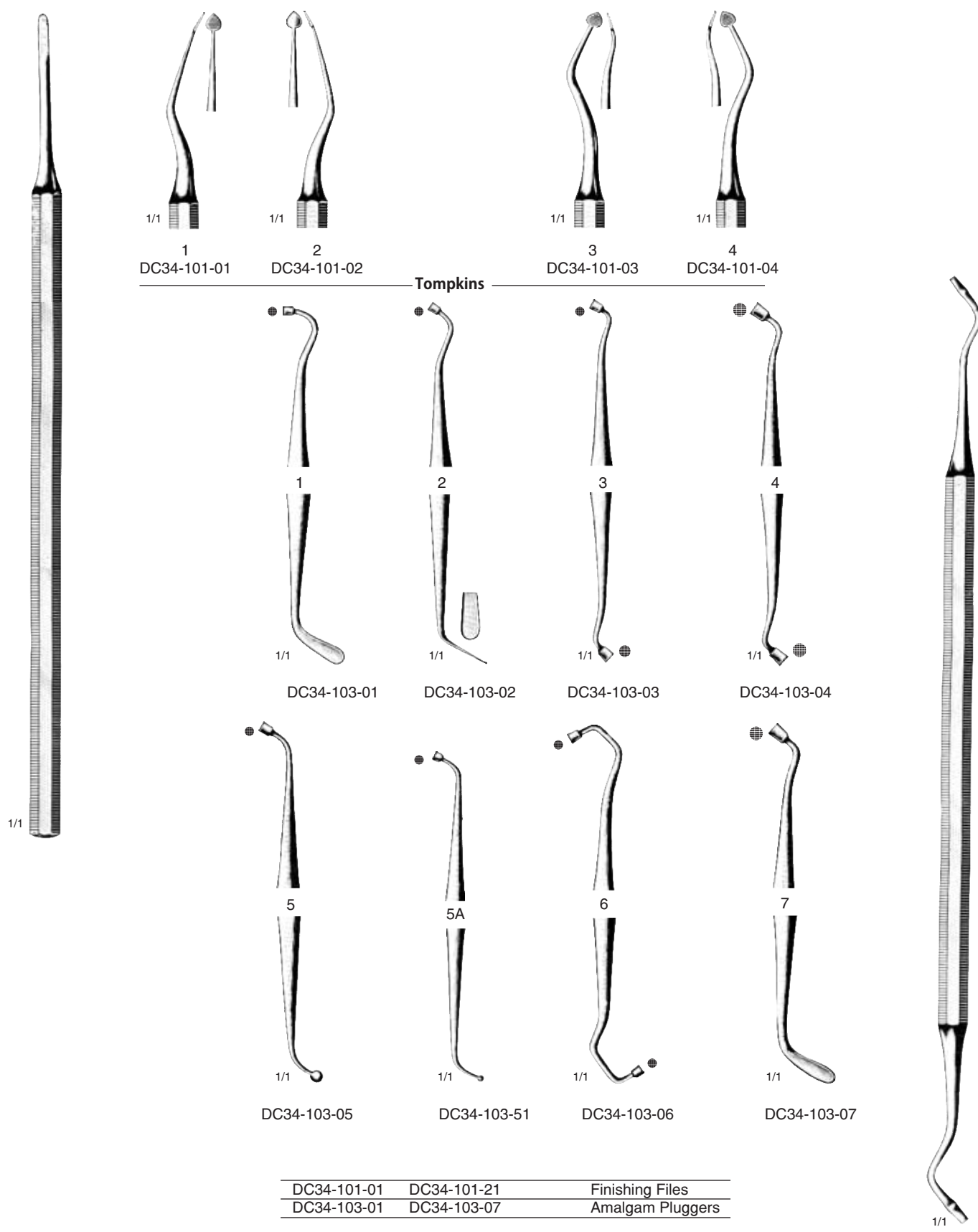

1/1
1
DC34-101-01

1/1
2
DC34-101-02

1/1
3
DC34-101-03

1/1
4
DC34-101-04

Tompkins

1/1
1
DC34-103-01

1/1
2
DC34-103-02

1/1
3
DC34-103-03

1/1
4
DC34-103-04

1/1
5
DC34-103-05

1/1
5A
DC34-103-51

1/1
6
DC34-103-06

1/1
7
DC34-103-07

DC34-101-01	DC34-101-21	Finishing Files
DC34-103-01	DC34-103-07	Amalgam Pluggers

1/1

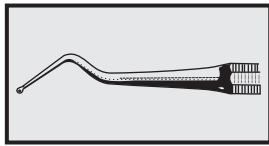

Instruments for Amalgam,
Gutta-Percha and Cement

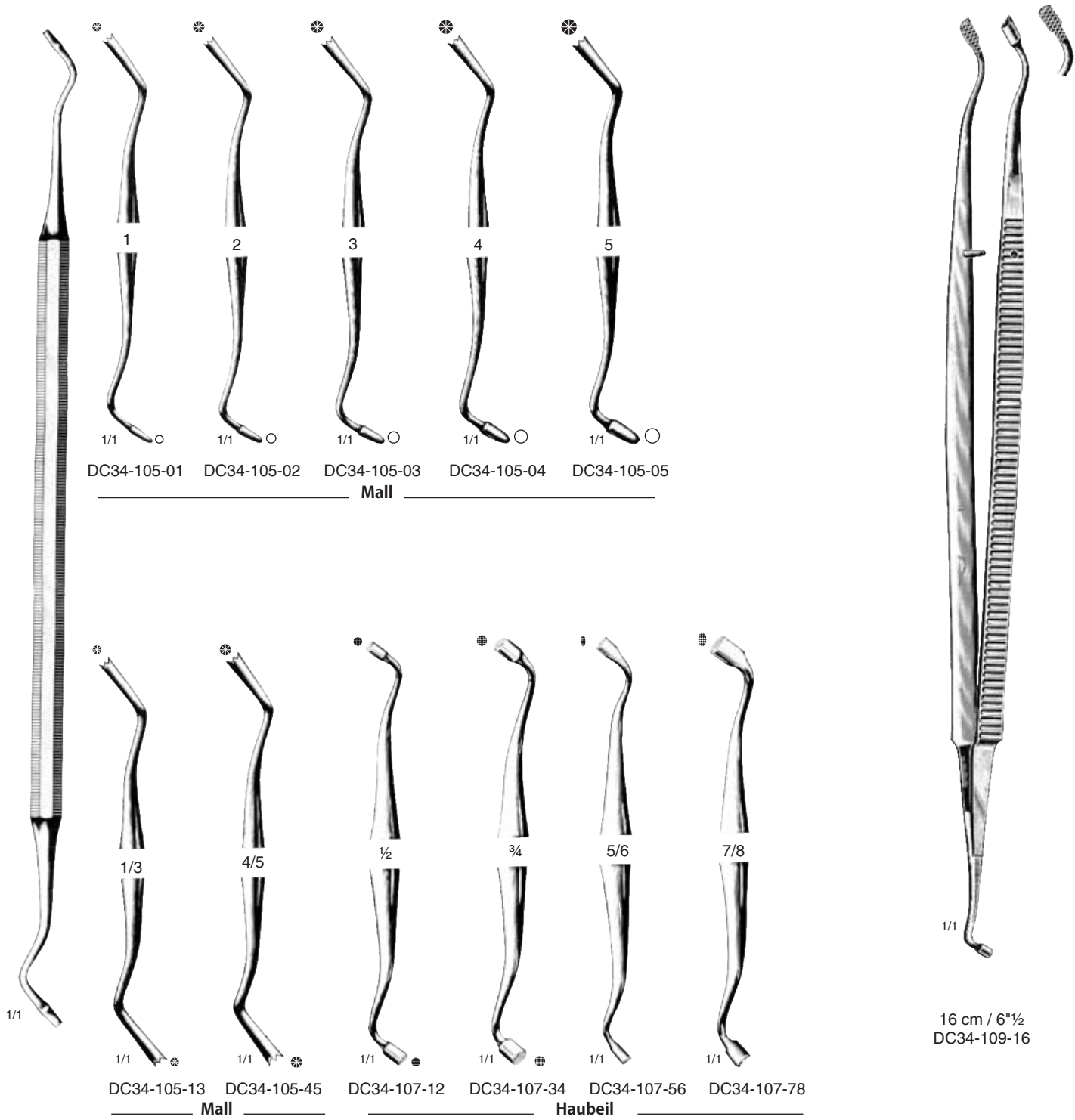

DC34-107-78	DC34-105-01	Amalgam Pluggers
	DC34-109-02	Amalgam Spetula
	DC34-111-16	Amalgam Plugging Pliers

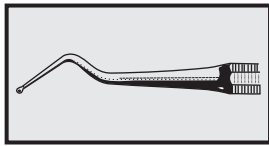

Instruments for Amalgam, Gutta-Percha and Cement



1/1	1/1	1/1	1/1	1/1	1/1	1/1	1/1
31	39	40	42	45	47	56	
Weston			Lewis		Foster-Flagg	Foster-Flagg	
DC34-113-31	DC34-115-39	DC34-115-40	DC34-115-42	DC34-115-45	DC34-117-47	DC34-117-56	
1/1	1/1	1/1	1/1	1/1	1/1	1/1	1/1
62	78	00	0	1	2	3	
Woodson	Woodson			Black			
DC34-119-62	DC34-121-78	DC34-123-00	DC34-123-10	DC34-123-01	DC34-123-02	DC34-123-03	
1/1	1/1	1/1	1/1	1/1	1/1	1/1	1/1
4	5	6	7	1	4		
		Black		Arrington	Arrington		
DC34-123-04	DC34-123-05	DC34-123-06	DC34-123-07	DC34-125-01	DC34-125-04		
1/1	1/1	1/1	1/1	1/1	1/1	1/1	1/1
5	10	11	19	20	24		
			Arrington				
DC34-125-05	DC34-125-10	DC34-125-11	DC34-125-19	DC34-125-20	DC34-125-24		

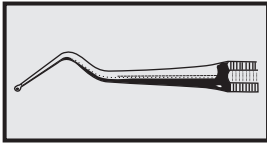

Instruments for Amalgam, Gutta-Percha and Cement

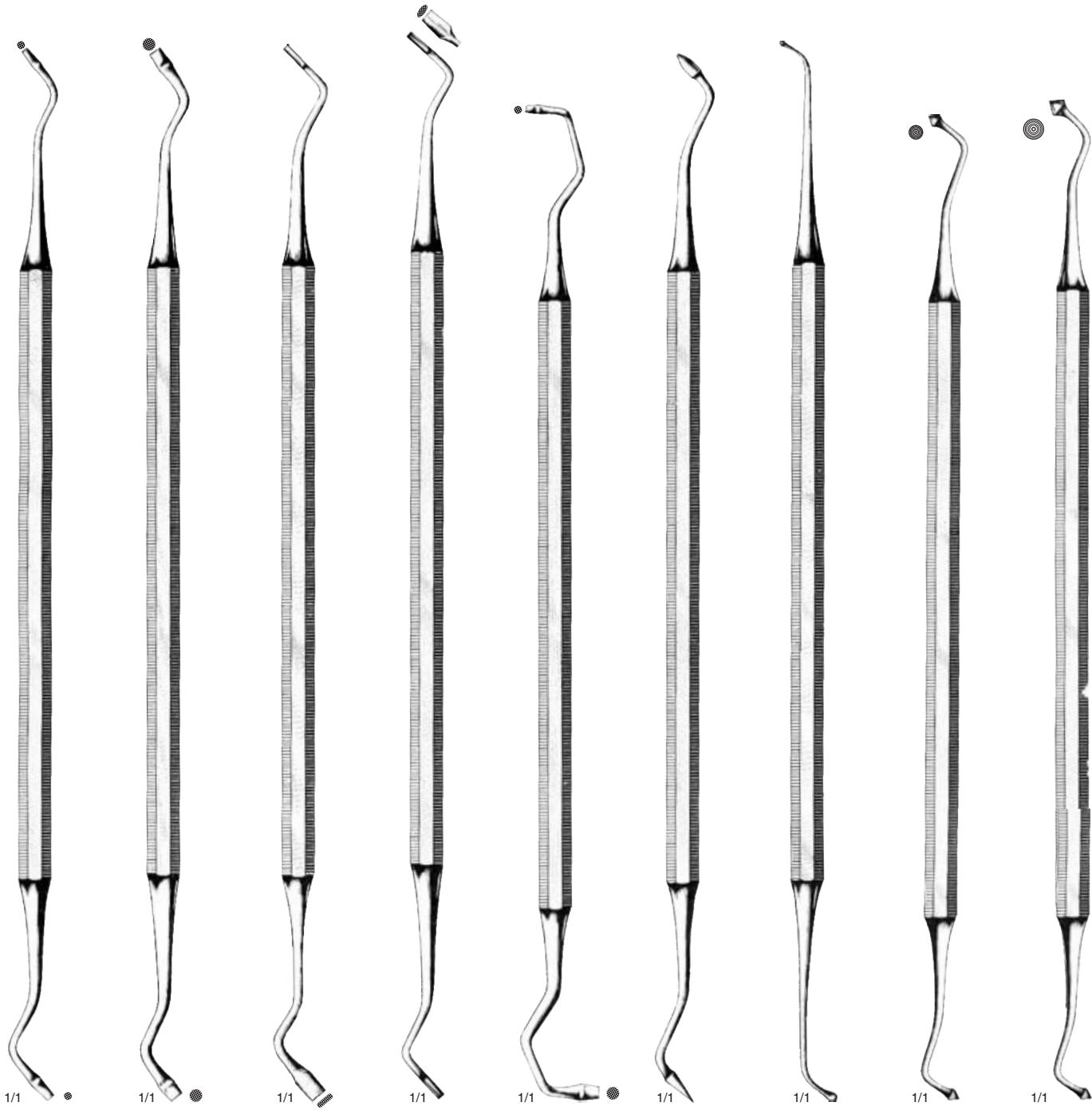

DC34-126-01 DC34-126-02 DC34-126-03 **Hollenback** DC34-126-04 DC34-126-05 DC34-126-06 DC34-126-07 **Mod. USA** DC34-127-01 **Mod. USA** DC34-127-02

DC34-126-01 DC34-127-02 Amalgam Condensers, Double-ended

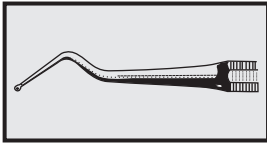

Amalgam Spoons



1/1
Pallas
DC34-128-01



1/1
DC34-129-01



1/1
Elliot
DC34-130-01

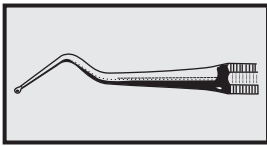

Amalgam Carriers

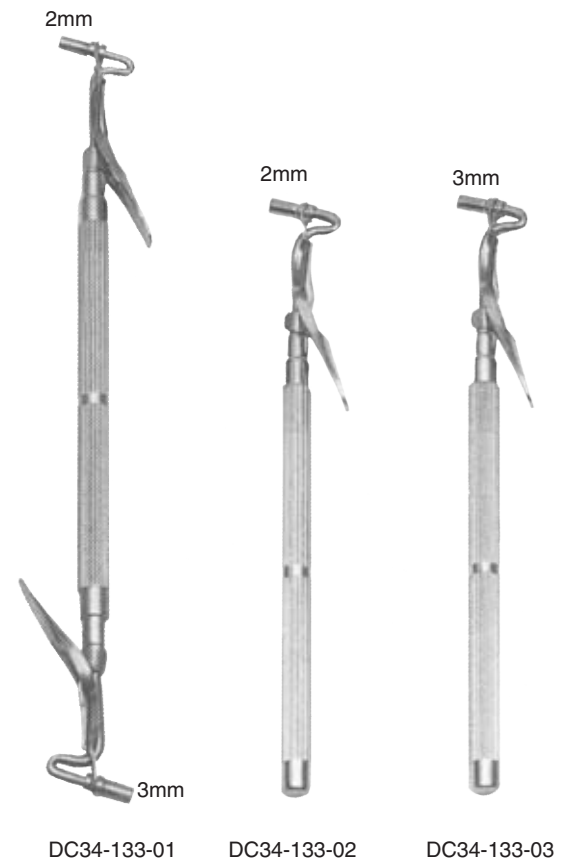
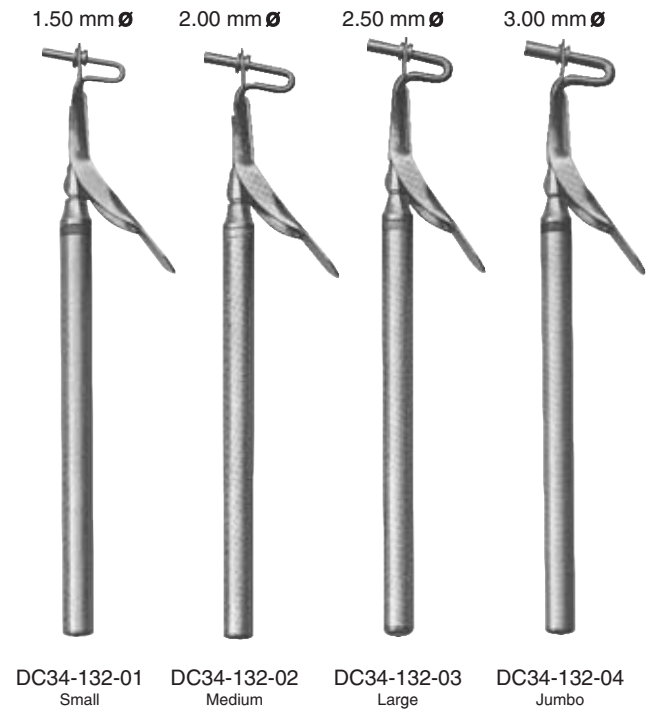
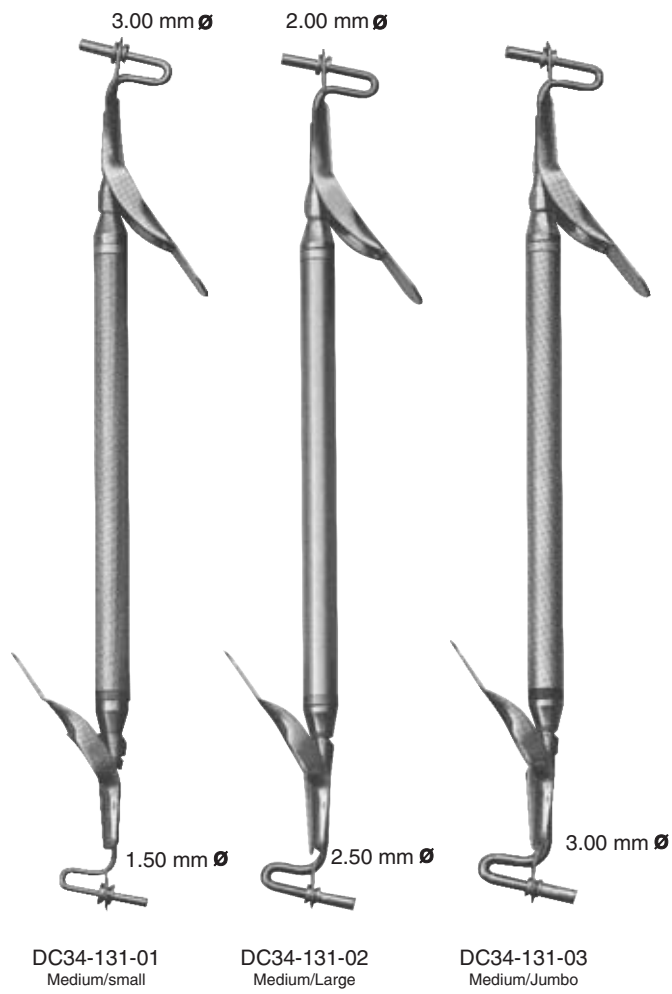

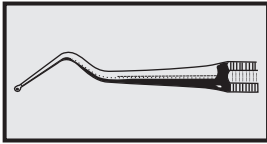

2/3

DC34-134-01
30 mm Ø

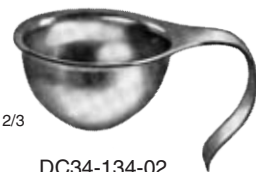

2/3

DC34-134-02
30 mm Ø



2/3

DC34-135-01



1/1

DC34-136-01

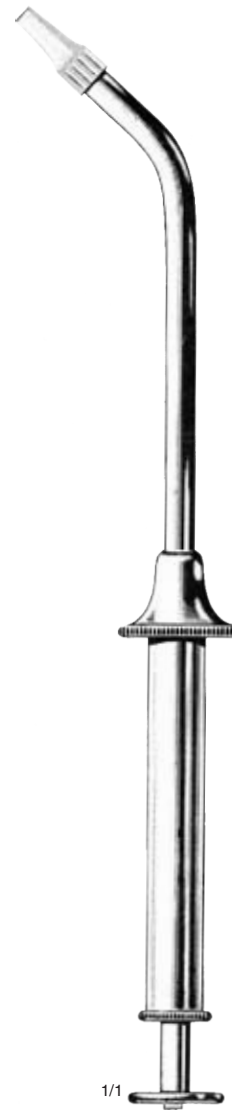

1/1

DC34-137-01



1/1

DC34-138-01

DC34-133-01	DC34-134-01	Finger Cups for pumice, amalgam, grinding paste
DC34-135-01		Mercury dispenser
DC34-136-01	DC34-138-01	Amalgam Guns

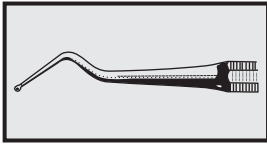

Instruments For Lifting
& Losing Temporary
Filling, Burnishers

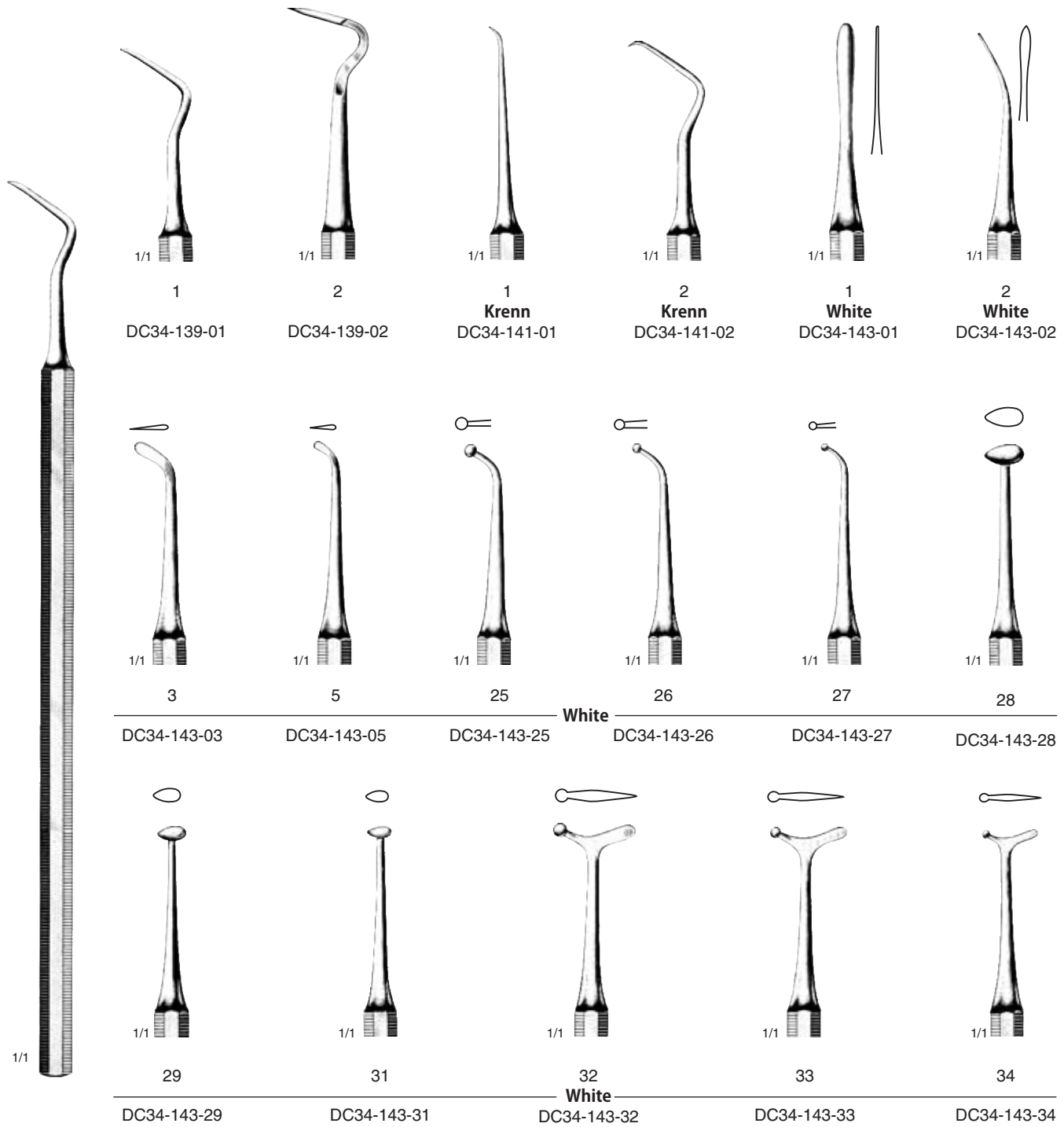

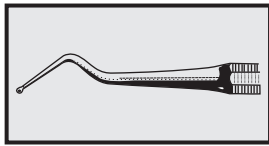

Plastic Filling Instruments

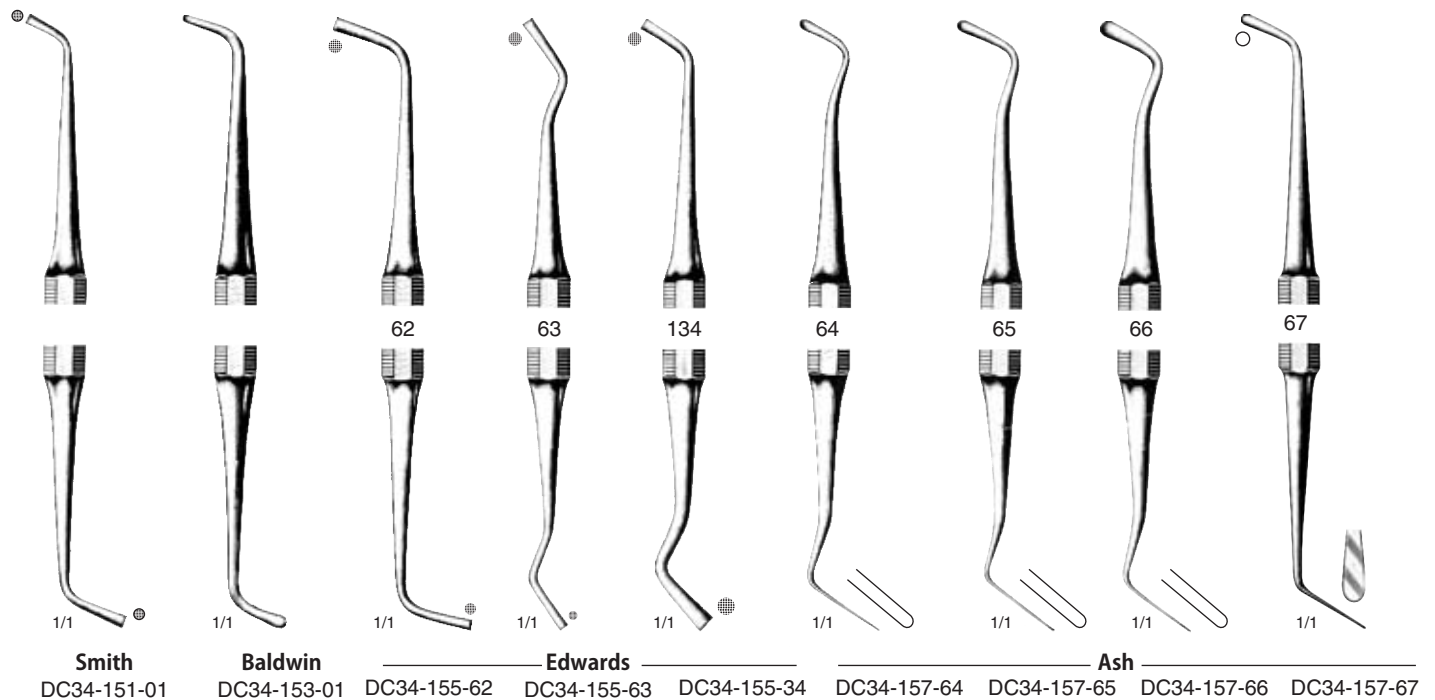
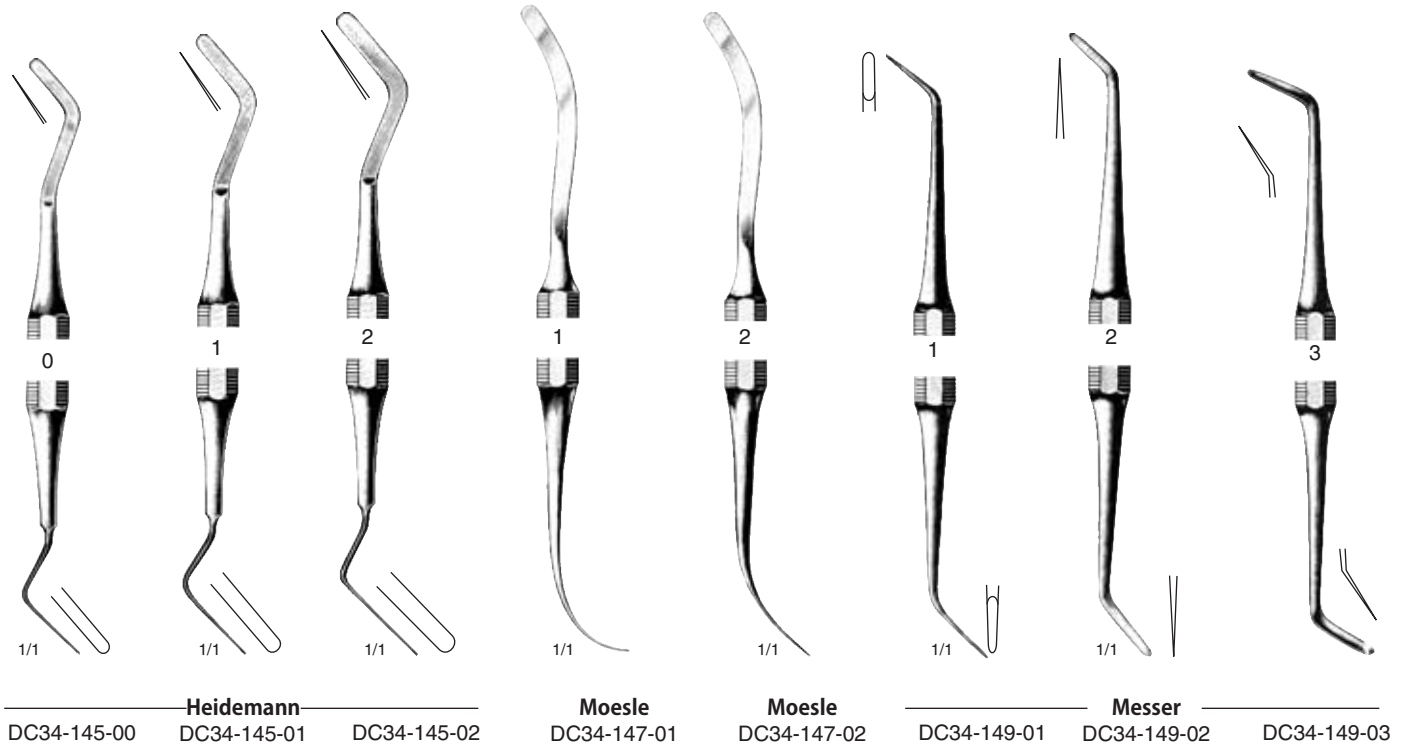

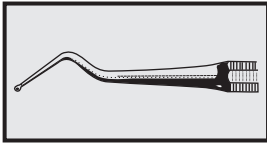

Plastic Filling Instruments

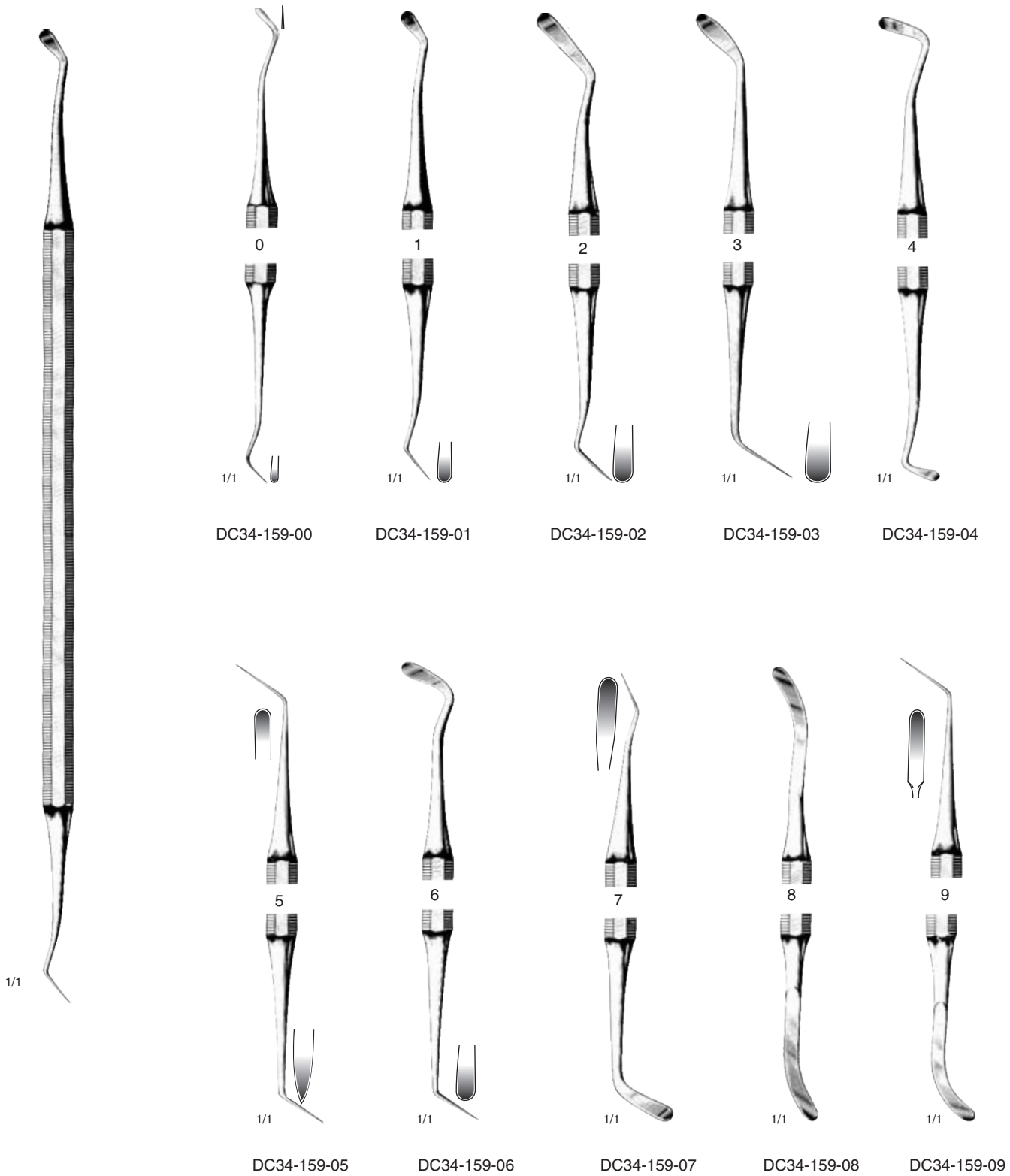

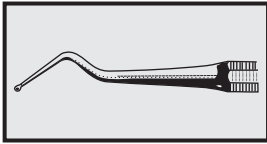

Plastic Filling Instruments



Ladmore
DC34-161-01



Ladmore
DC34-161-02

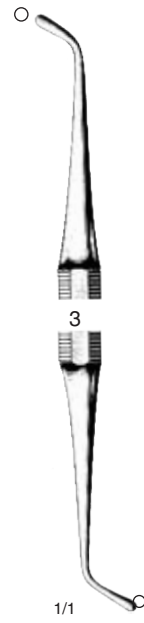

Ladmore
DC34-161-03

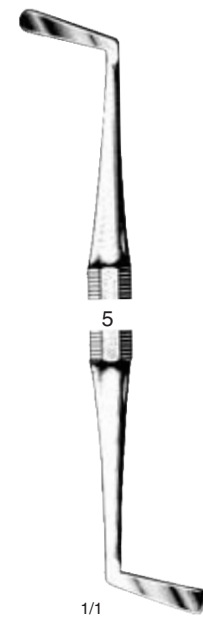

Ladmore
DC34-161-05



Ladmore
DC34-161-07

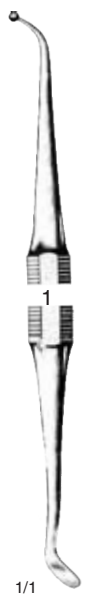

DC34-163-10



DC34-163-20

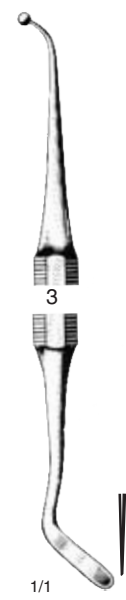

DC34-163-30

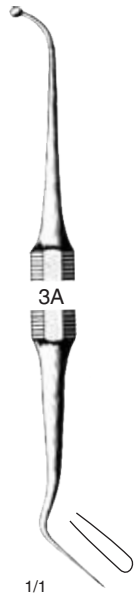

DC34-163-31

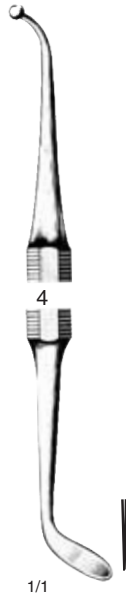

DC34-163-40

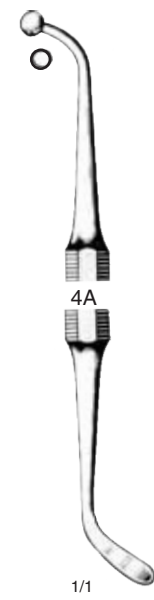

DC34-163-41

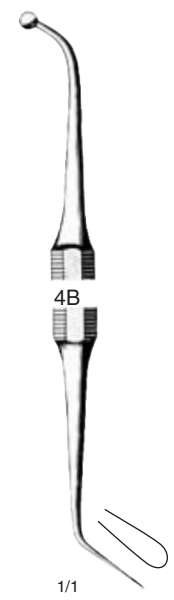

DC34-163-42

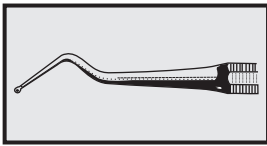

Plastic Filling Instruments

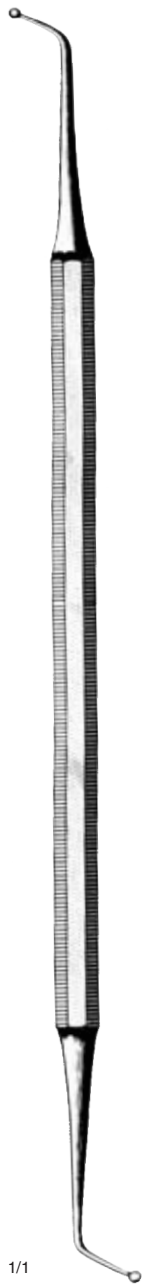

1/1



5

1/1

DC34-165-50



5A

1/1

DC34-165-51



5B

1/1

DC34-165-52



6

1/1

DC34-165-60



7

1/1

DC34-165-70



7A

1/1

DC34-165-71



7B

1/1

DC34-165-72



8

1/1

DC34-165-80

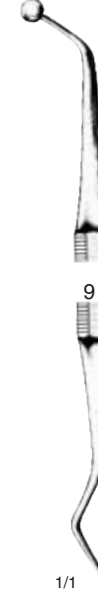

9

1/1

DC34-165-90

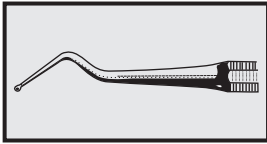

Plastic Filling Instruments

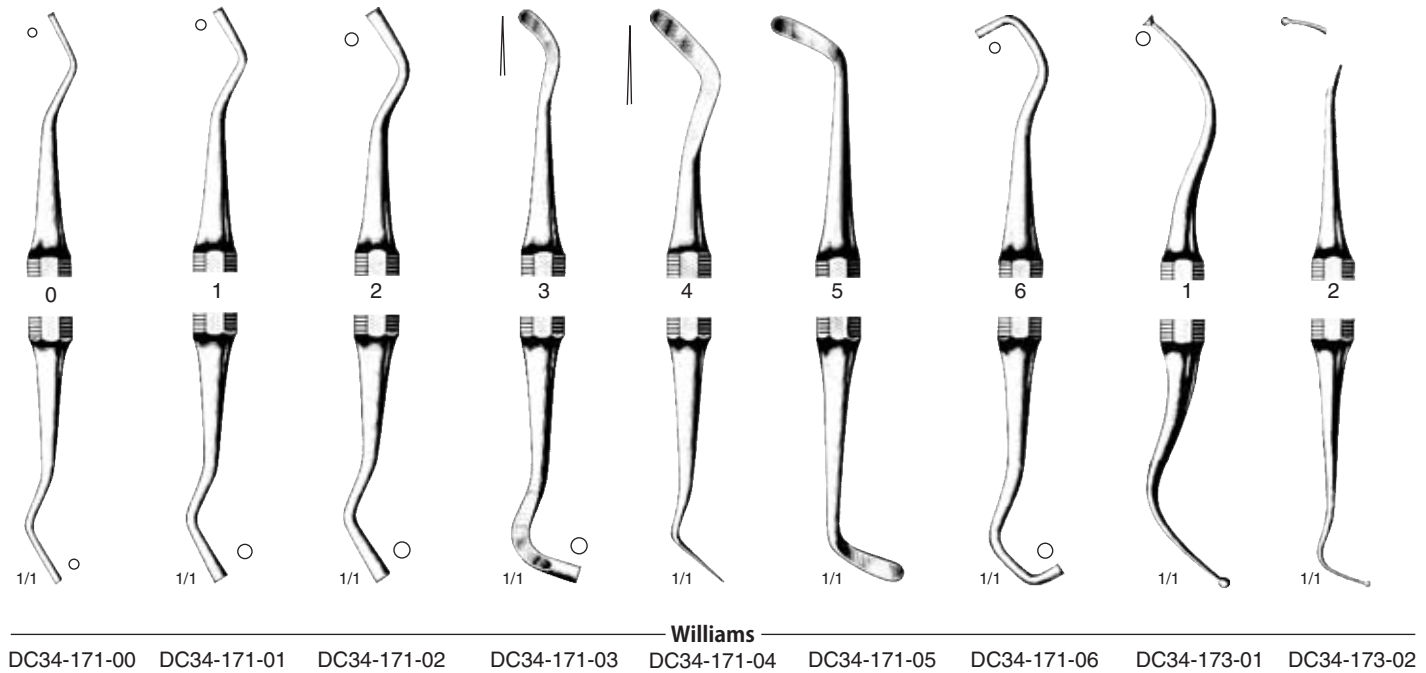
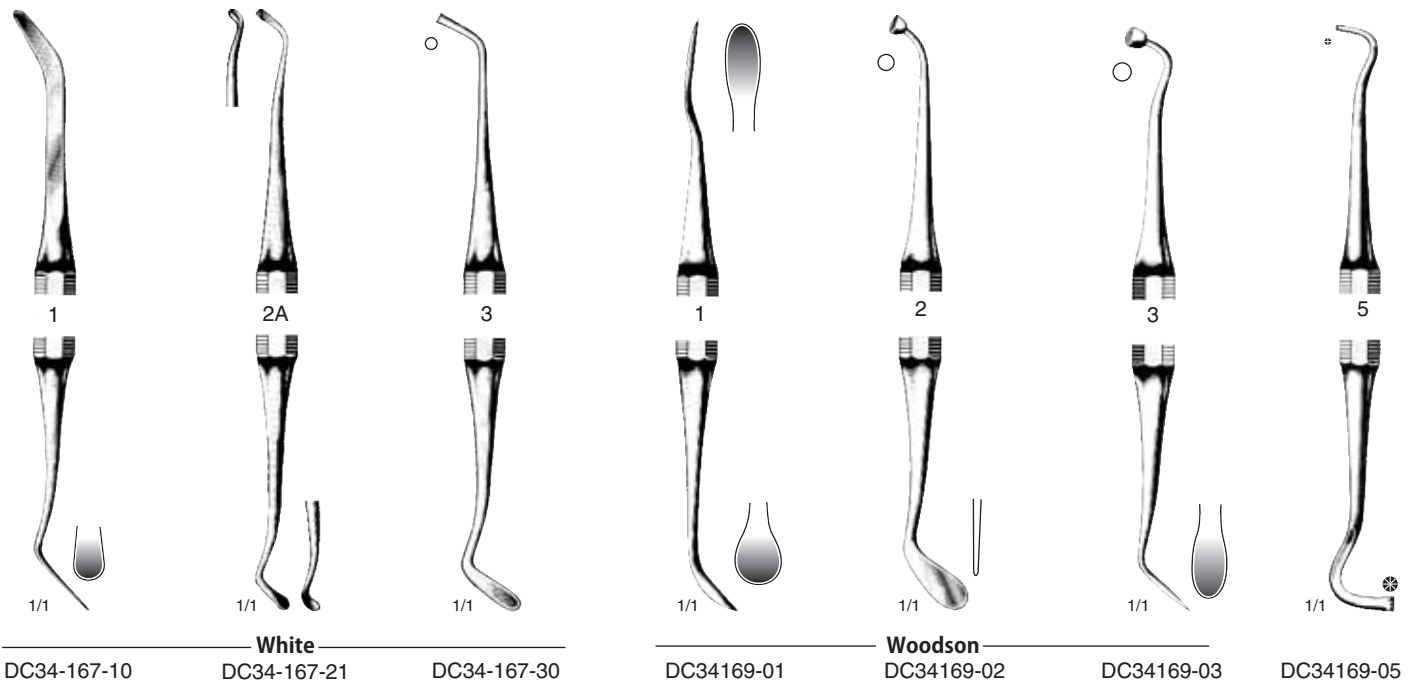

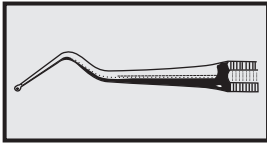

Plastic Filling Instruments

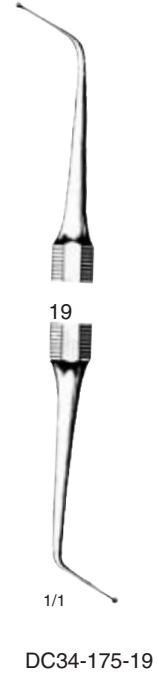
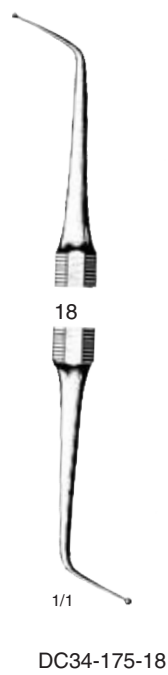
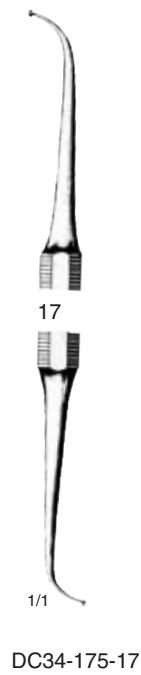
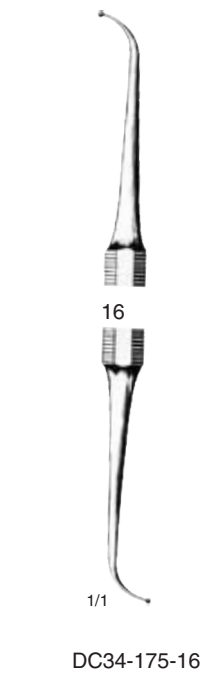
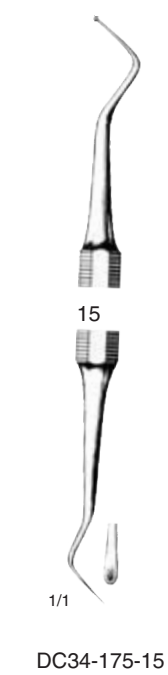
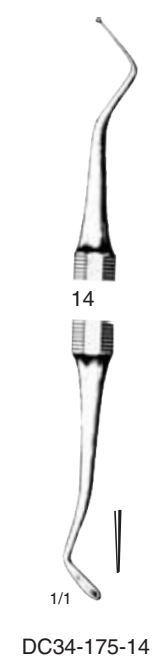
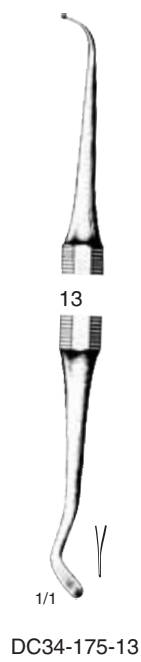
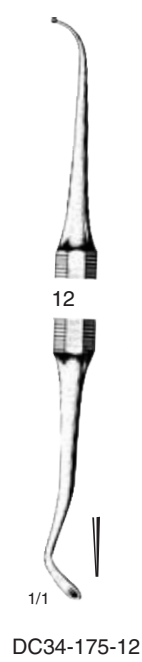
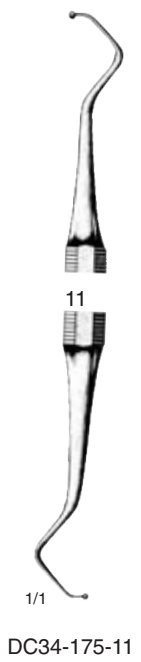
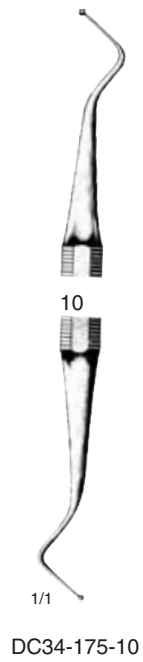
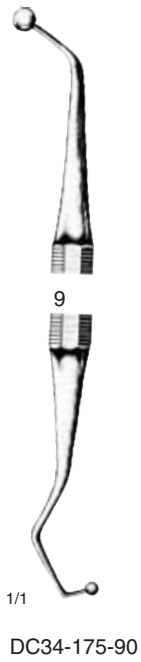

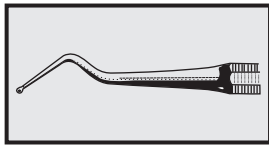

Plastic Filling Instruments

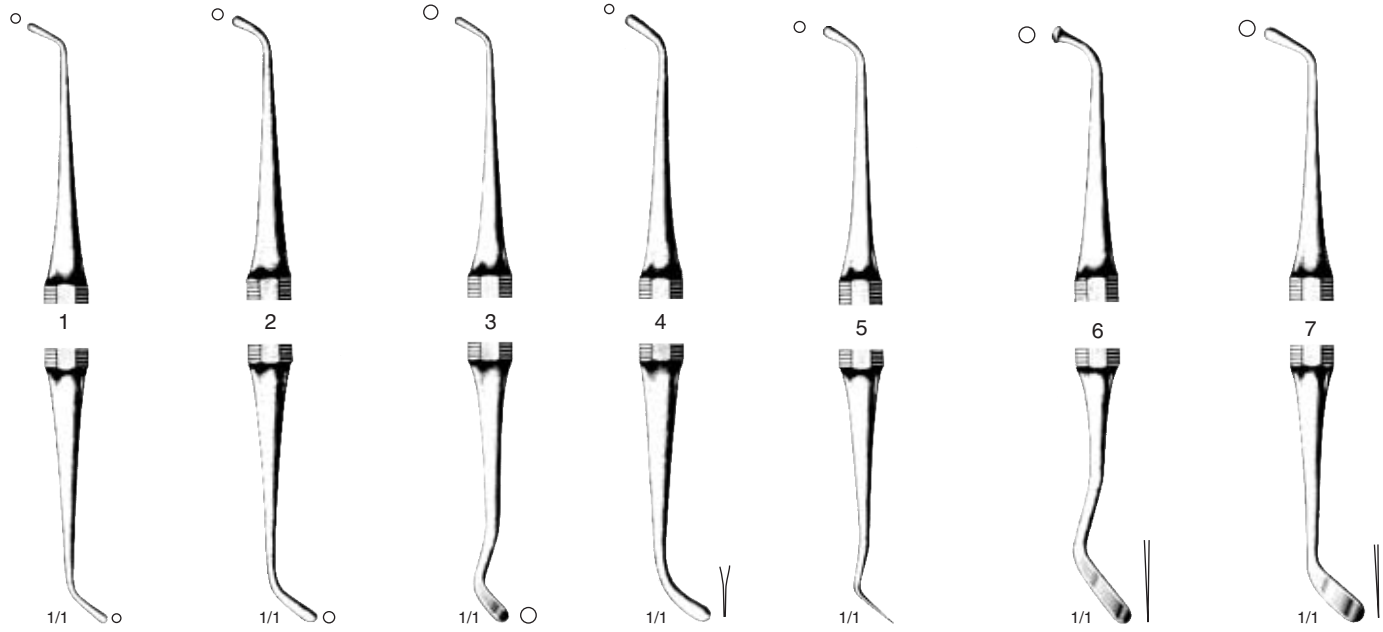

Ash

DC34-177-01 DC34-177-02 DC34-177-03 DC34-177-04 DC34-177-05 DC34-177-06 DC34-177-07

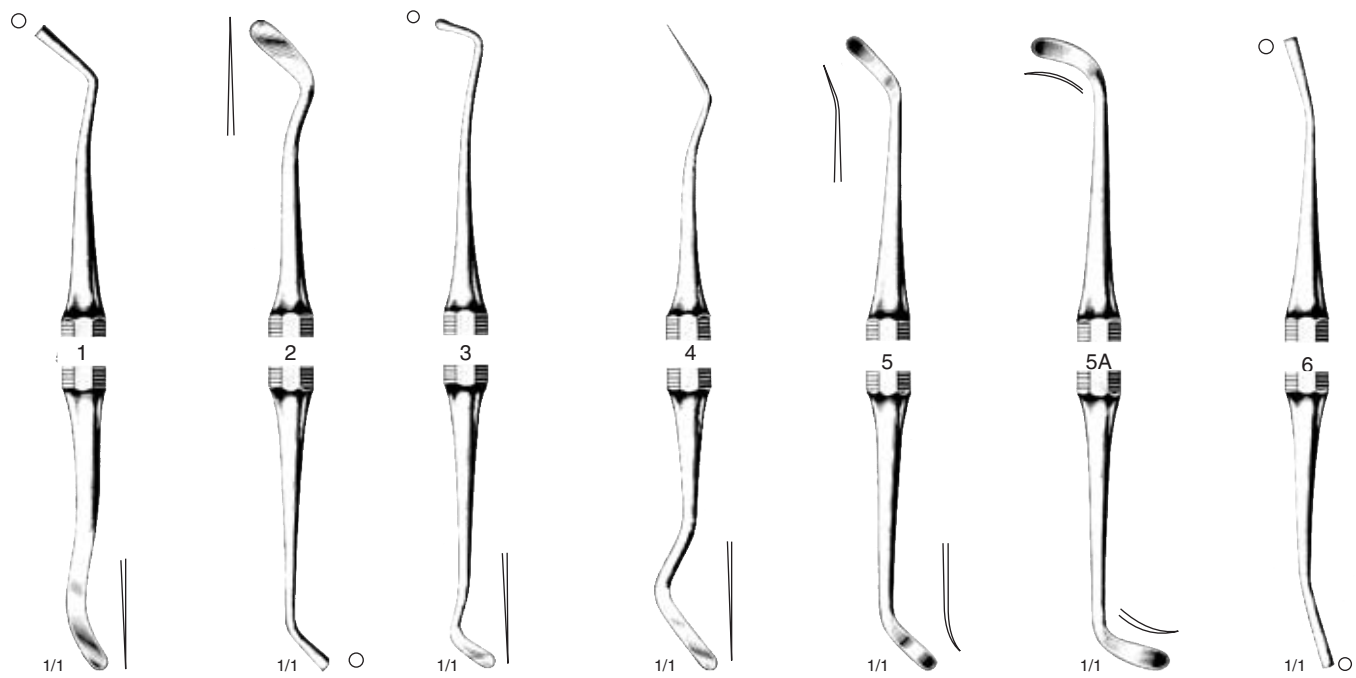

White

DC34-179-01 DC34-179-02 DC34-179-03 DC34-179-04 DC34-179-05 DC34-179-51 DC34-179-06

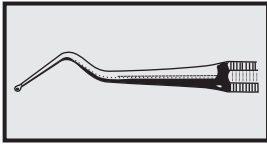

Filling Instruments

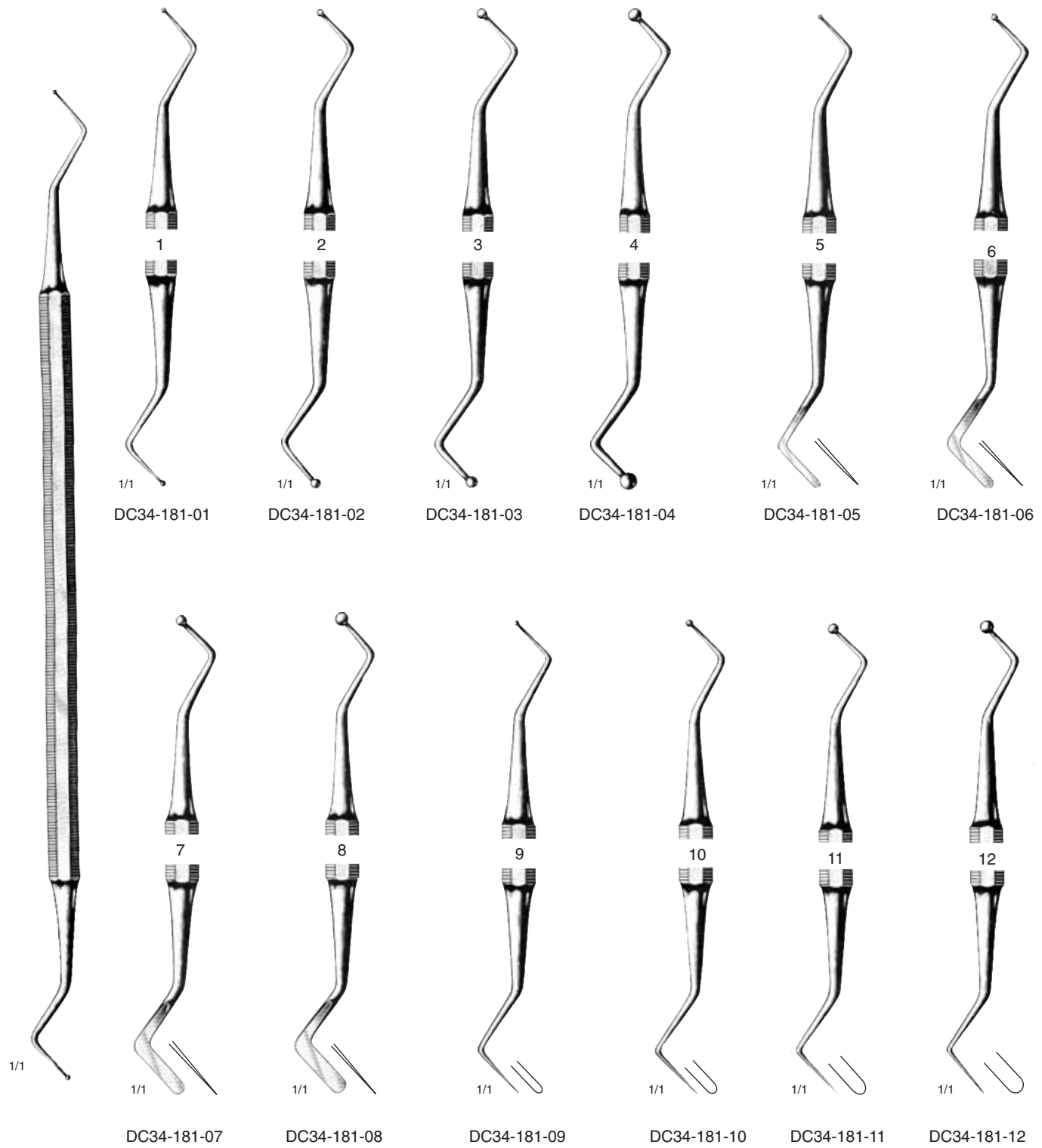

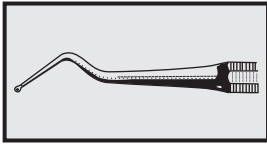

Filling Instruments

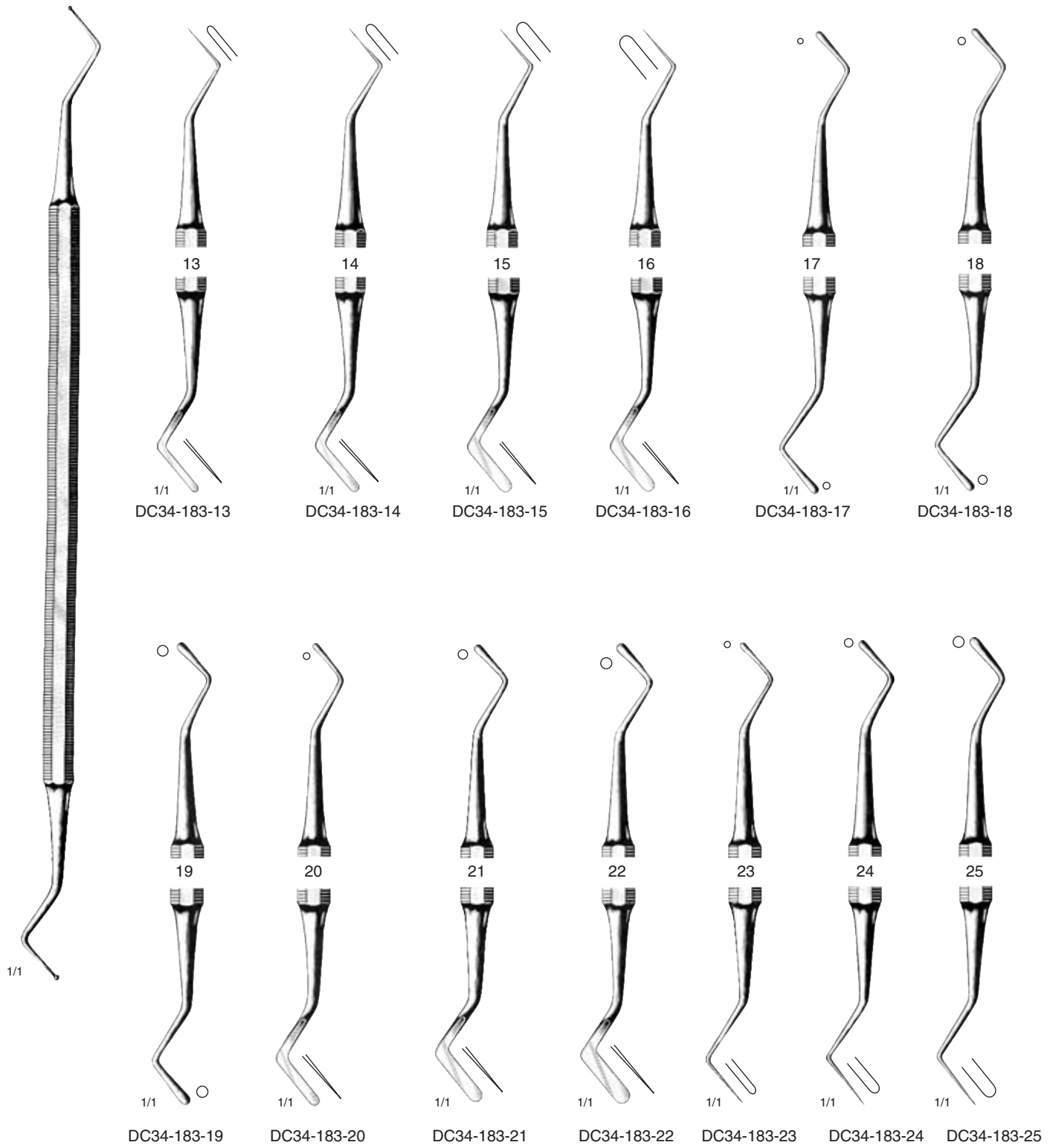

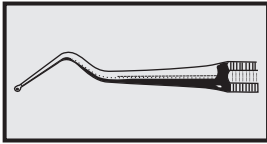

Amalgam & Filling Instruments

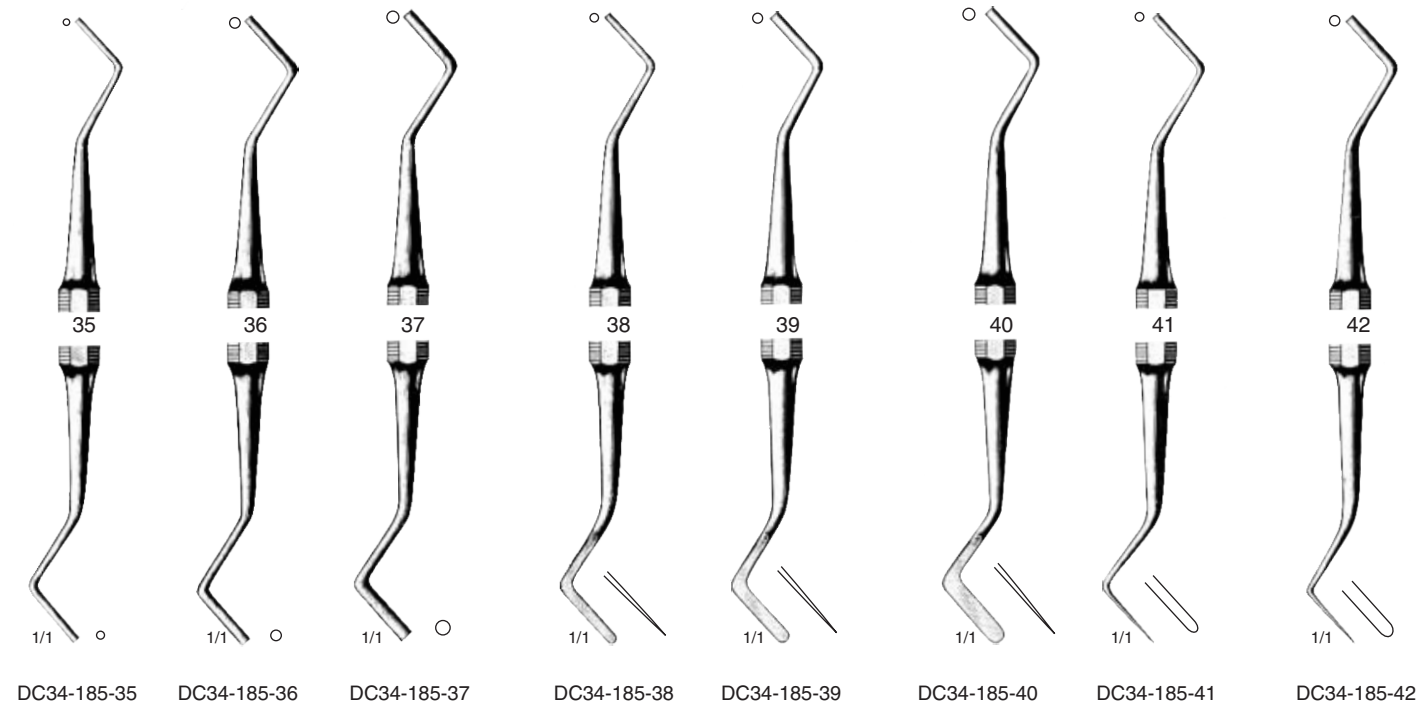
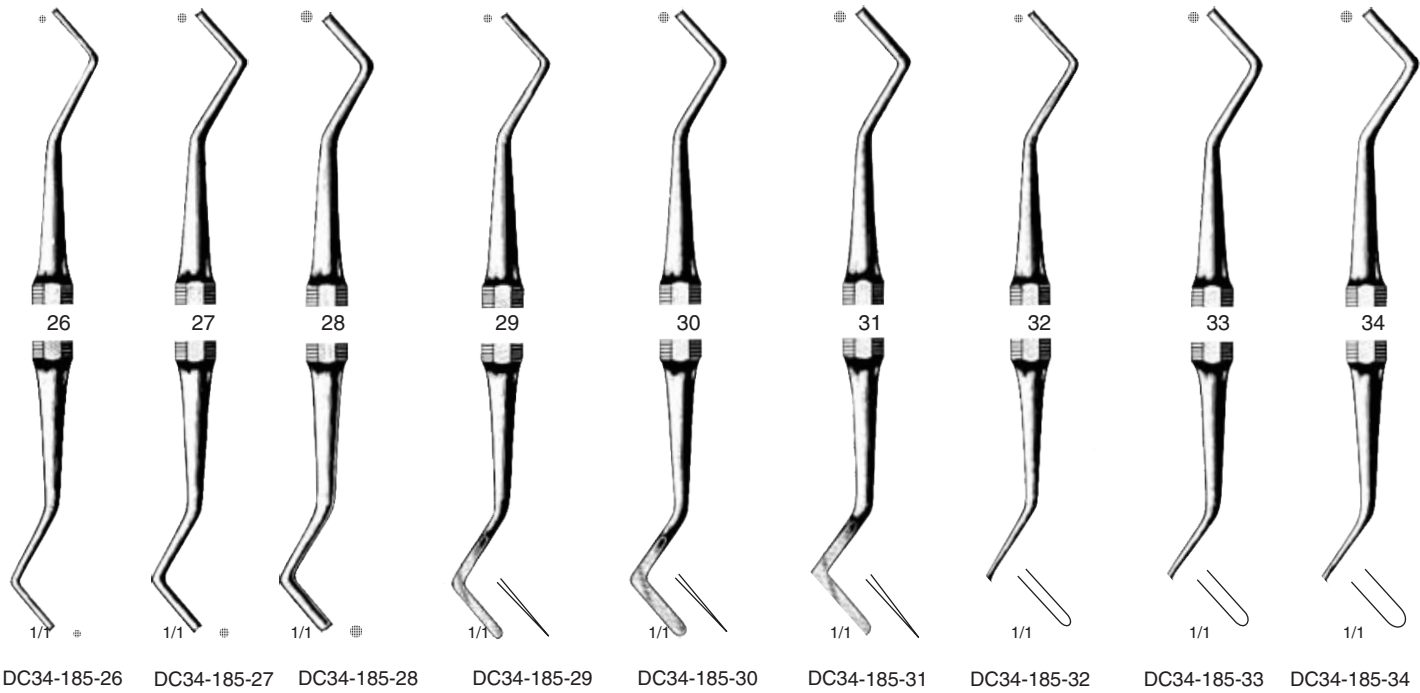

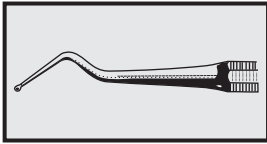

Contra Angle Instruments

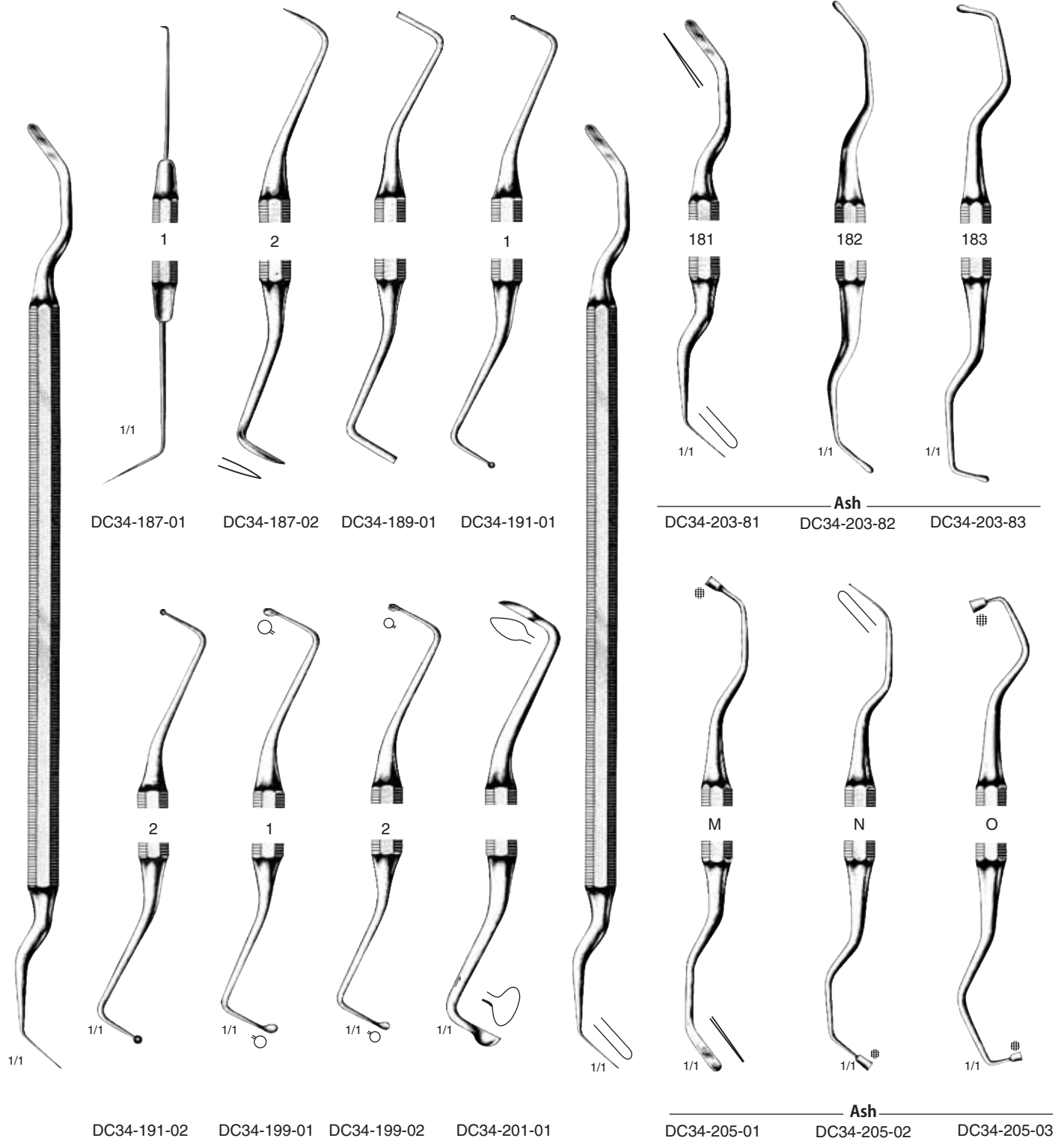

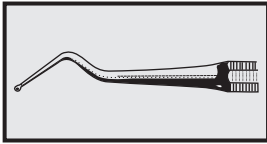

Plastic Filling Instruments

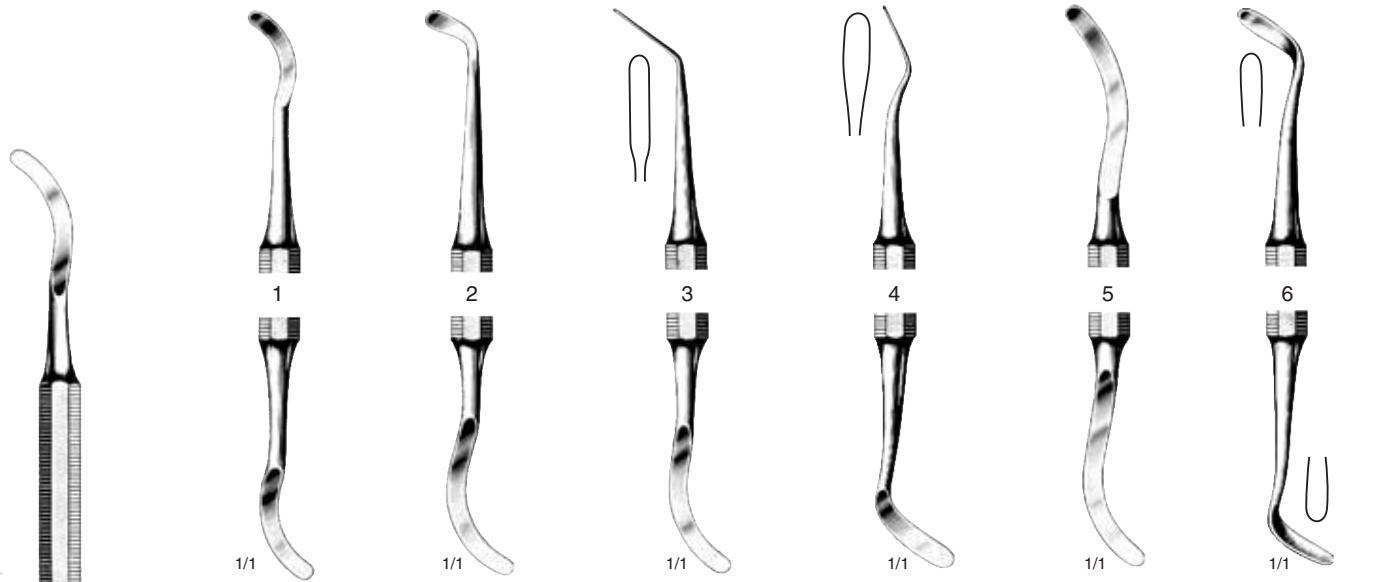

Linsemann

DC34-207-01 DC34-207-02 DC34-207-03 DC34-207-04 DC34-207-05 DC34-207-06

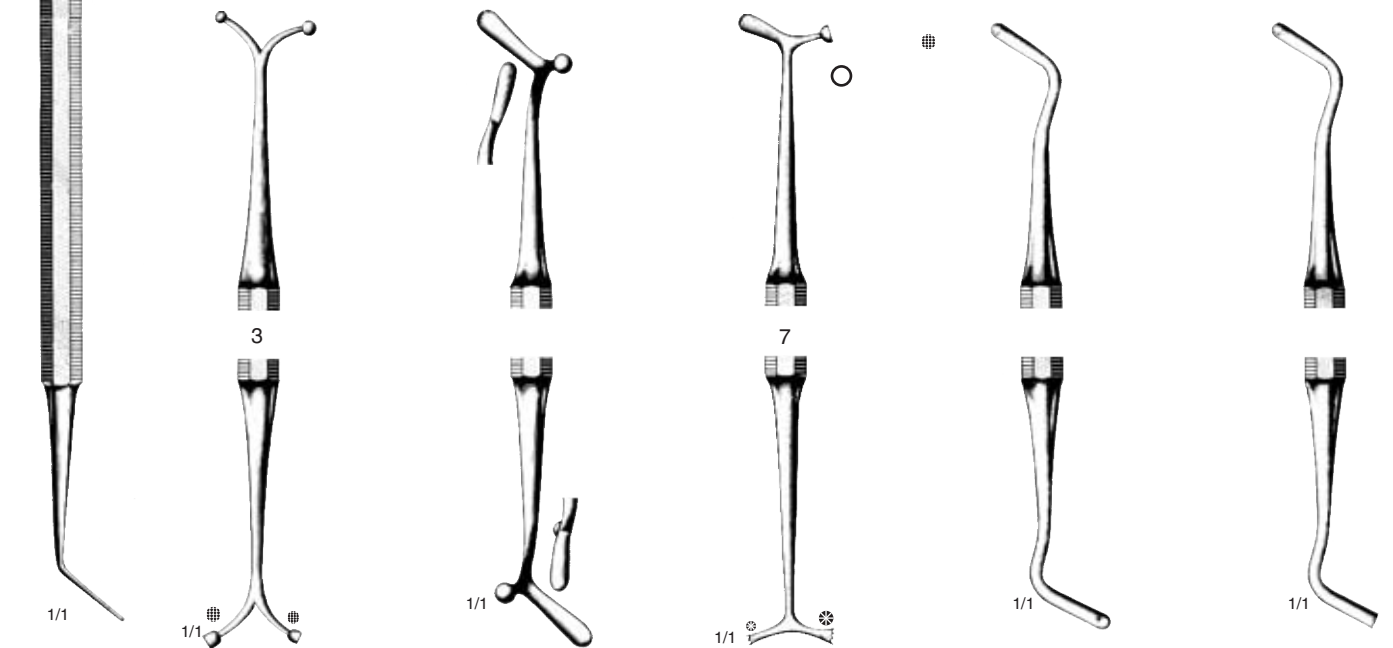

Vajna **Vajna** **Bennet**

DC34-209-03 DC34-211-01 DC34-213-07 DC34-215-01 DC34-217-02

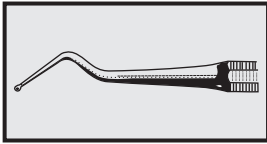

Cement Spatula, Silicate Spatula

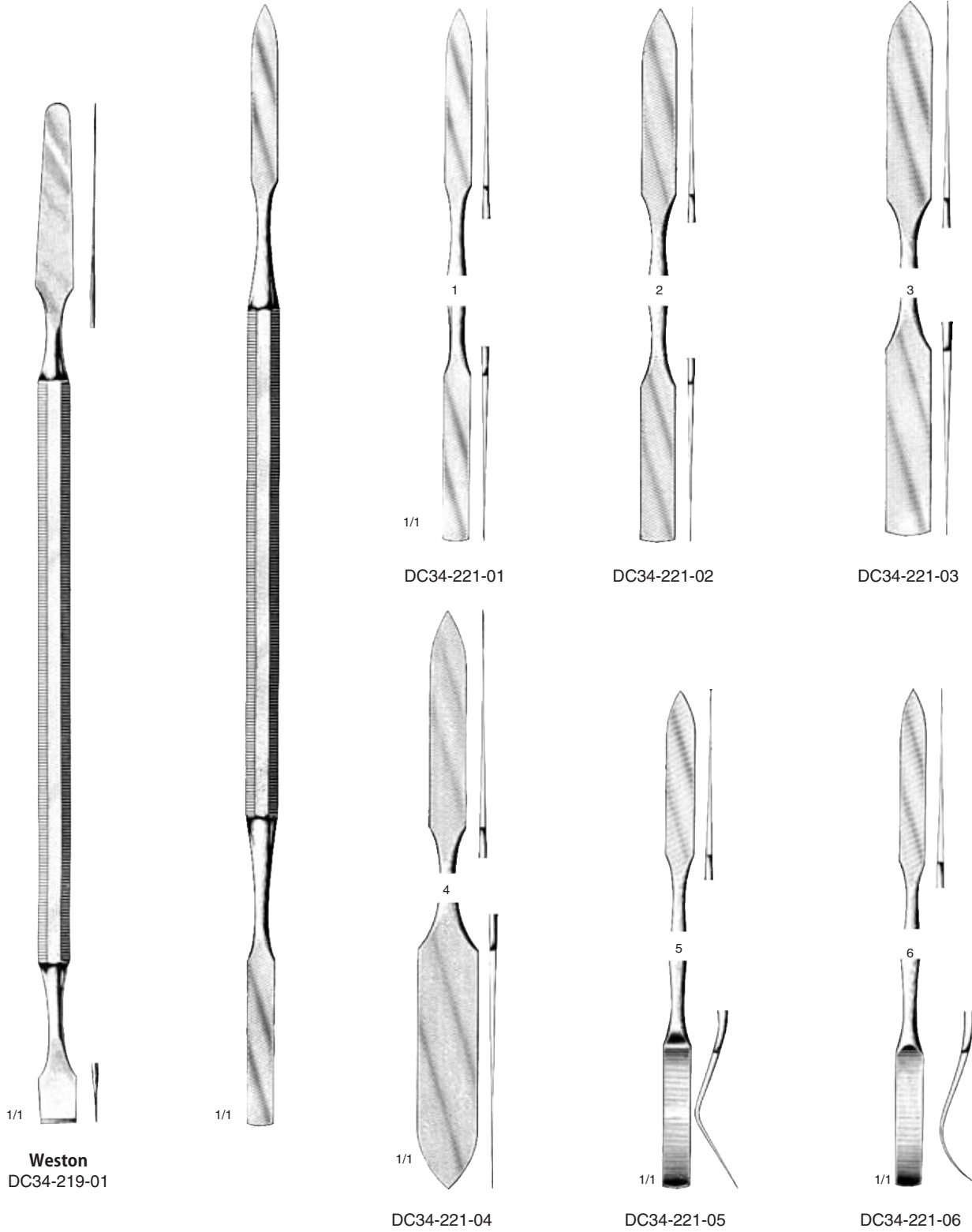

DC34-219-01 DC34-221-05 Cement Spatula

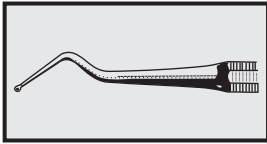

Cement Spatula



1/1

DC34-223-01



1/1

DC34-225-01



1/1

Mall-Roundoflex



1

1/1

DC34-227-01



2

DC34-227-02



3

1/1

DC34-227-03

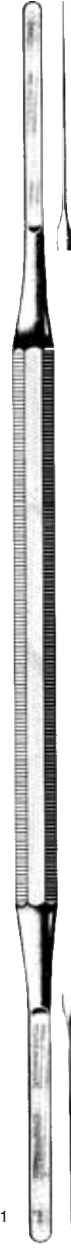

1/1

DC34-229-01

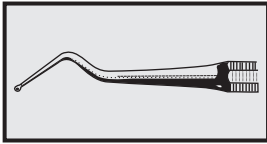

Gutta-Percha and Cement Speculas

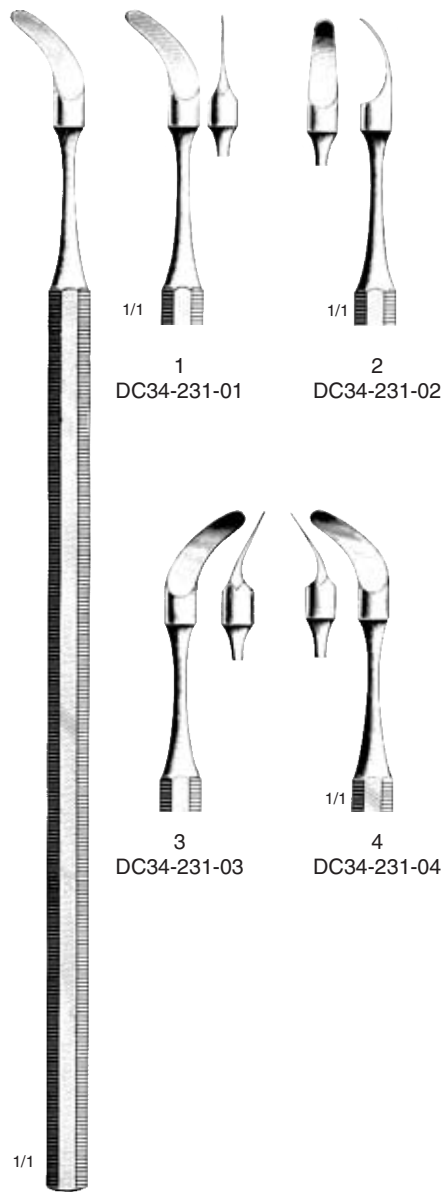

Hunt

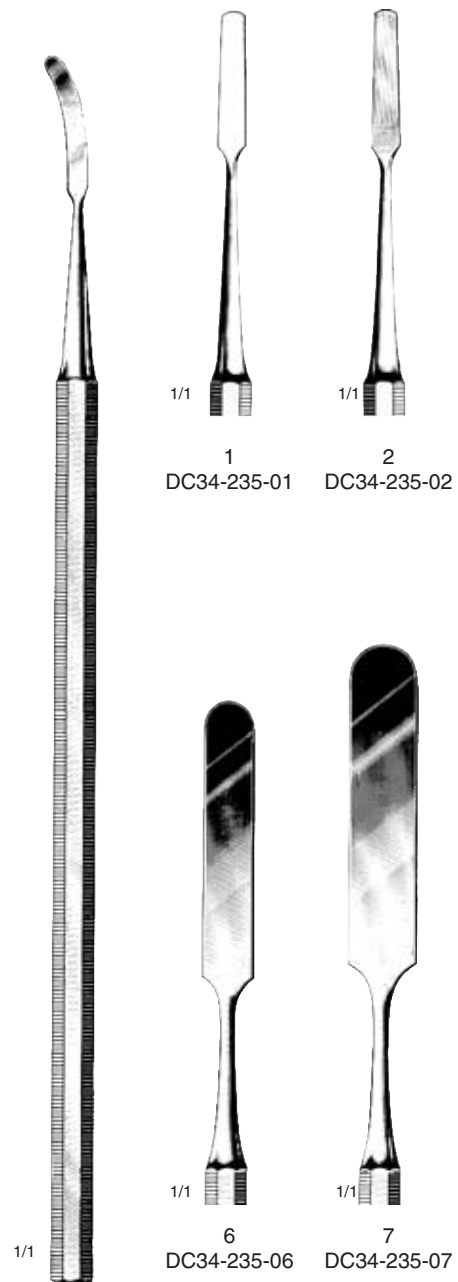
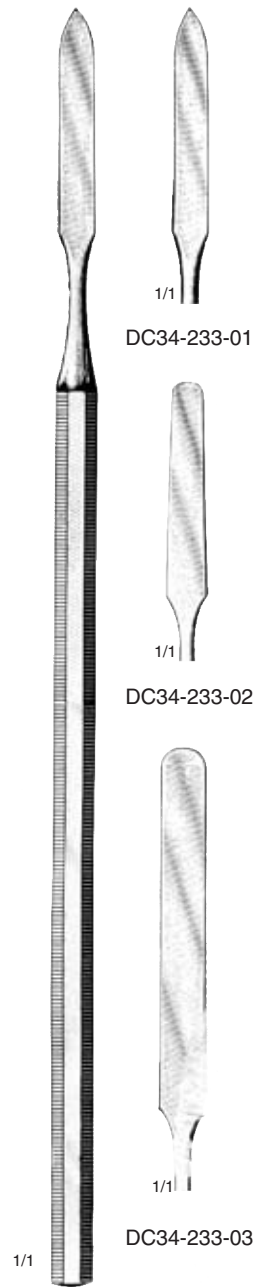

Ivory

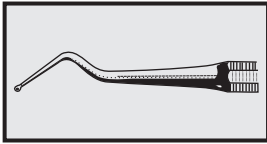

Fine Spatulas, Laboratory Spatulas
Spatulas For Plaster & Alginates



150 X 3 mm \emptyset
DC34-172-03



130 X 2 mm \emptyset DC34-237-02
185 x 2 mm \emptyset DC34-239-02
210 x 2 mm \emptyset DC34-241-02



DC34-243-02
DC34-245-02
DC34-247-02



100 X 2 mm \emptyset DC34-249-02
130 x 2 mm \emptyset DC34-251-02
150 x 2 mm \emptyset DC34-253-02



DC34-255-02
DC34-257-02
DC34-259-02



150 X 3 mm \emptyset DC34-261-03
185 x 3 mm \emptyset DC34-263-03
210 x 3 mm \emptyset DC34-265-03



130 X 4 mm \emptyset DC34-267-04
155 x 4 mm \emptyset DC34-269-04



17.5 cm / 7"
DC34-207-17

19 cm / 7½" DC34-271-19
22 cm / 8¼" DC34-273-22
25 cm / 10" DC34-275-25
28 cm / 11" DC34-277-28
30 cm / 12" DC34-279-30
35 cm / 14" DC34-281-35



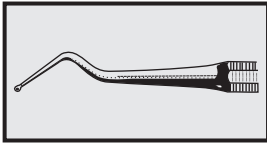

Matrix Retainer



1/1

Didner
DC34-283-01



1/1

Ivory
DC34-285-01



1/1

Ivory
DC34-287-01



1/1

Ivory
DC34-289-01



DC34-291-20 = 20 mm Ø
DC34-291-25 = 25 mm Ø
DC34-291-30 = 30 mm Ø



1/1

Ivory
DC34-293-01



1/1

Ivory
DC34-295-01



1/1

Ivory
DC34-297-01

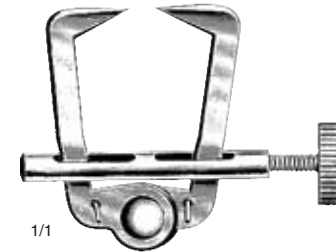

1/1

Elliot
DC34-299-01

DC34-283-01	DC34-289-01	Matrix Retainer
DC34-291-20	DC34-291-30	Rubber-dam Holder
DC34-293-01	DC34-295-01	Matrix Retainer
DC34-297-01	DC34-299-01	Separators

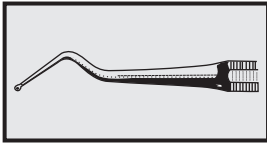

Matrix Pliers, Rubber-Dam Punch
& Clamp Forceps



17 cm / 6¾"

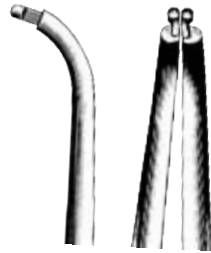

DC34-301-17



DC34-303-17

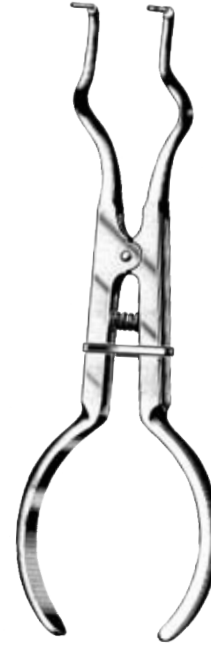

Brewer
17 cm / 6¾"
DC34-305-17



Ivory
17 cm / 6¾"
DC34-307-17

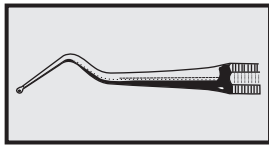

Rubber Dam Clamps



DC34-309-01



DC34-309-02



DC34-309-03



DC34-309-04



DC34-309-05



DC34-309-06

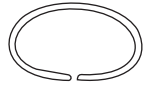

DC34-309-07



DC34-309-08

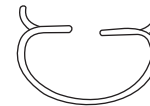

DC34-311-01



DC34-311-02



DC34-311-03



DC34-311-04



DC34-311-05



DC34-311-06



DC34-311-07

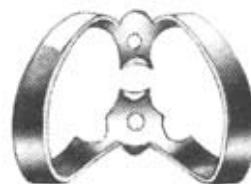

DC34-311-08



DC34-311-09

DC34-309-01	DC34-309-05	Molar Clamps
DC34-309-06	DC34-309-08	Bicuspid Clamps
DC34-311-01	DC34-311-06	Molar Clamps
DC34-311-07	DC34-311-09	Labial Clamps

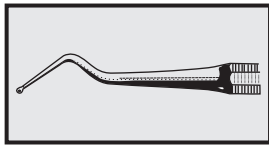

Rubber Dam Clamps



DC34-313-10



DC34-313-11



DC34-313-12



DC34-313-13

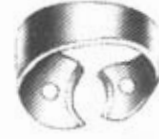

DC34-313-14



DC34-313-15



DC34-313-16



DC34-313-17

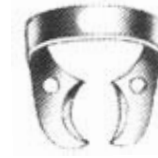

DC34-313-18



DC34-313-19



DC34-313-20



DC34-313-21



DC34-313-22



DC34-313-23



DC34-313-24



DC34-313-25



DC34-313-26



DC34-313-27

DC34-313-10	DC34-313-14	Molar Clamps
DC34-313-15	DC34-313-20	Molar Clamps
DC34-313-21	DC34-313-27	Bicuspid Clamps

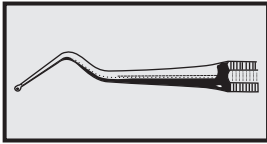

Matrix Band and Matrix Retainer

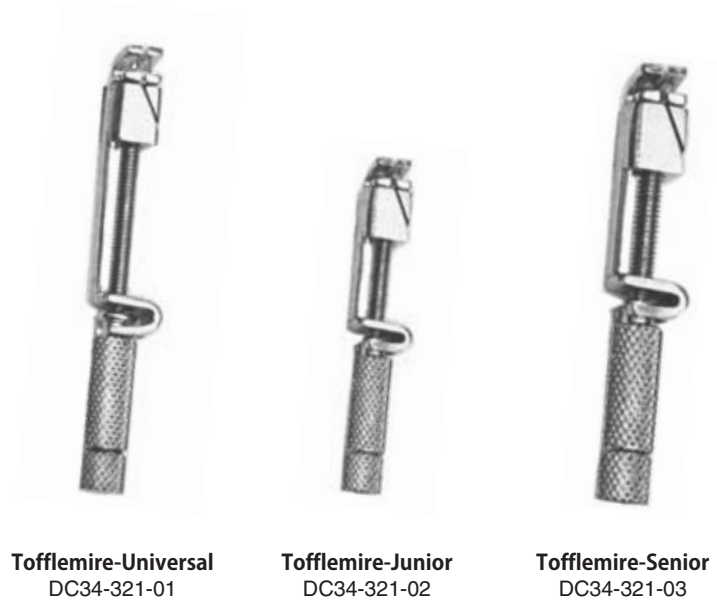
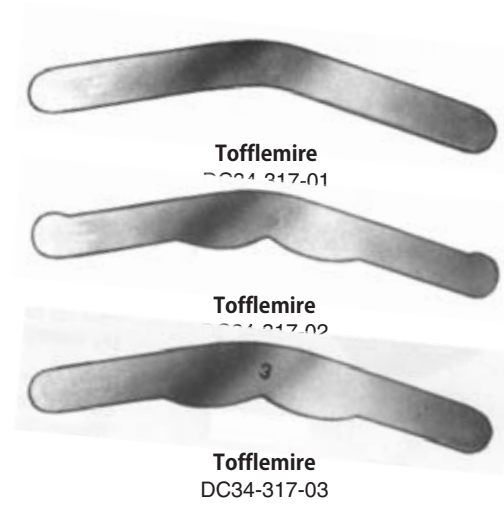
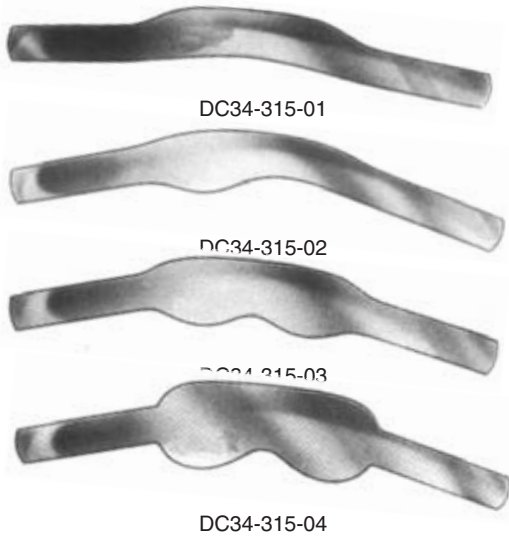

DC34-315-01	DC34-319-03	Matrix Bands
DC34-321-01	DC34-321-03	Matrix Retainer

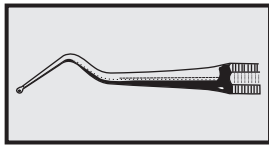

Scalers for Periodontosis and Pyorrhea

Periodontosis Instruments

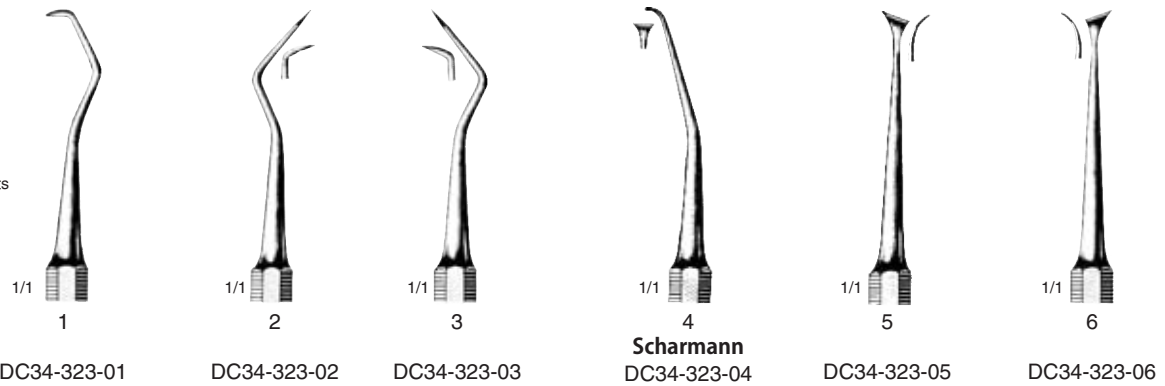

Periodontosis Instruments



Periodontosis Instruments



Files for Prophylaxis

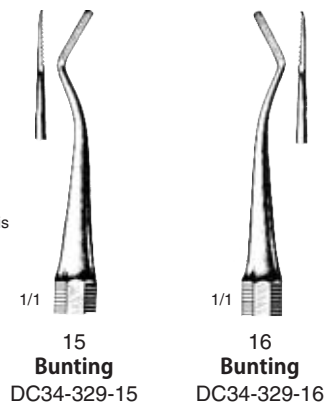

Files for Prophylaxis

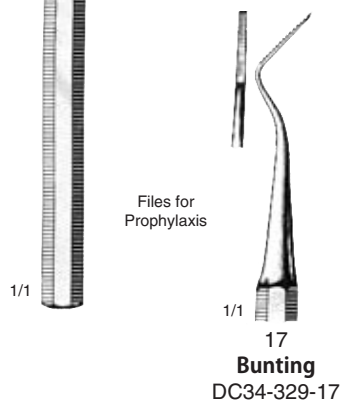

Pyorrhea Instruments

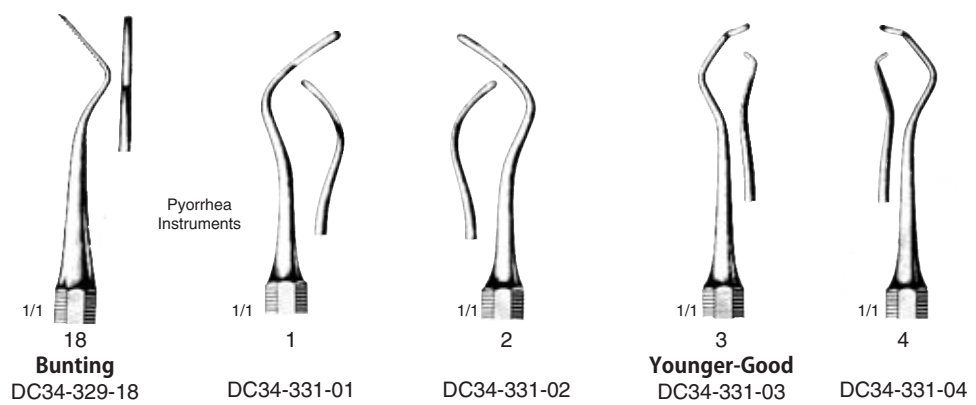

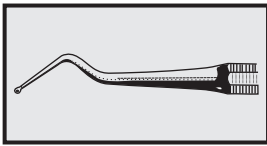







Scalers for Periodontosis and Pyorrhea







1/1



Pyorrhea Instruments

					
1/1	1/1	1/1	1/1	1/1	1/1
5	6	7	8	9	10
Younger-Good	Younger-Good	Younger-Good	Younger-Good	Younger-Good	Younger-Good
DC34-333-05	DC34-333-06	DC34-333-07	DC34-333-08	DC34-333-09	DC34-333-10



Pyorrhea Instruments

				
1/1	1/1	1/1	1/1	1/1
11	12	13	14	15
Younger-Good	Younger-Good	Younger-Good	Younger-Good	Younger-Good
DC34-333-11	DC34-333-12	DC34-333-13	DC34-333-14	DC34-333-15

Pyorrhea Instruments

		
1/1	1/1	1/1
Globe	7	8
DC34-335-02		

Periodontosis Files

	
1/1	1/1
Muehle	Muehle
DC34-337-07	DC34-337-08

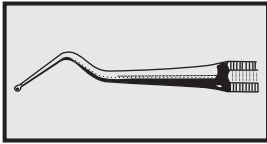

Scalers for Periodontosis and Pyorrhea



1/1

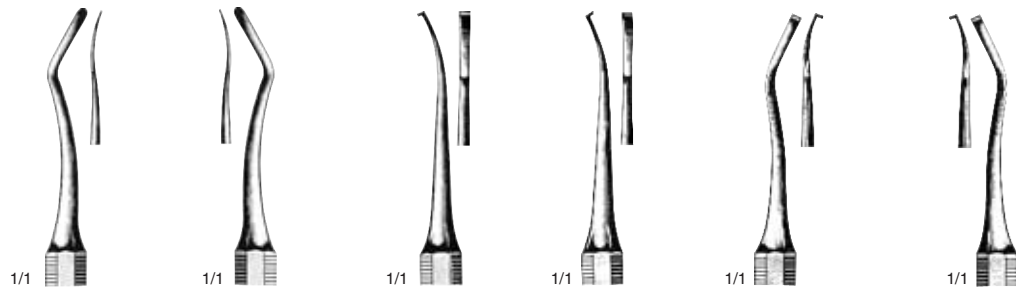

Black					
1	2	3	4	5	6
DC34-339-01	DC34-339-02	DC34-339-03	DC34-339-04	DC34-339-05	DC34-339-06
15	15	15	15	15	15
8	8	F	B	8	8
6	6			6	6
L	R			L	R

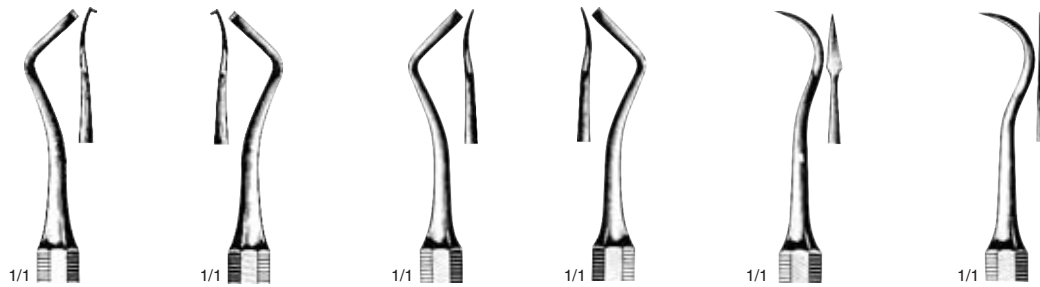

Black					
7	8	9	10	11	12
DC34-339-07	DC34-339-08	DC34-339-09	DC34-339-10	DC34-339-11	DC34-339-12
15	15	15	15	25	20
8	8	8	8		
6	12	12	12		
R	R	L	R		

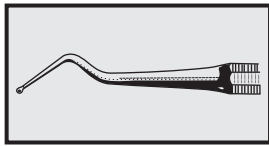

Scalers for Periodontosis and Pyorrhea

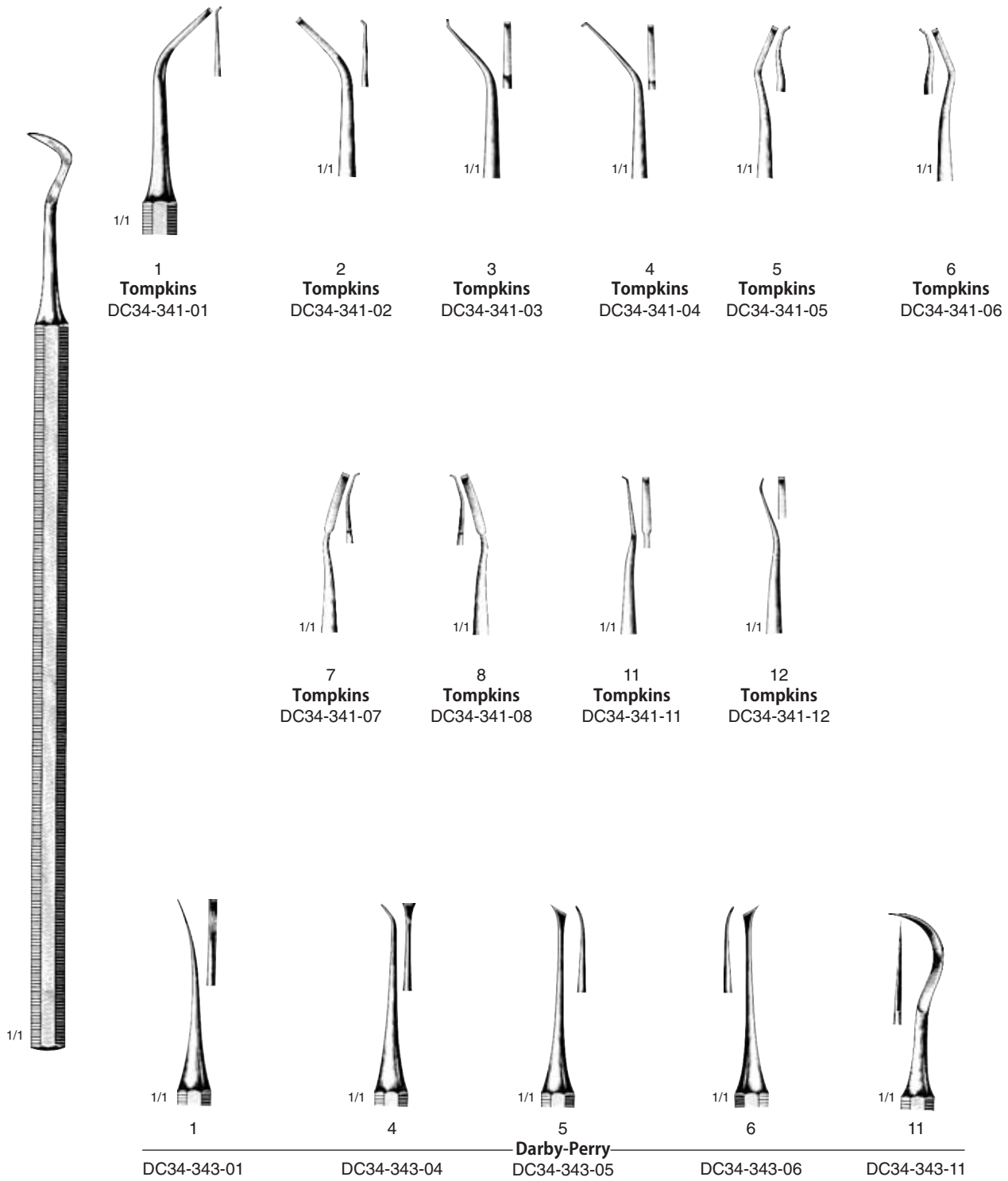

DC34-341-01 DC34-343-11 Pyorrhea Instruments

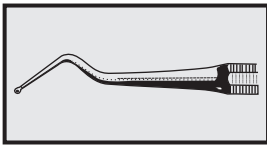

Scalers

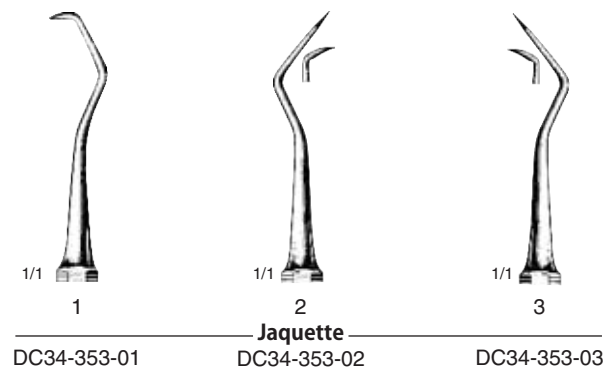
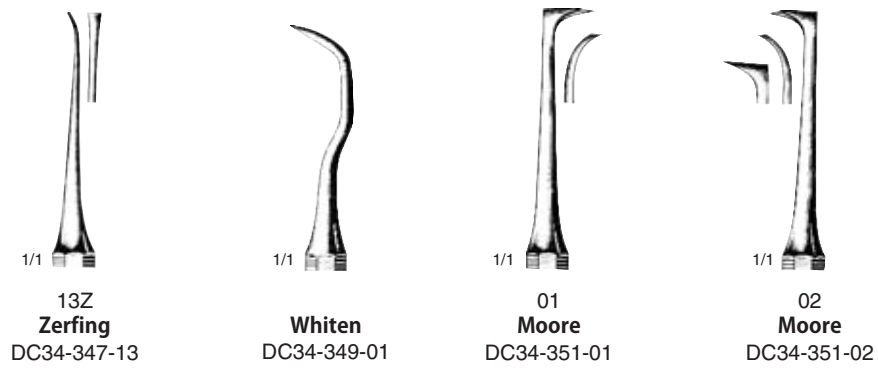
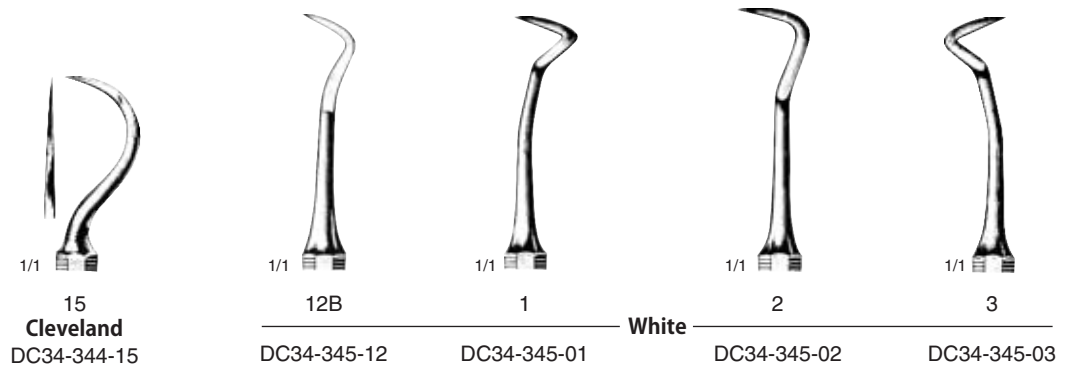
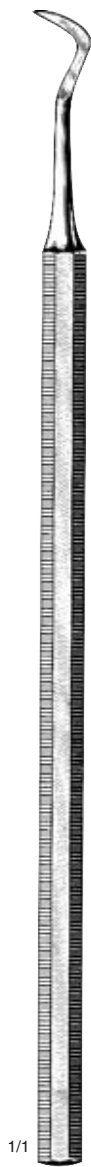

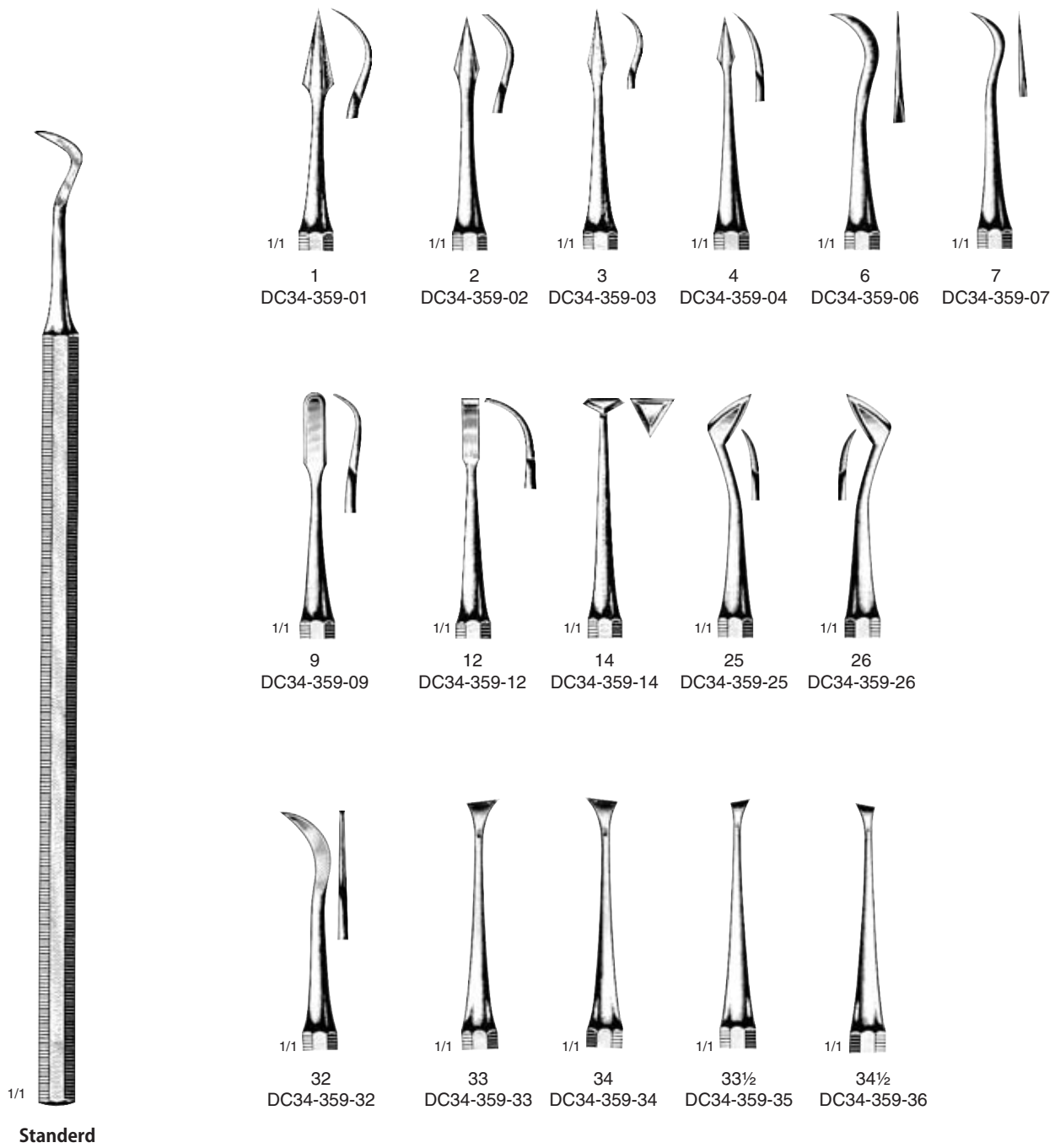
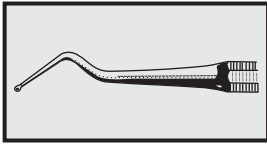

Standard

- 1/1
1
DC34-359-01
- 1/1
2
DC34-359-02
- 1/1
3
DC34-359-03
- 1/1
4
DC34-359-04
- 1/1
6
DC34-359-06
- 1/1
7
DC34-359-07

- 1/1
9
DC34-359-09
- 1/1
12
DC34-359-12
- 1/1
14
DC34-359-14
- 1/1
25
DC34-359-25
- 1/1
26
DC34-359-26

- 1/1
32
DC34-359-32
- 1/1
33
DC34-359-33
- 1/1
34
DC34-359-34
- 1/1
33½
DC34-359-35
- 1/1
34½
DC34-359-36

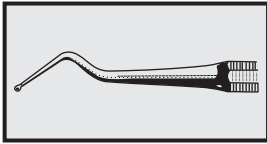

Scalers

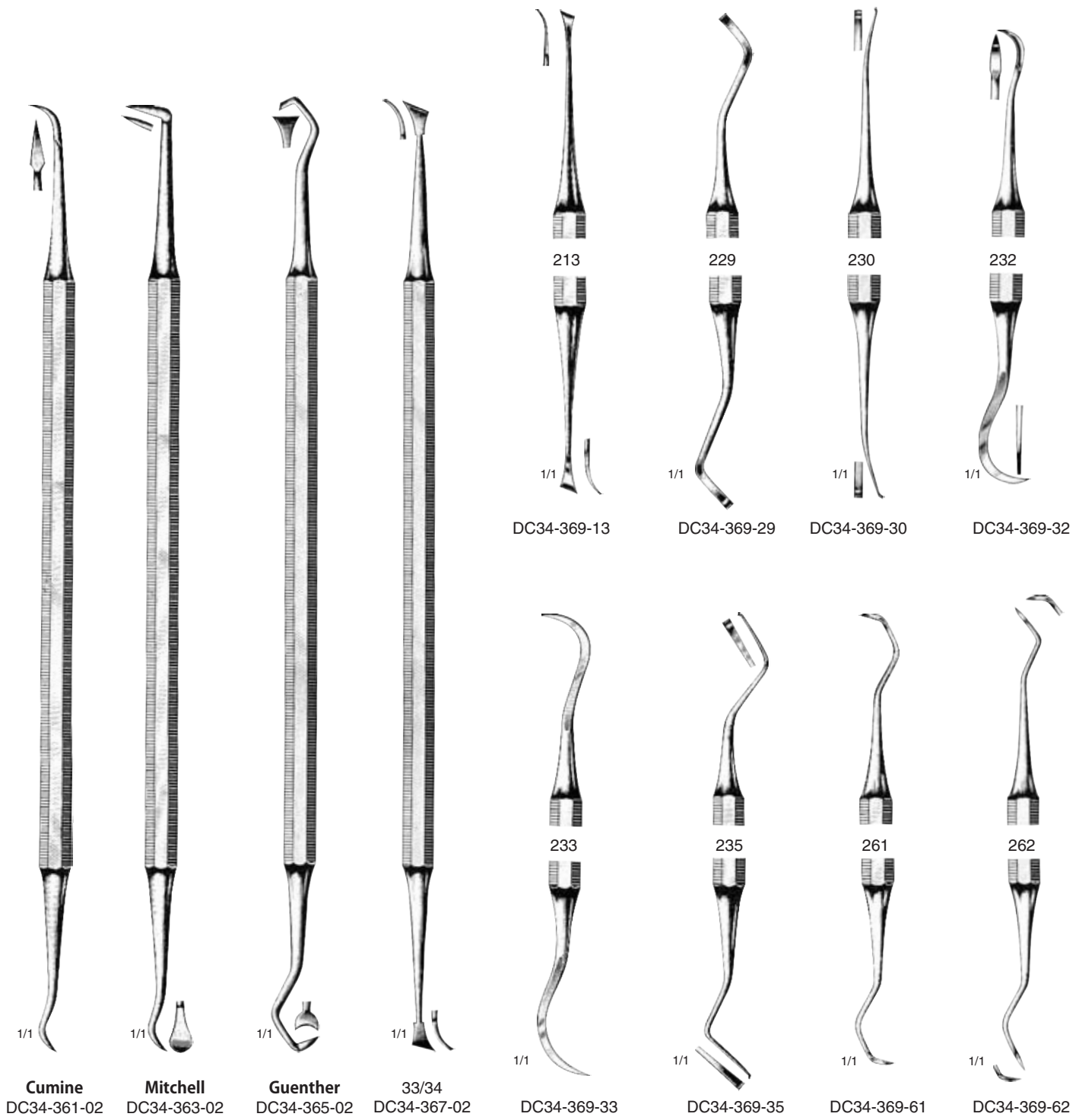

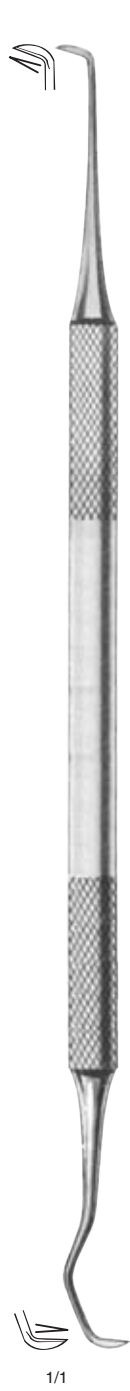
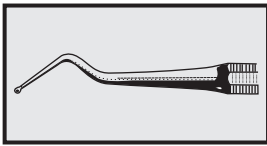

1/1

DC34-371-01



1/1

DC34-371-02



1/1

DC34-371-03



1/1

DC34-371-04

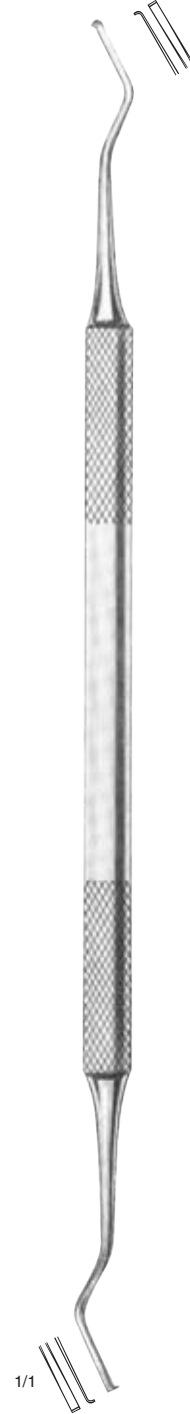

1/1

DC34-371-05



1/1

DC34-371-06

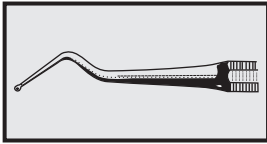

Periodonita Instruments

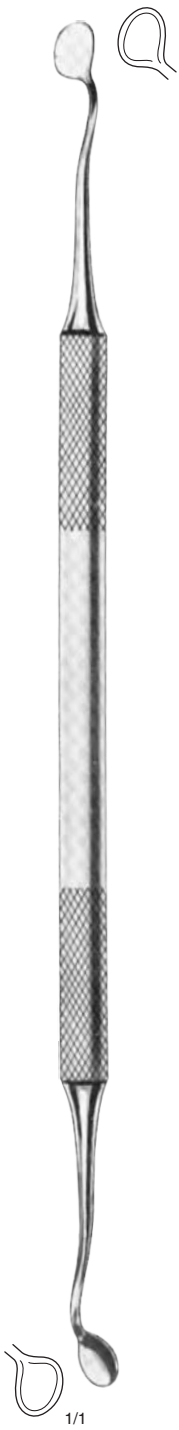

DC34-371-07



DC34-371-08



DC34-371-09



DC34-371-10

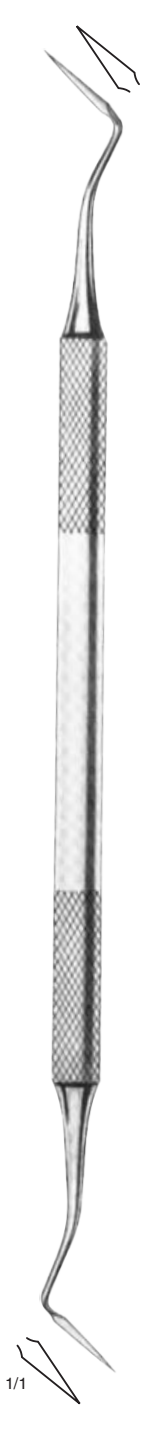

DC34-371-11



DC34-371-12

DC34-371-07	DC34-371-11	Gingivectomy Knives
	DC34-371-12	Scaler, double-ended

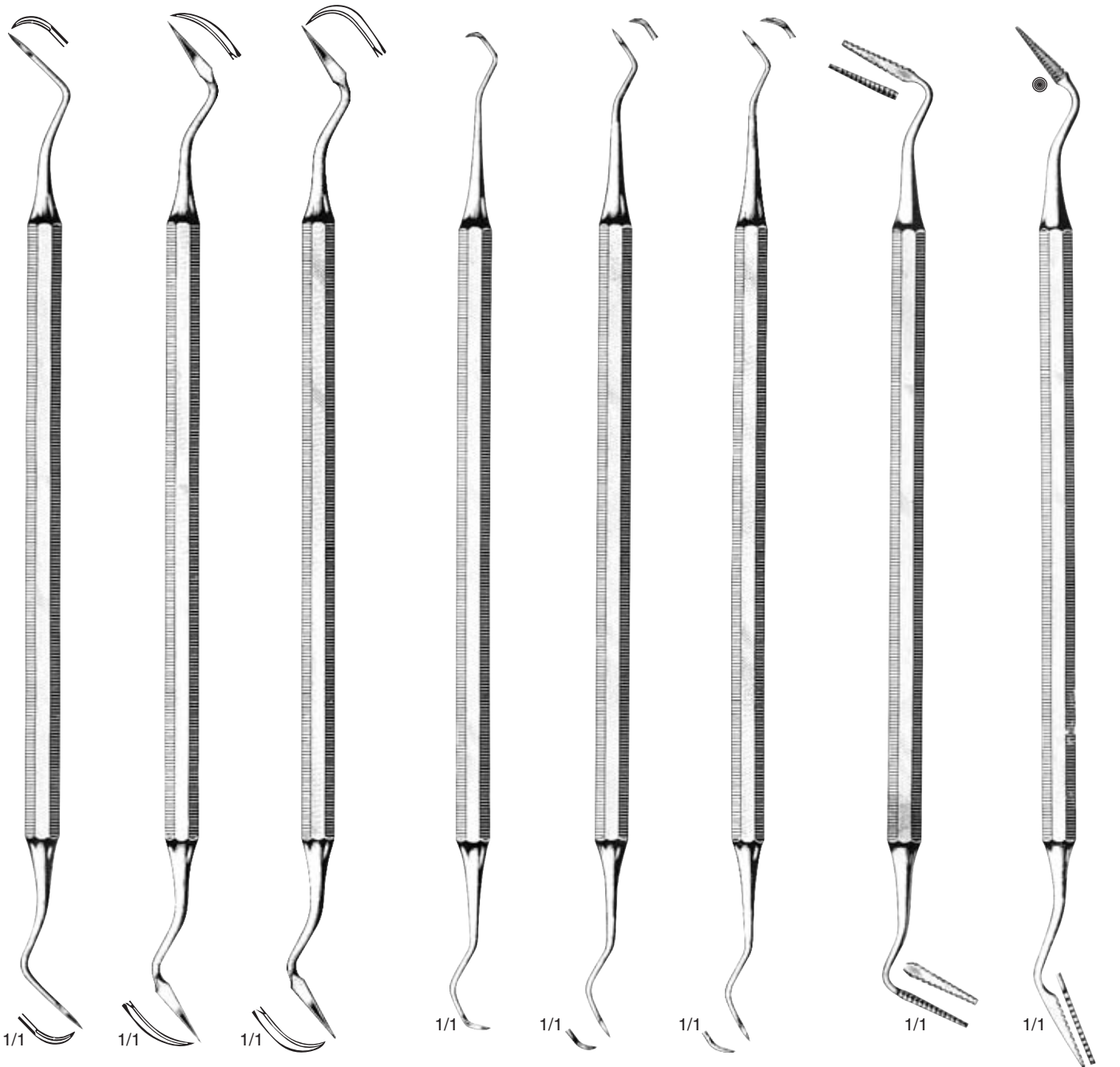
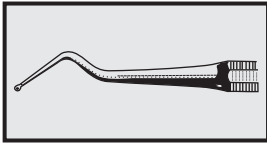

DC34-373-01 DC34-373-02 DC34-373-03 DC34-375-01 **Jaquette** DC34-375-02 DC34-375-03 **Buck** DC34-377-01 **Sanders** DC34-379-01

DC34-373-01	DC34-375-03	Scalers double-ended
DC34-377-01	DC34-379-01	Interproximal Trimmrs

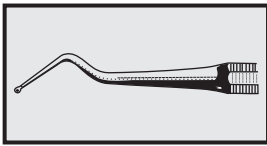

Periodonita Instruments

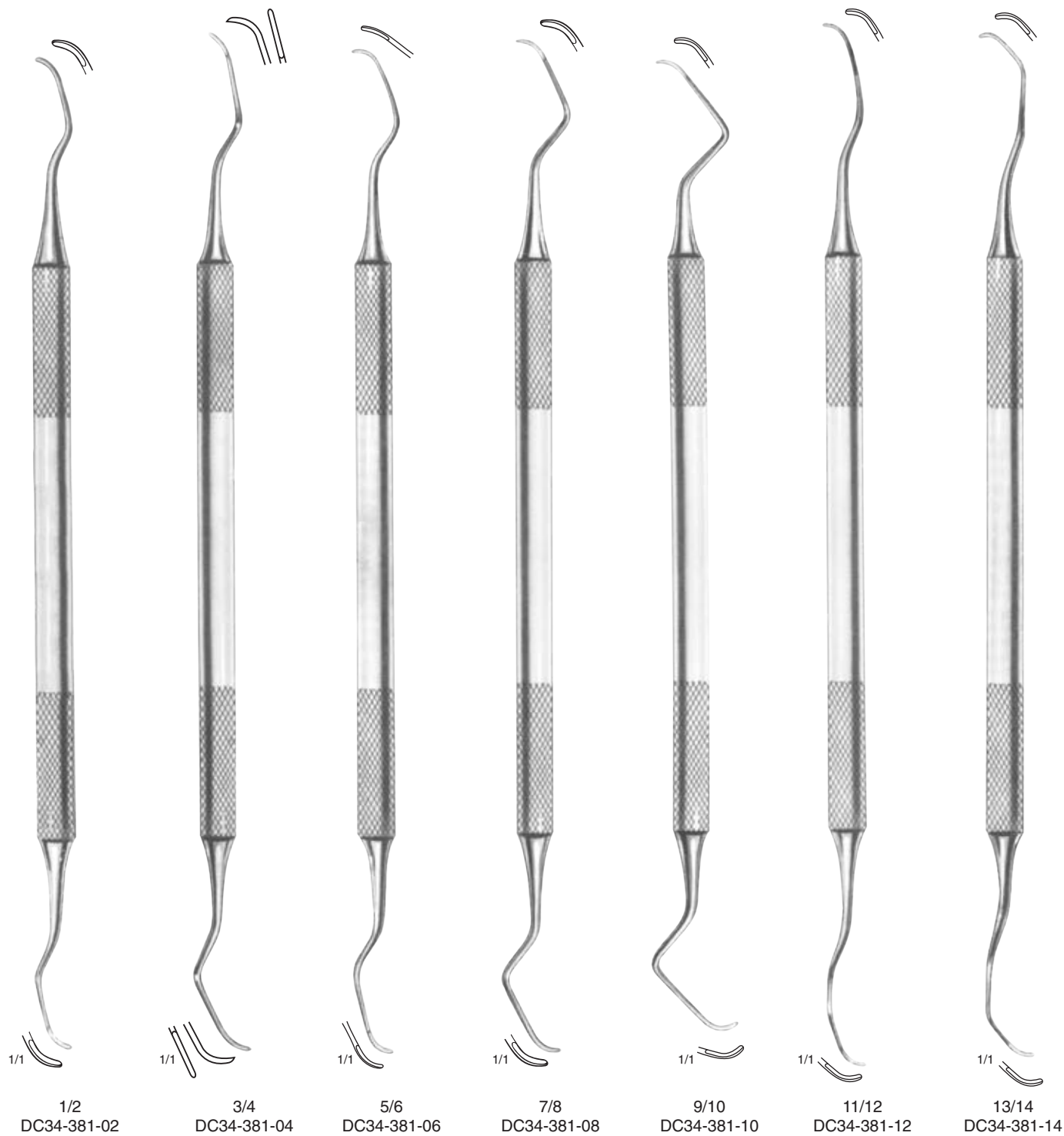

DC34-381-02 DC34-381-14 Scalers

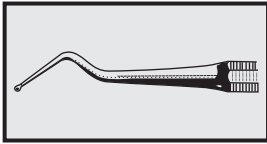

Special Instruments for Periodontosis and Pyorrhea.

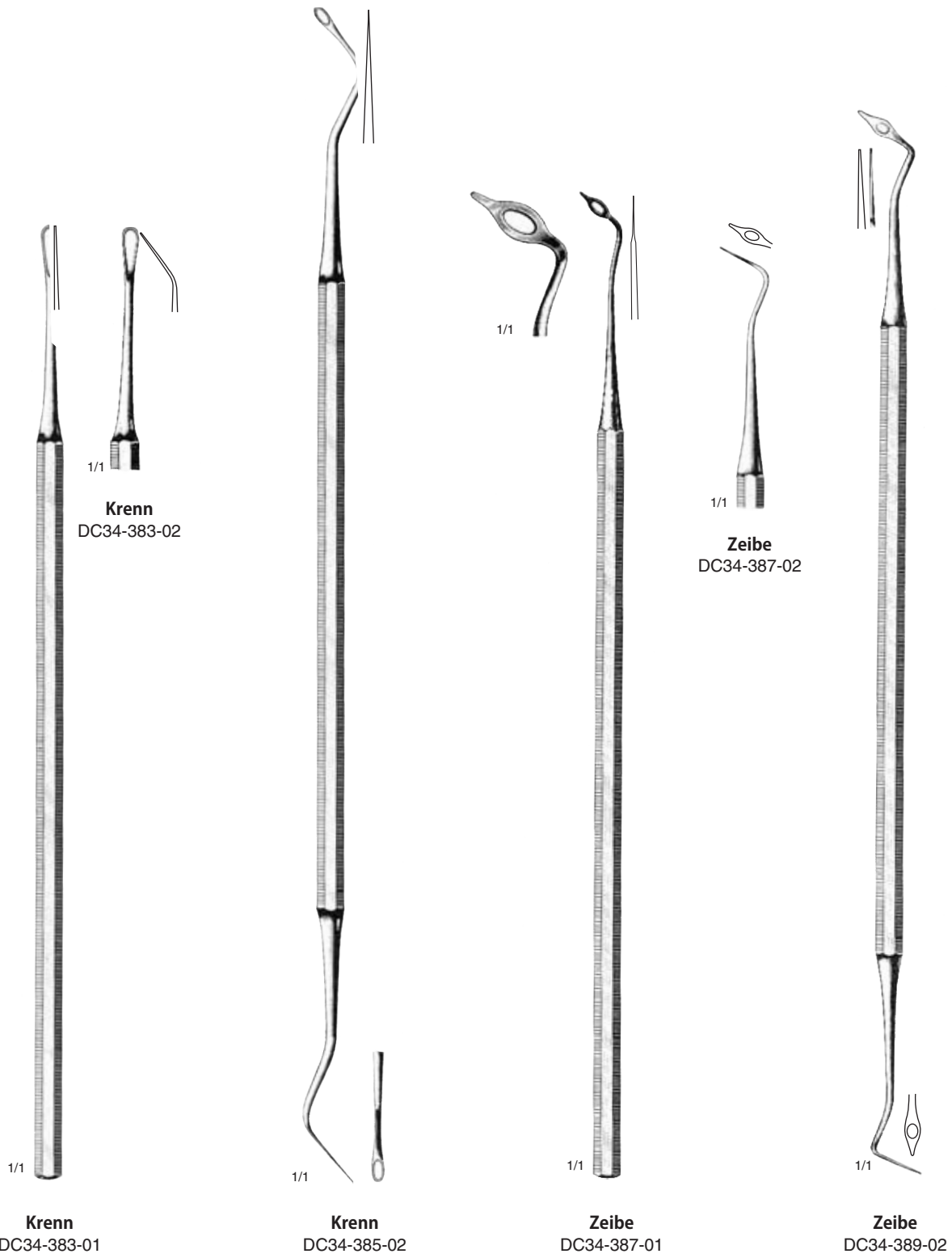

DC34-383-01	DC34-385-02	Loops
DC34-387-01	DC34-389-02	Gum Probes with Eye

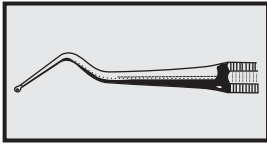

Instruments for Periodontitis Pyorrhea



Crane-Kaplan
DC27-173-30



Crane-Kaplan
DC27-175-30



DC34-393-01



DC34-395-01



DC34-395-02



Krenn
DC34-397-02

DC27-173-30	DC27-175-30	Pocket markers
DC34-393-01	DC34-397-02	Probes for measuring gum pockets

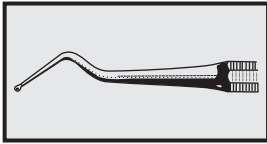

Scalers

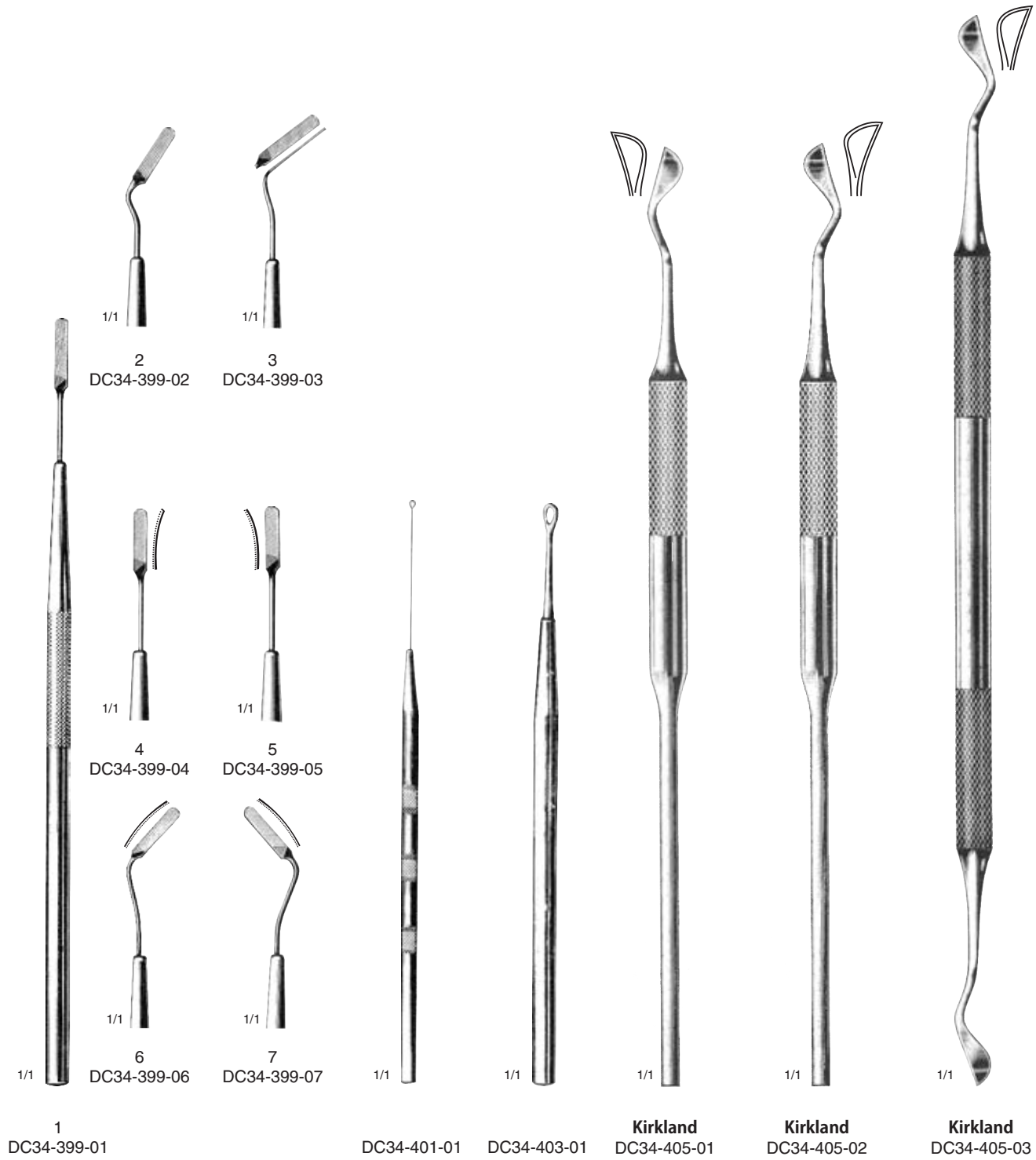

DC34-399-01	DC34-399-07	Finishing Files
DC34-401-01	DC34-403-01	Loops
DC34-405-01	DC34-405-03	Gingivectomy Knives

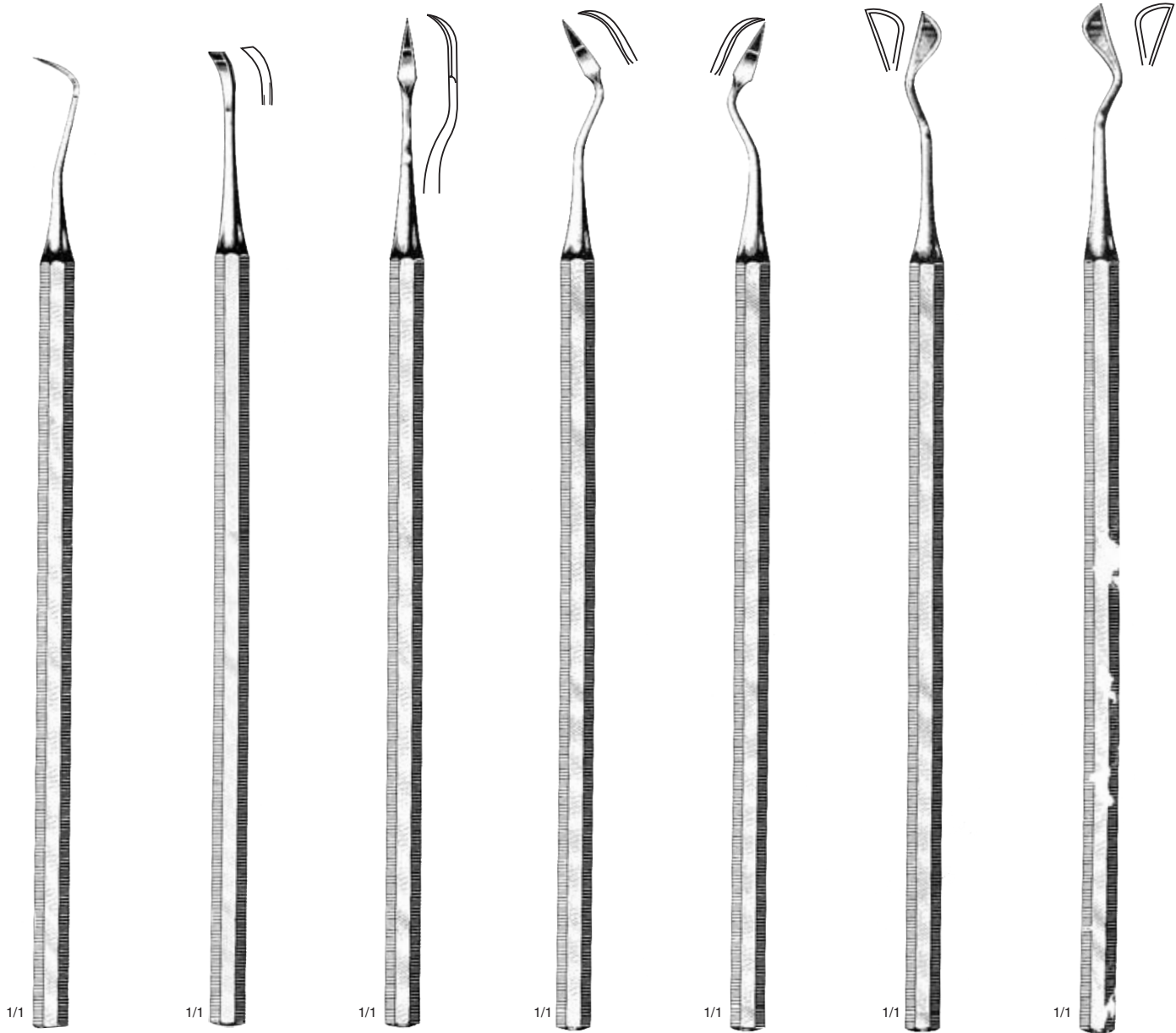
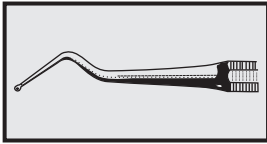

1/1

1/1

1/1

1/1

1/1

1/1

1/1

Mercitan

DC34-407-01

DC34-407-02

Ward-Kirkland

DC34-409-01

DC34-409-02

DC34-409-03

DC34-409-04

DC34-409-05

DC34-407-01 DC34-409-05 Scalers, Single-ended

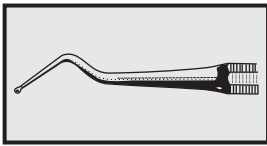

Chisels & Enamel Cleavers

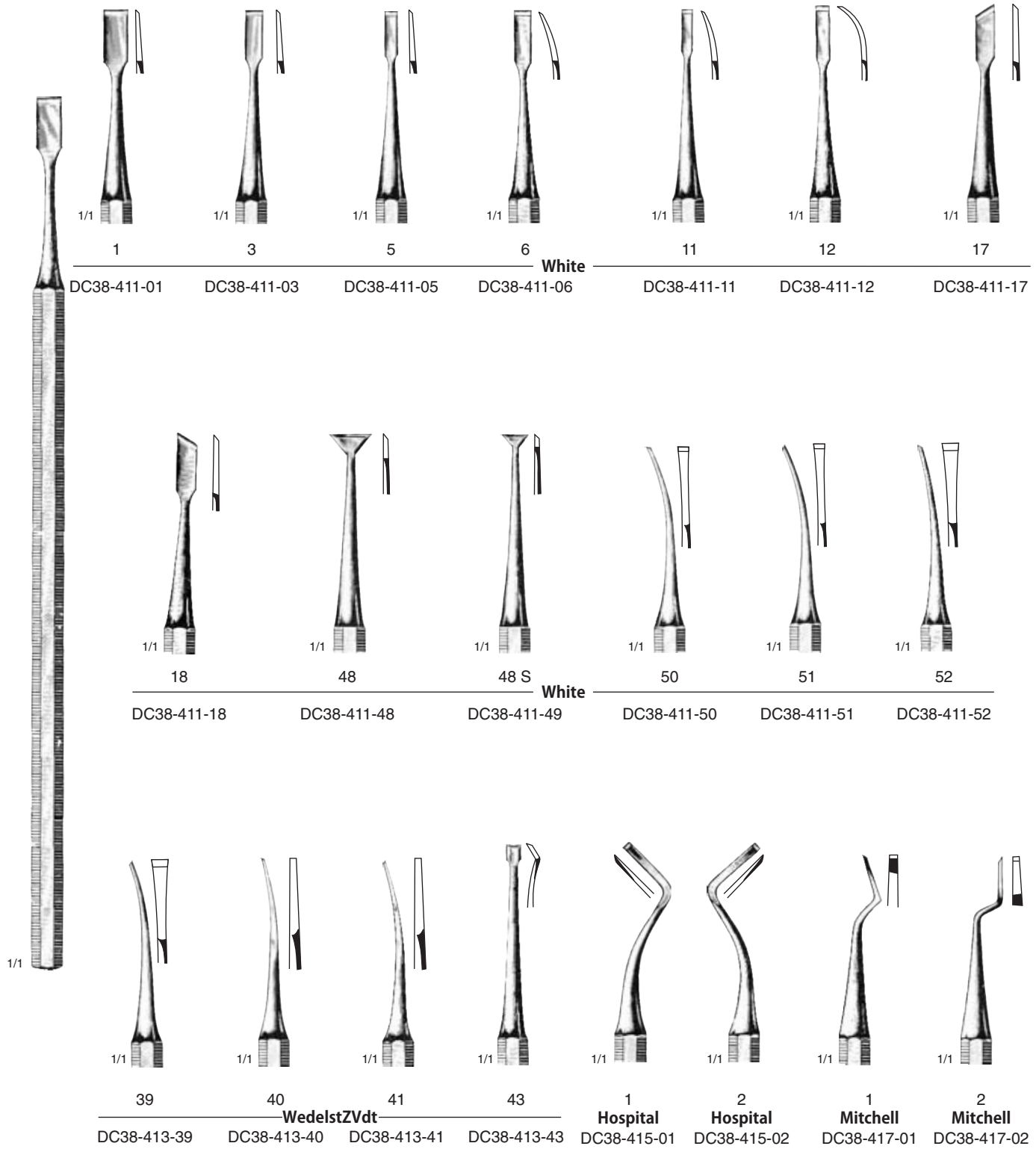

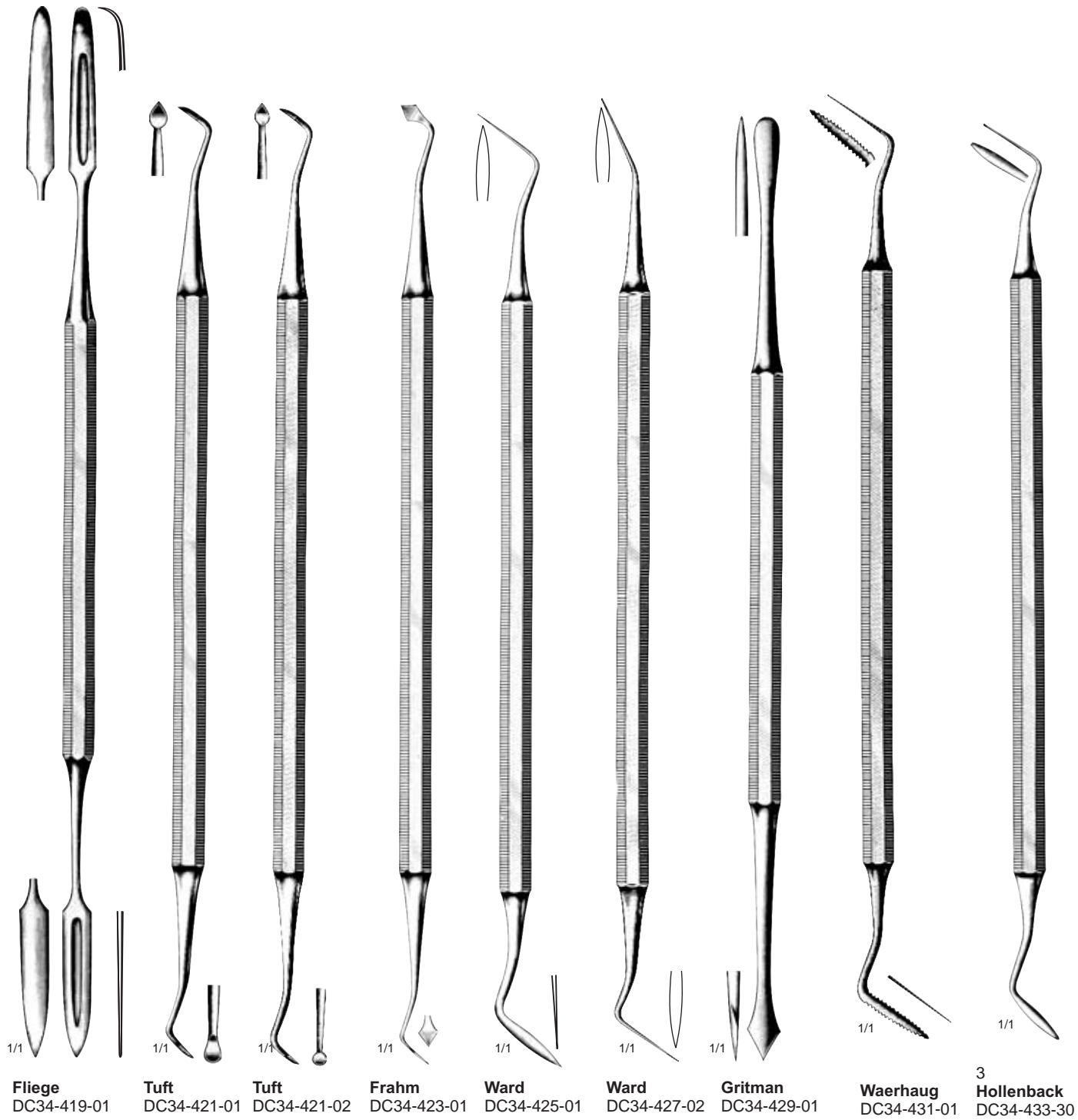
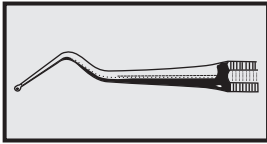

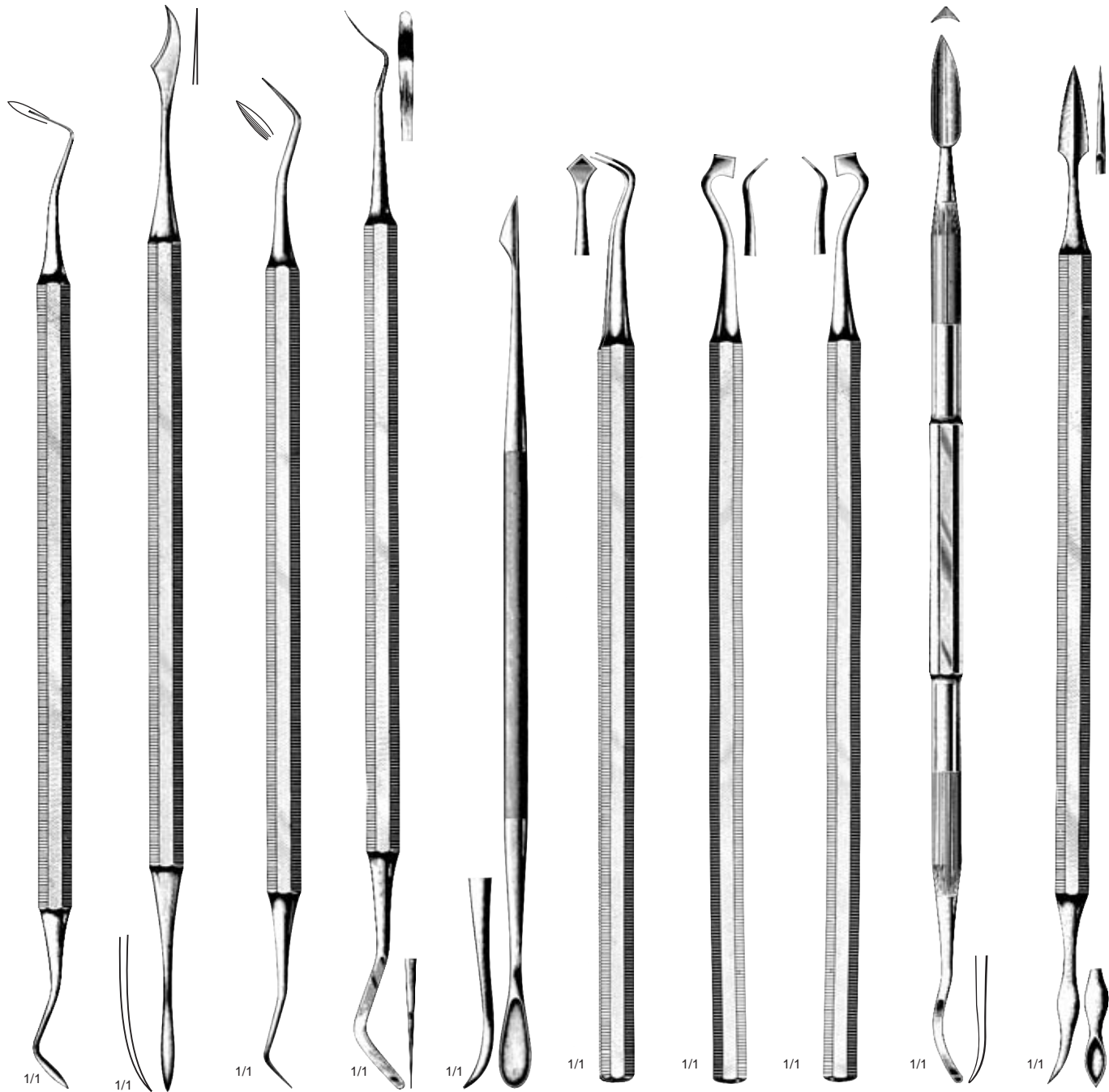
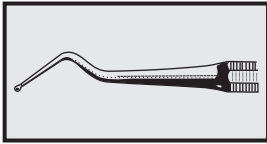

3S
Hollenback
DC34-435-31

No. 5
DC34-437-01

Shooshan
DC34-439-01

DC34-441-01

DC34-443-01

1
Frahm
DC34-445-01

2
Frahm
DC34-445-02

3
Frahm
DC34-445-03

DC34-447-01

Roach
DC34-449-01

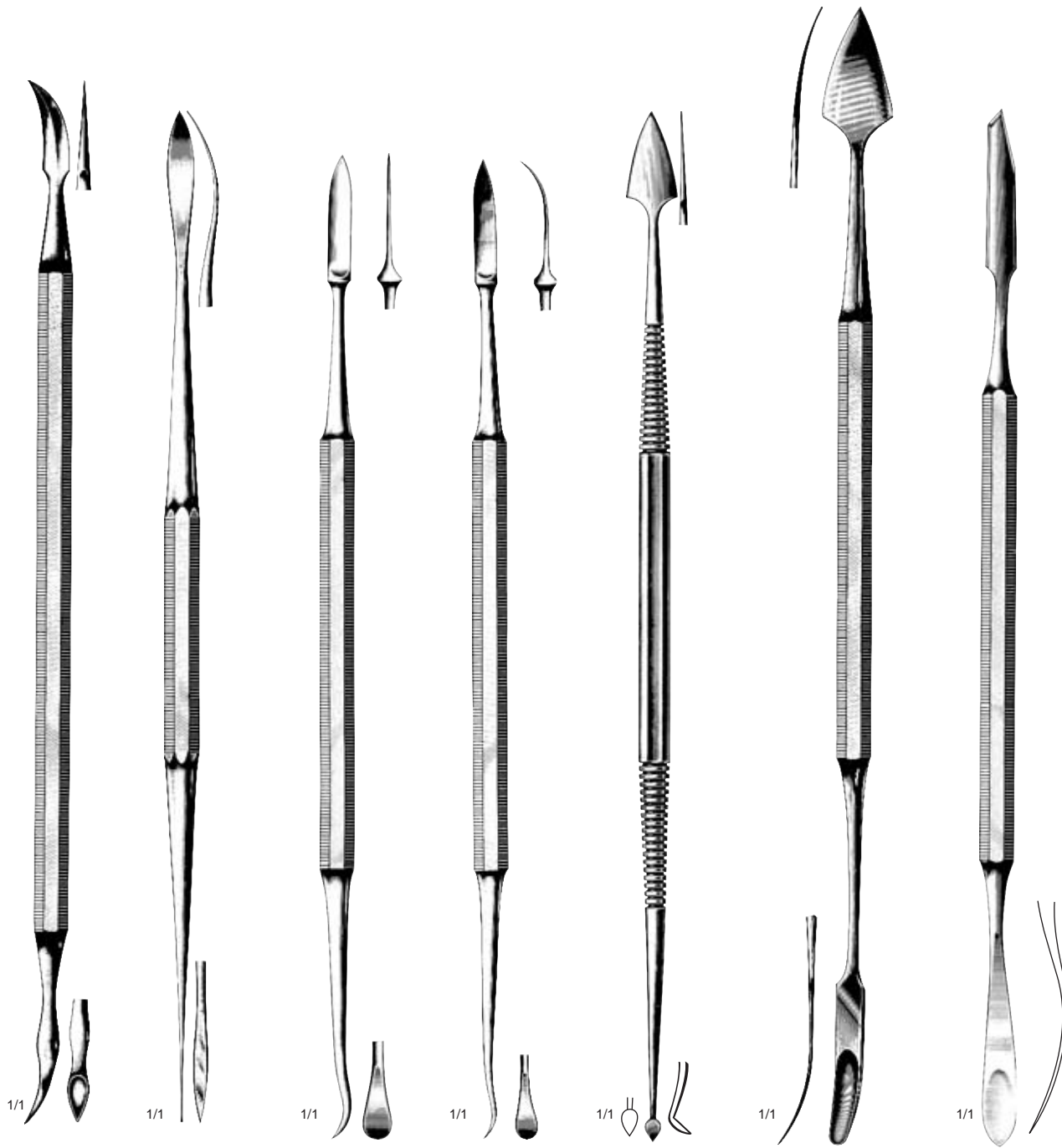
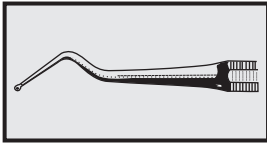

Roach
DC34-451-02

Riegner
DC34-453-01

Evans
DC34-455-01

Evans
DC34-457-01

Vehe
DC34-459-01

Wolff
DC34-461-01

Fjeldstad
DC34-463-01

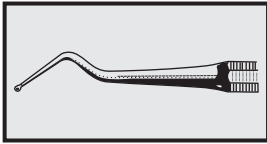

Acker
DC34-465-01



Falck
DC34-467-01

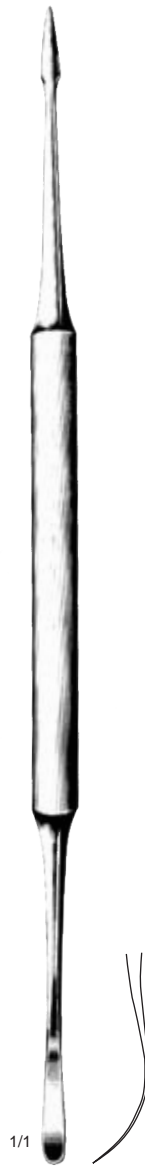

Falck
DC34-469-01



Beale
DC34-471-01



Ermert
DC34-473-01



Ermert
DC34-475-01



Gisy-Wild
15 cm / 6"
DC34-477-15

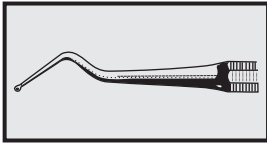

Wax Spatula, Wax Knives, Wax Spoons

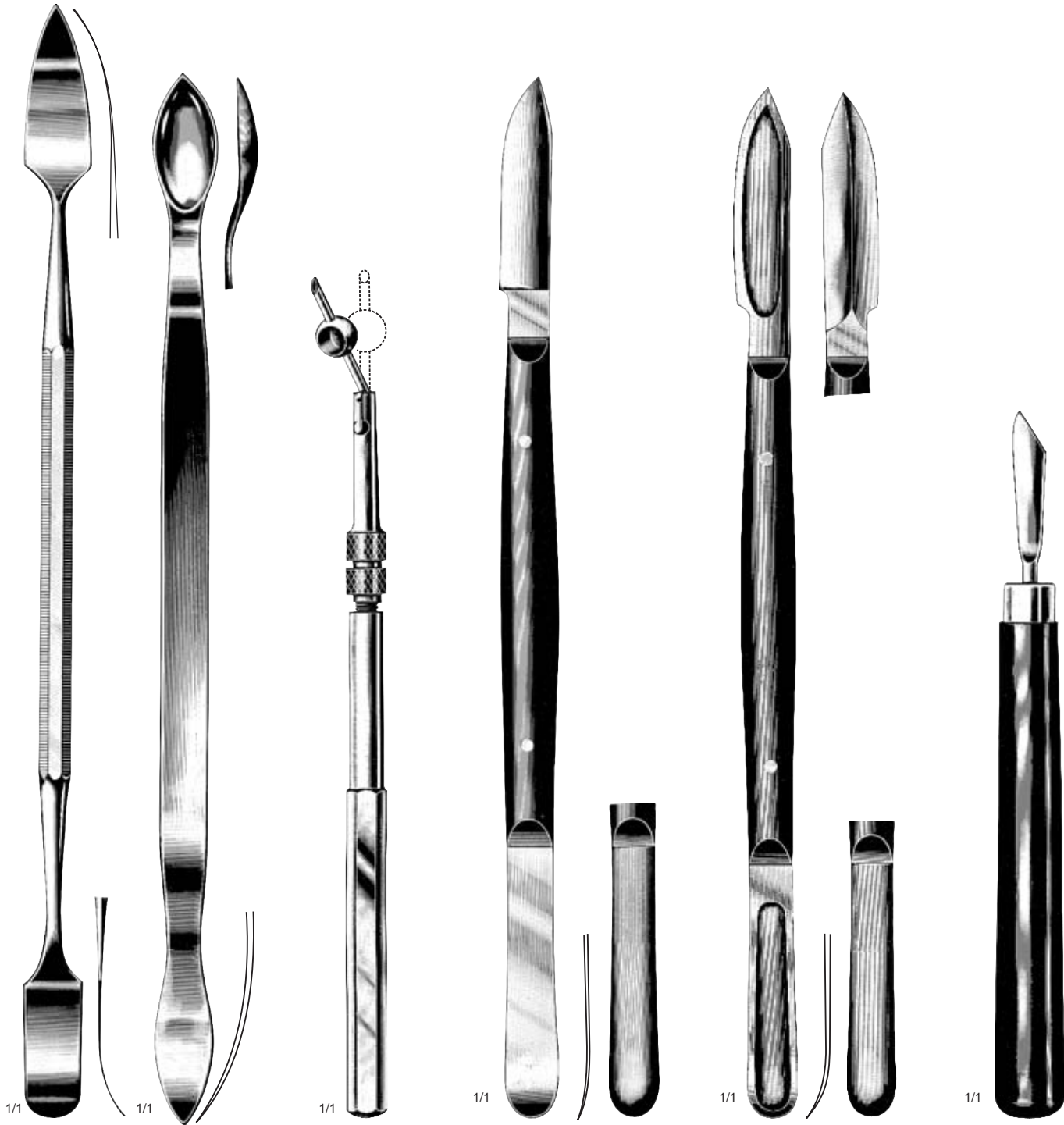

Gritman
DC34-479-01

Gritman
DC34-481-01

Cerafix
DC34-483-01

Fahnenstock
13 cm / 5"
DC34-485-13

Fahnenstock
17 cm / 6 3/4"
DC34-485-17

Lessmann
13 cm / 5"
DC34-487-13

Lessmann
17 cm / 7"
DC34-487-17

Antkoviak
12.5 cm / 5"
DC34-489-12

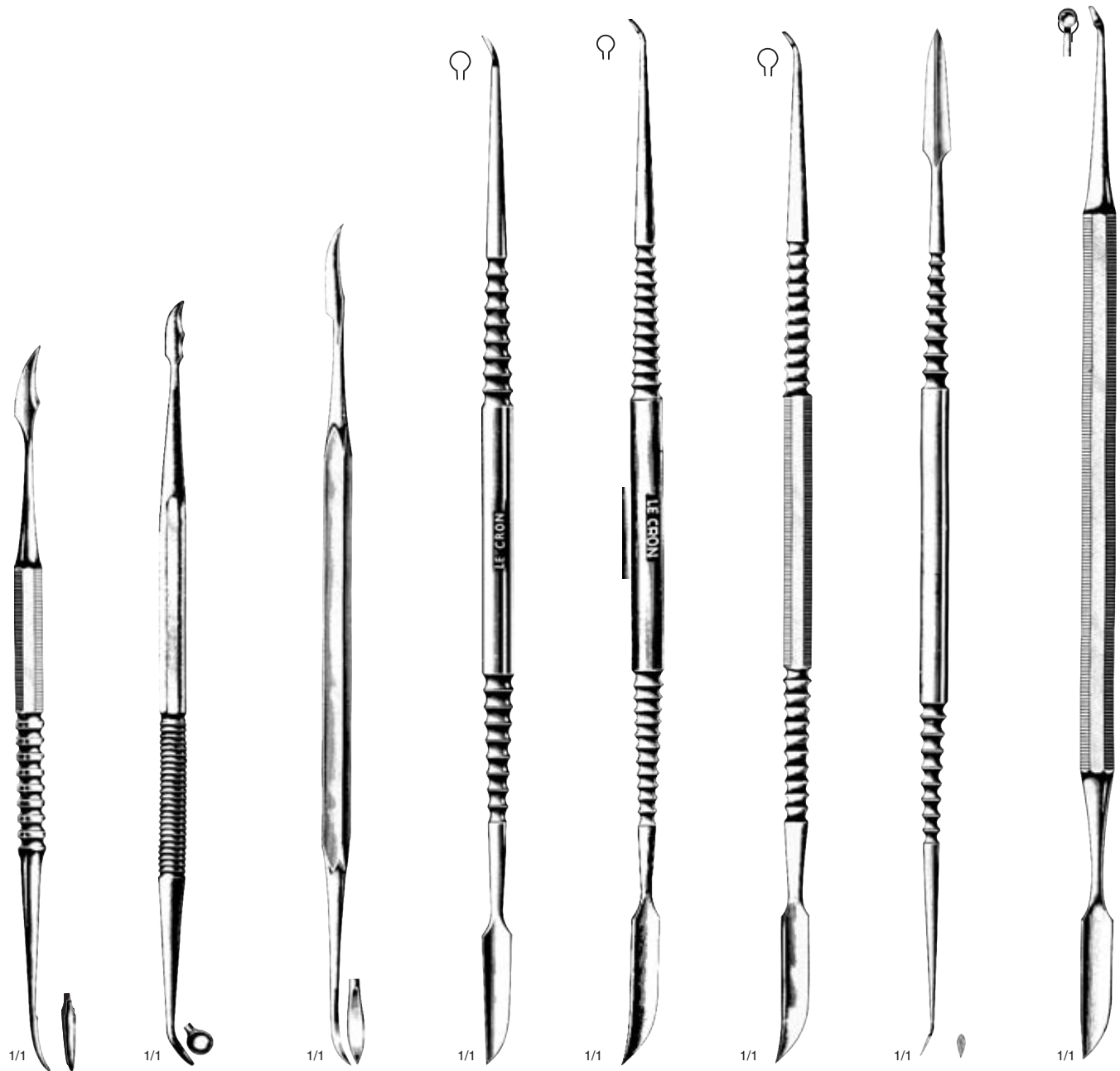
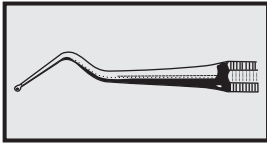

Zahle
DC34-491-01

Hylin
DC34-493-01

Zahle
DC34-495-01

Le Cron
DC34-497-01

Le Cron
DC34-499-01

Le Cron
DC34-501-01

DC34-503-01

DC34-505-01

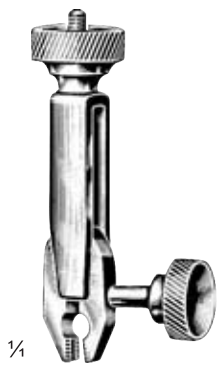
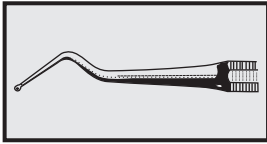

1/4

Ivory
DC34-510-01
Post Puller



Miller
DC34-517-15
15 cm/6"
Forceps for Articulating
Paper

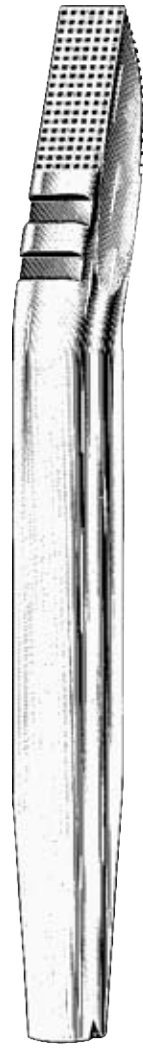

Sachs
DC34-520-01
Plexiglas

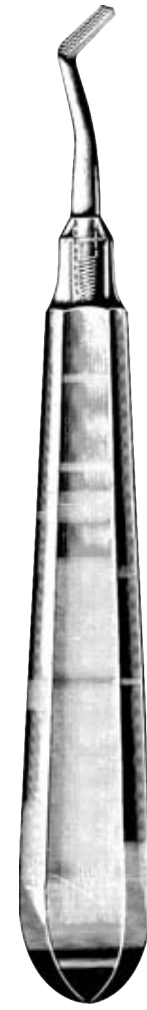

DC34-524-00

— Mershon-Young —



Fig. 1
DC34-525-01



Fig. 2
DC34-525-02



Fig. 3
DC34-525-03

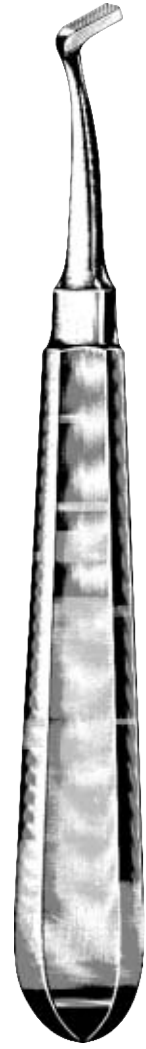

Mershon
DC34-528-01
Band Pusher
or Setter

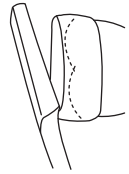
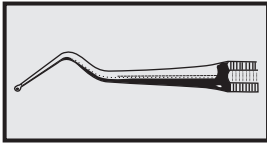

Swivel Lid for removing pins easily

$\frac{2}{3}$

DC34-555-00
55 mm Ø 17 mm



$\frac{1}{4}$

DC34-530-01



Steiner
DC34-532-01



Mod. Paris
DC34-5DC34-01

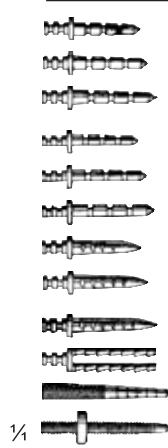

$\frac{1}{4}$

Fig.

1	DC34-552-01
2	DC34-552-02
3	DC34-552-03
4	DC34-552-04
5	DC34-552-05
6	DC34-552-06
7	DC34-552-07
8	DC34-552-08
9	DC34-552-09
10	DC34-552-10
14	DC34-552-14
15	DC34-552-15



DC34-540-01



DC34-549-30
10 m/32 ft. 10 in. x 0.3 mm Ø

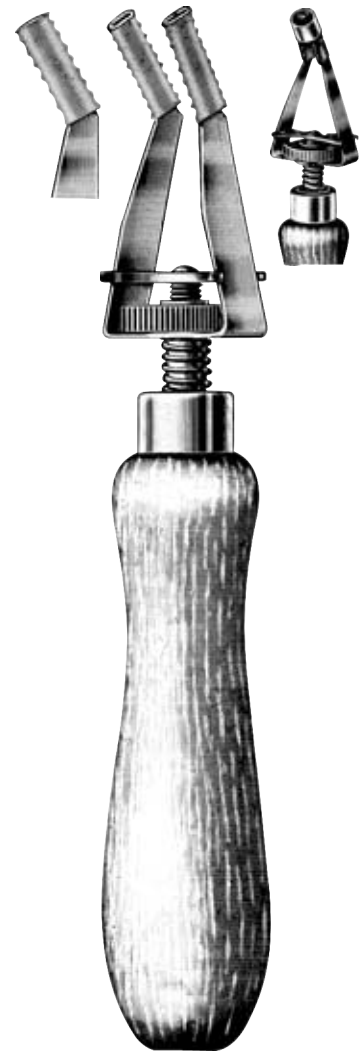

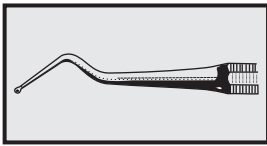

Instruments for Crown Work,
Vulcanite Scrapers



3/8
Fig. 1

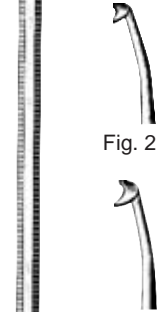

Fig. 2

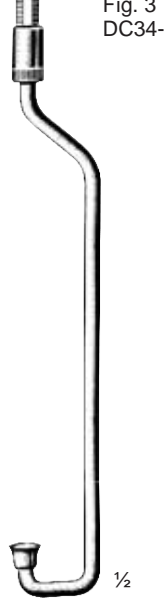
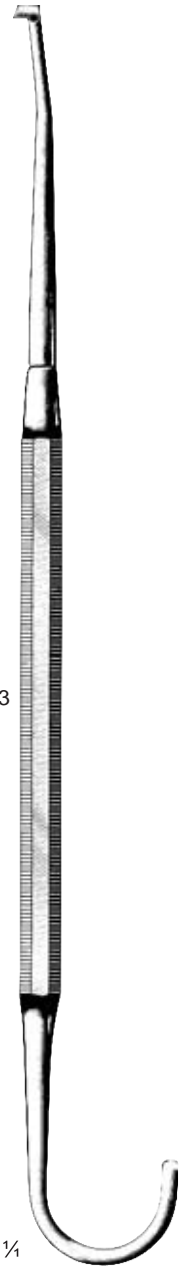
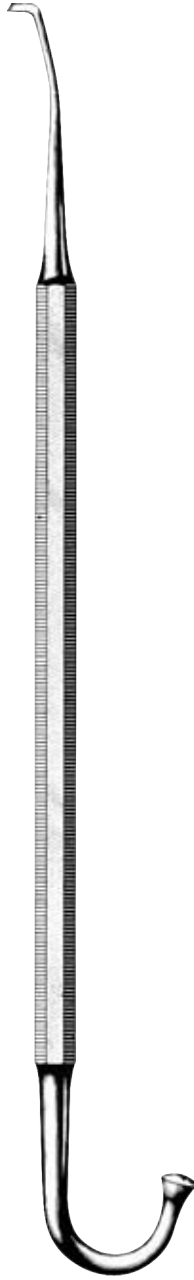

Fig. 3
DC34-574-03

Schroeder
DC34-573-00
DC34-573-01
DC34-574-03



Krumnow
DC34-575-00
DC34-575-01
DC34-574-03



Treyman
DC34-578-01



Miller
DC34-580-01

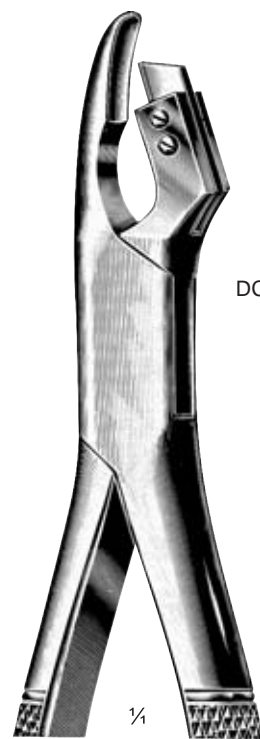

Monfort
DC34-590-19
19 cm/7 1/2"



Mitchell
DC34-601-01



Williams
Fig. 1
DC34-602-01



Williams
Fig. 2
DC34-602-02



DC34-591-01

11

MAZAS, ESCAVADORES DE HUESOS.

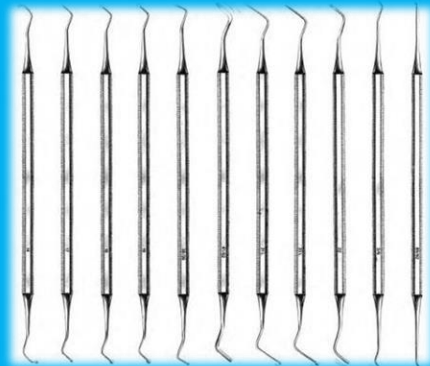

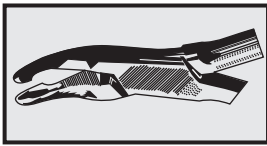

Mallets

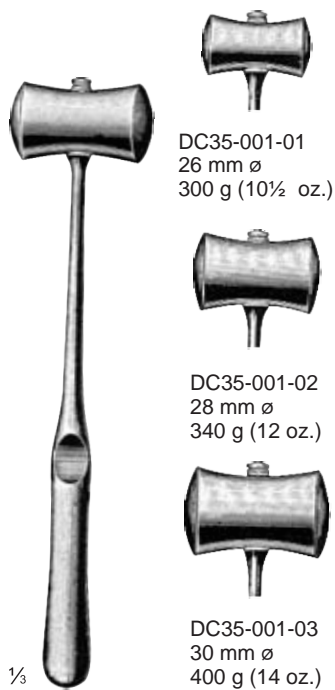

DC35-001-01
26 mm ø
300 g (10½ oz.)

DC35-001-02
28 mm ø
340 g (12 oz.)

DC35-001-03
30 mm ø
400 g (14 oz.)

Williger
24 cm / 9½"
lead filled

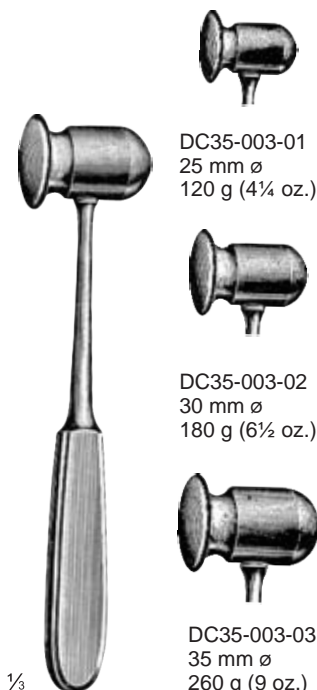

DC35-003-01
25 mm ø
120 g (4¼ oz.)

DC35-003-02
30 mm ø
180 g (6½ oz.)

DC35-003-03
35 mm ø
260 g (9 oz.)

Doyen
21 cm / 8¼"
brass, solid

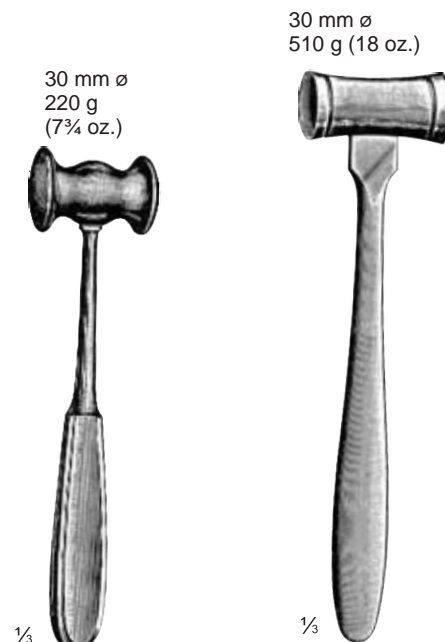

30 mm ø
220 g
(7¾ oz.)

30 mm ø
510 g (18 oz.)

Collin
DC35-005-20
20 cm / 8"
brass, solid

DC35-007-22
22.5 cm / 9"
steel, solid



26 mm ø
320 g (11¼ oz.)

Mead
DC35-009-17
17 cm / 6¾"
solid
DC35-009-00
Ferrozell Cheeks
only, pair
with interchangeable
Ferrozell Cheeks



20 mm ø
140 g
(5 oz.)

DC35-011-01
lead filled
DC35-011-02
brass, solid
16.5 cm / 6½"

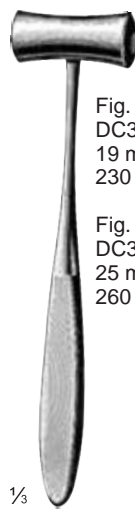
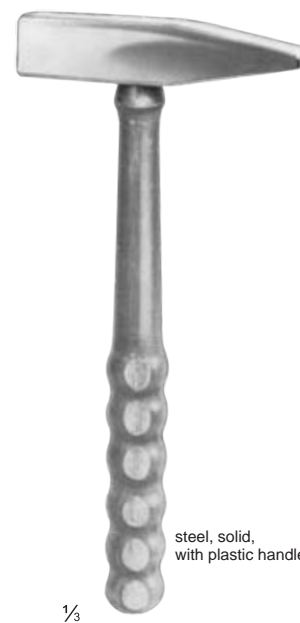

Fig. 1
DC35-013-01
19 mm ø
230 g (8 oz.)

Fig. 2
DC35-013-02
25 mm ø
260 g (9 oz.)

Lucae
19 cm / 7½"
brass, solid



steel, solid,
with plastic handle

DC35-015-24
24 cm / 9½"

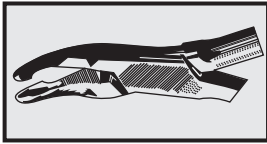

Bone Chisels and Gouges

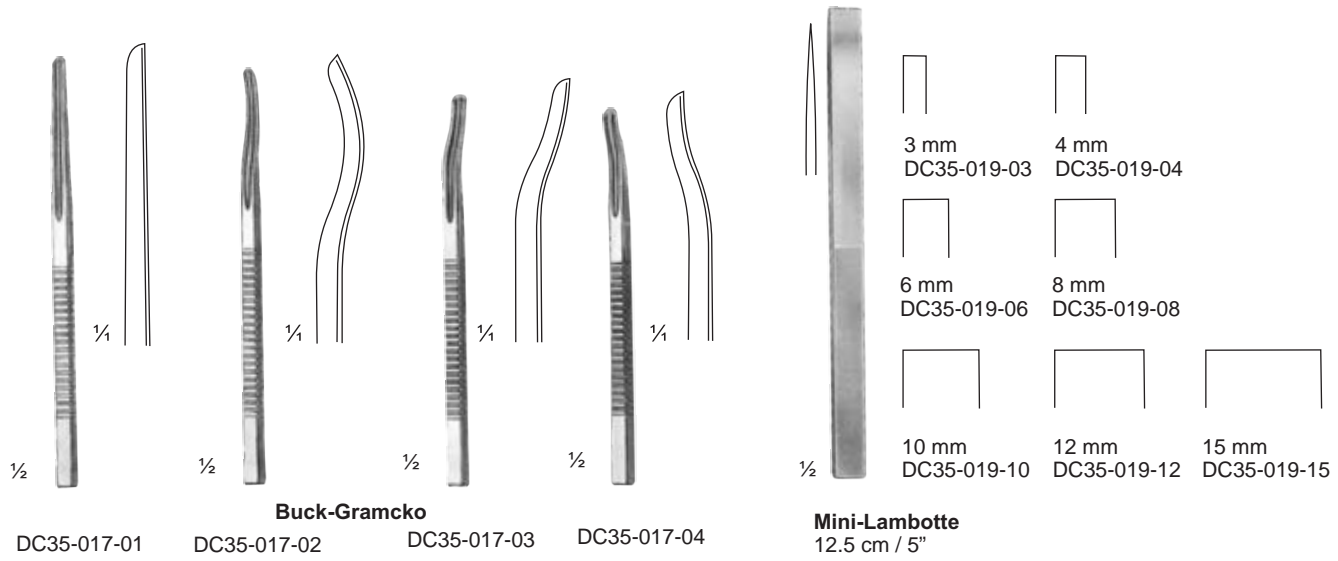

Partsch



Partsch

		width mm		
11.5 cm/4½"	13.5 cm/5¼"		11.5 cm/4½"	13.5 cm/5¼"
DC35-021-02	DC35-023-02	2	DC35-025-02	DC35-027-02
DC35-021-03	DC35-023-03	3	DC35-025-03	DC35-027-03
DC35-021-04	DC35-023-04	4	DC35-025-04	DC35-027-04
DC35-021-05	DC35-023-05	5	DC35-025-05	DC35-027-05
DC35-021-06	DC35-023-06	6	DC35-025-06	DC35-027-06
DC35-021-07	DC35-023-07	7	DC35-025-07	DC35-027-07
DC35-021-08	DC35-023-08	8	DC35-025-08	DC35-027-08

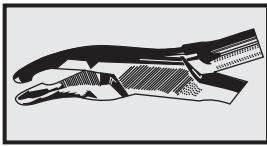

Bone Chisels and Gouges

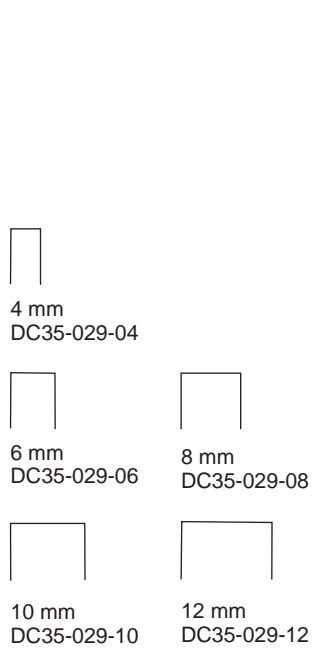

Mini-Lexer
18 cm / 7"

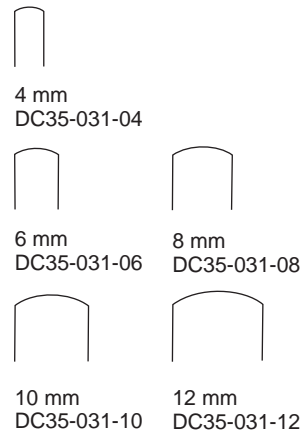

Mini-Lexer
18 cm / 7"

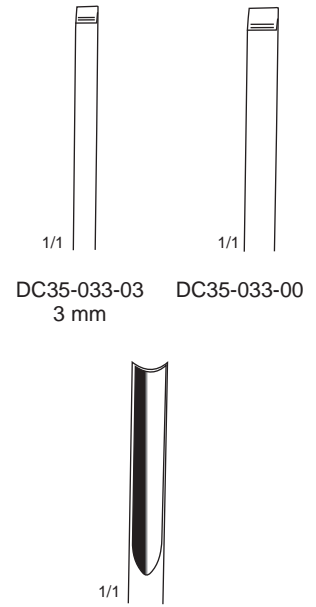

Buckley
14 cm / 6 1/2"

DC35-033-04
4 mm

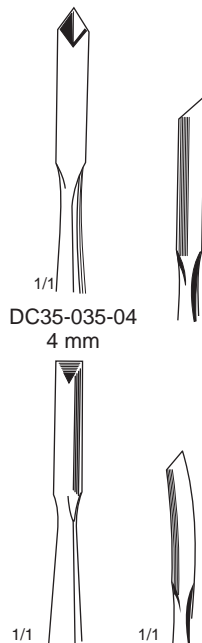

Gardner
17.5 cm / 7"

DC35-037-04
4 mm

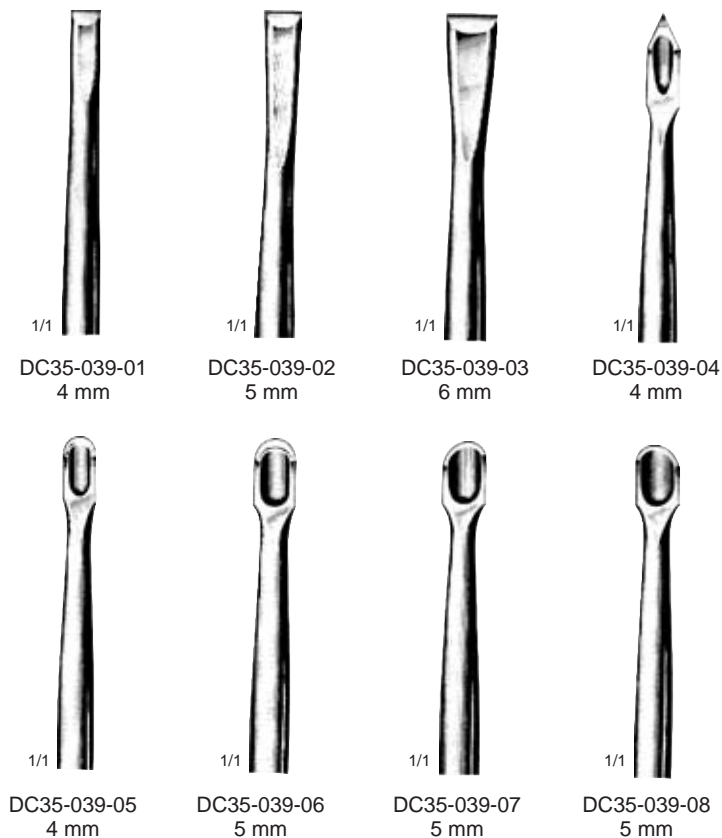

Walter F. Barry
21.5 cm / 9"

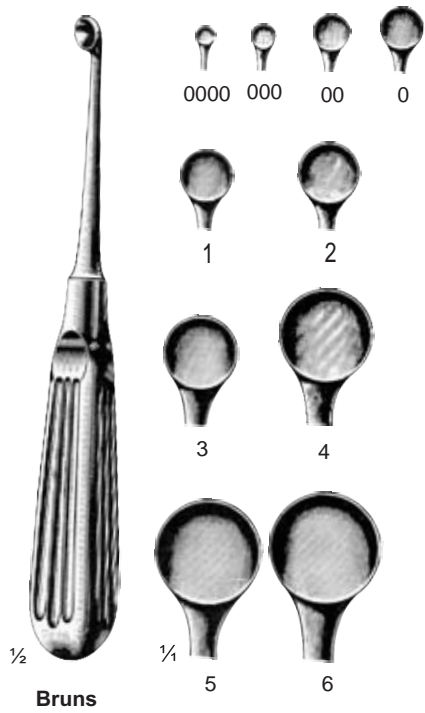
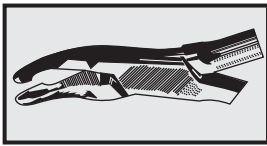

Bruns	Fig.
DC35-041-40	0000
DC35-041-30	000
DC35-041-20	00
DC35-041-10	0
DC35-043-01	1
DC35-043-02	2
DC35-043-03	3
DC35-043-04	4
DC35-043-05	5
DC35-043-06	6

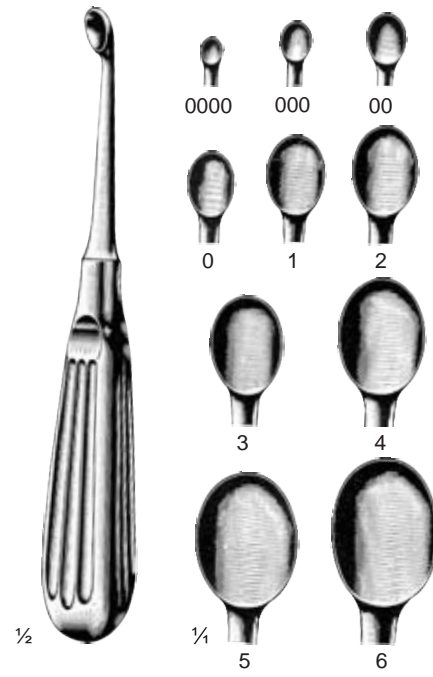

Volkmann	Fig.
DC35-045-40	0000
DC35-045-30	000
DC35-045-20	00
DC35-047-10	0
DC35-047-01	1
DC35-047-02	2
DC35-049-03	3
DC35-049-04	4
DC35-049-05	5
DC35-049-06	6

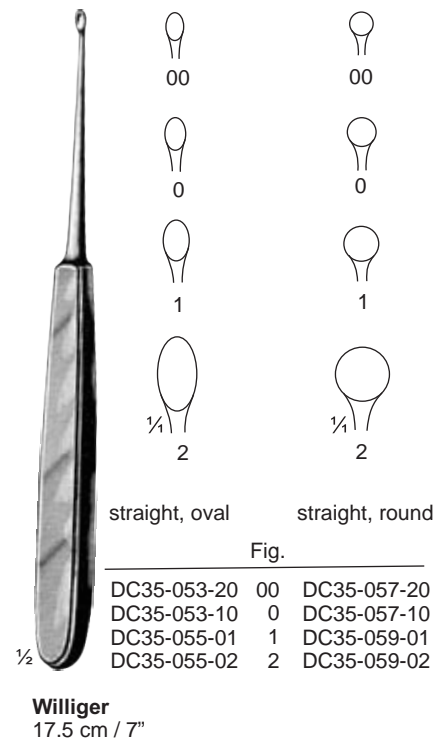
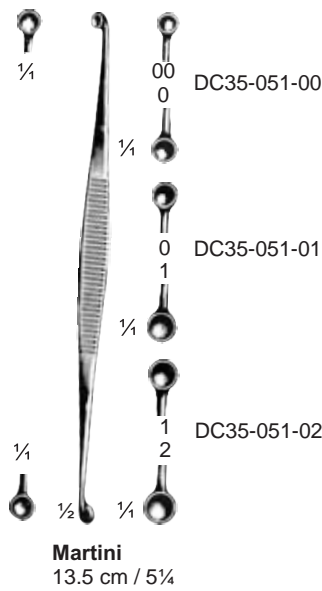
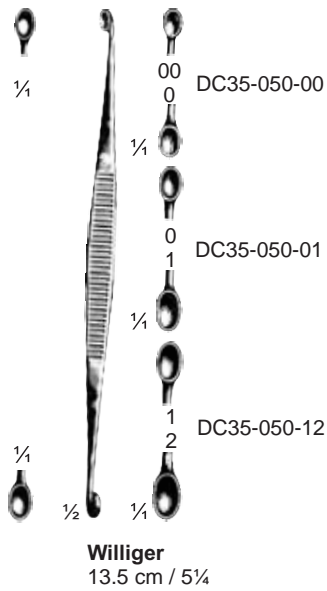

straight, oval	Fig.	straight, round
DC35-053-20	00	DC35-057-20
DC35-053-10	0	DC35-057-10
DC35-055-01	1	DC35-059-01
DC35-055-02	2	DC35-059-02

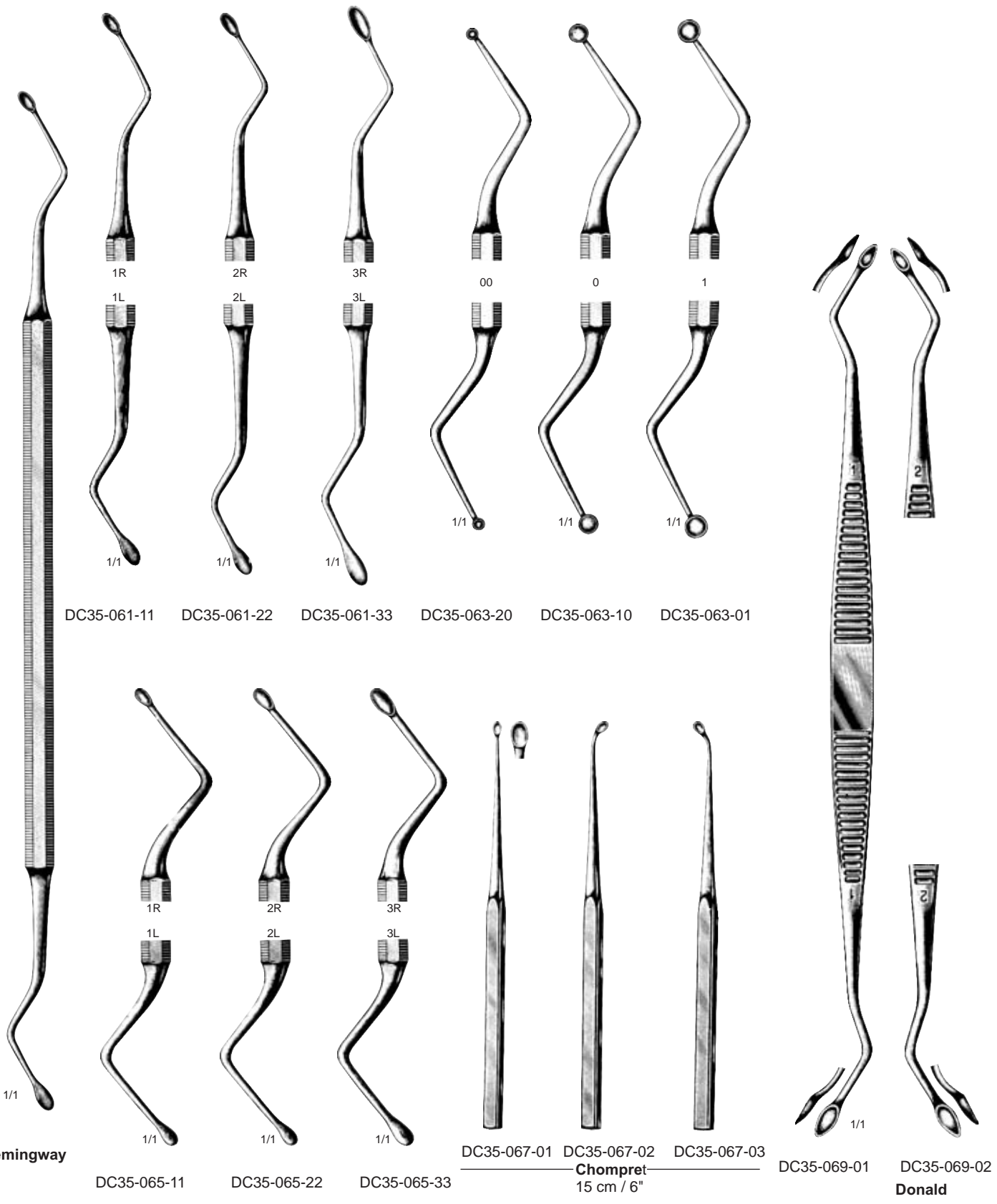
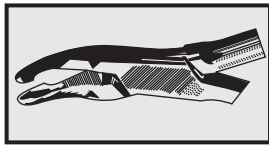

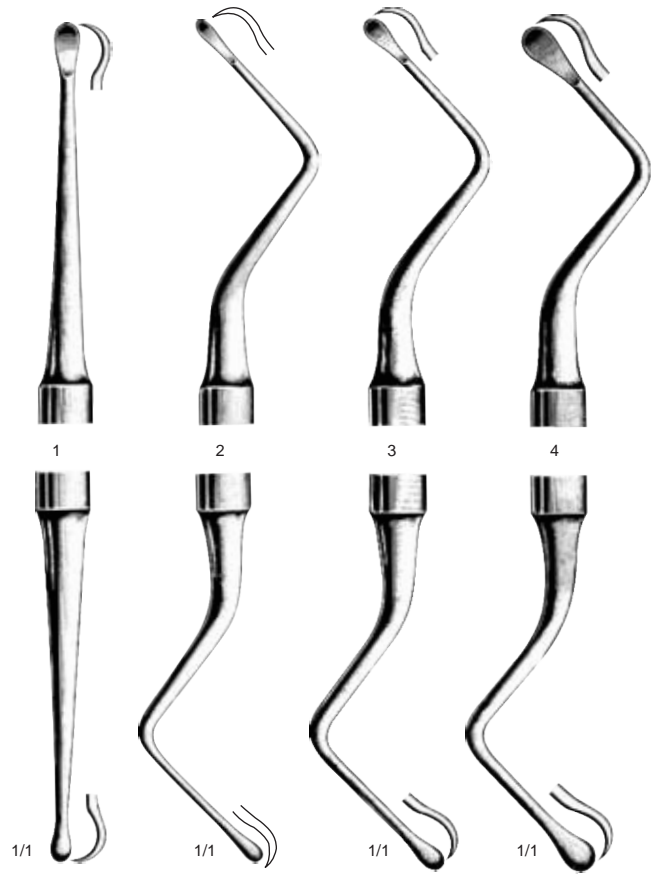
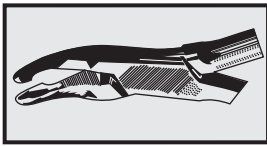

DC35-071-01 DC35-071-02 DC35-071-03 DC35-071-04

Miller-Colburn

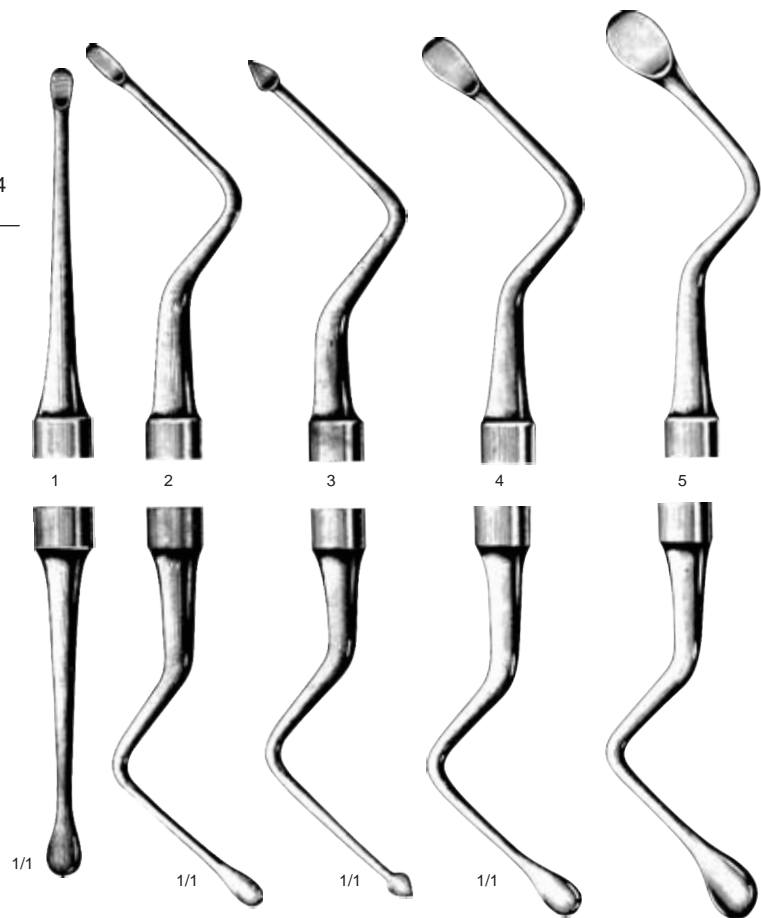

DC35-073-01 DC35-073-02 DC35-073-03 DC35-073-04 DC35-073-05

Mead

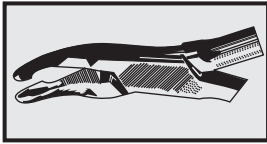

Alveolotomy Files
Periosteal Elevators

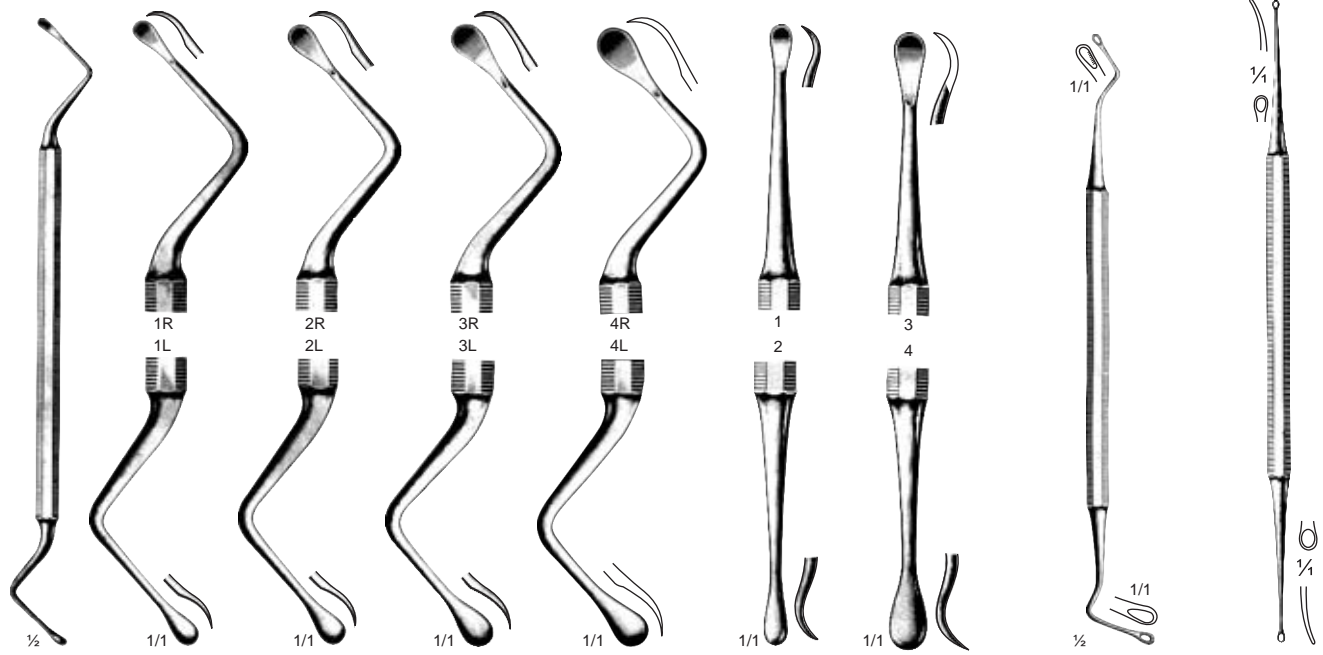

DC35-075-11 DC35-075-22 DC35-075-33 DC35-075-44 DC35-077-12 DC35-077-34 DC35-079-01 DC35-081-01

Lucas



DC35-083-01 DC35-083-02 DC35-083-03 DC35-083-04 DC35-083-05

Miller-Colburn

Williger
17 cm / 6 3/4"
DC35-085-17

Williger
16 cm / 6 1/4"
DC35-087-16

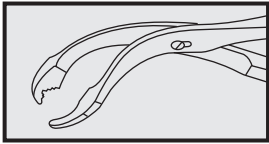

Alveolotomy Files
Periosteal Elevators

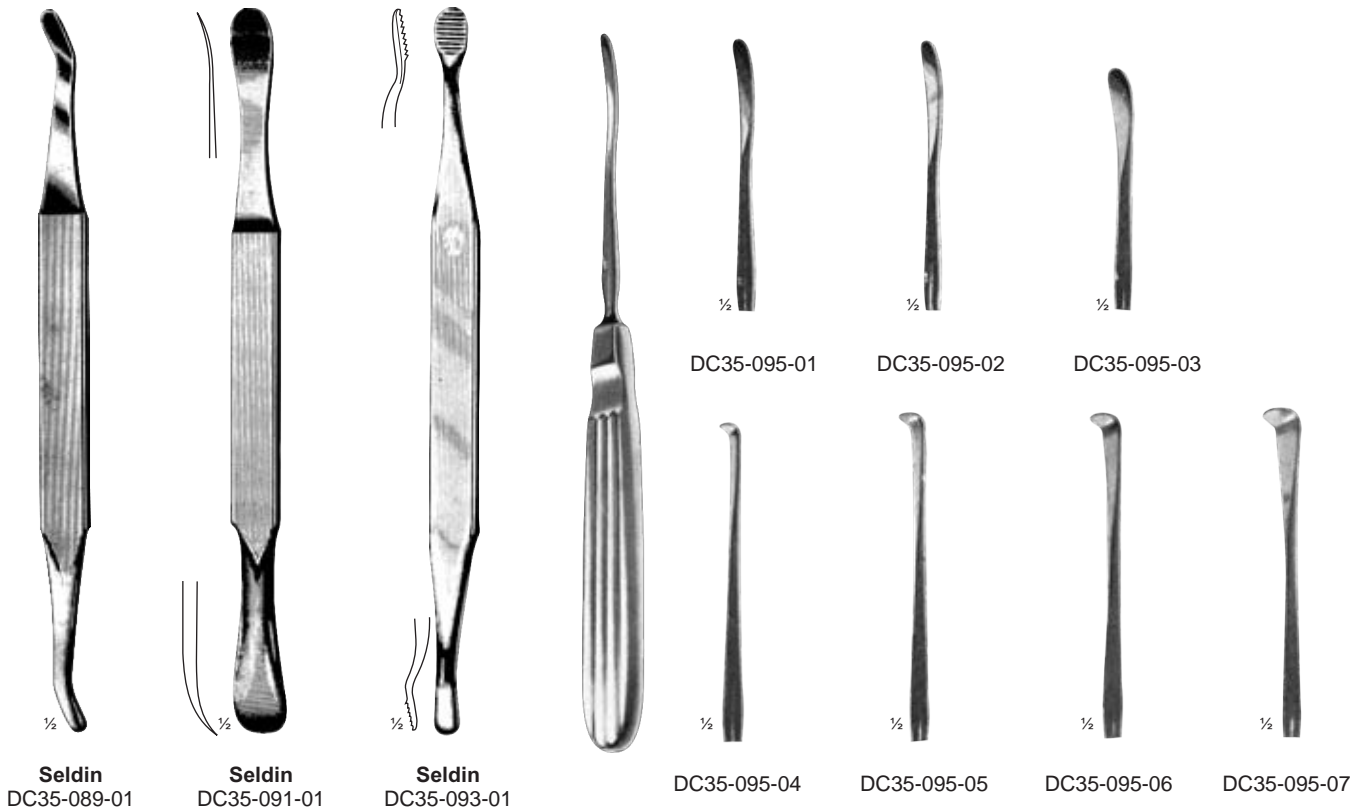

Seldin
DC35-089-01

Seldin
DC35-091-01

Seldin
DC35-093-01

DC35-095-01

DC35-095-02

DC35-095-03

DC35-095-04

DC35-095-05

DC35-095-06

DC35-095-07

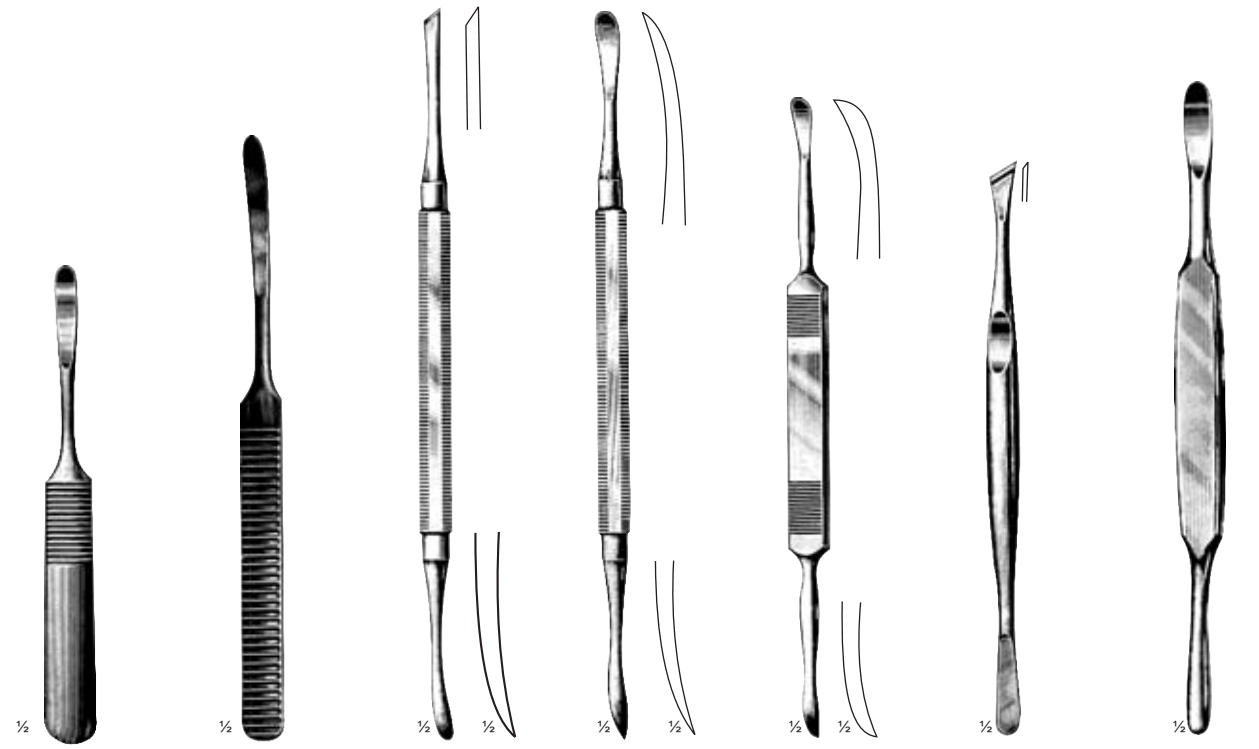

Williger
13 cm / 5"
DC35-097-13

Williger
16 cm / 6 1/4"
DC35-099-16

West 2
19 cm / 7 1/2"
DC35-101-19

Molt 9
19 cm / 7 1/2"
DC35-103-19

Ohl
17 cm / 6 3/4"
DC35-105-17

Lederer
15 cm / 6"
DC35-107-15

Barr
17 cm / 6 3/4"
DC35-109-17

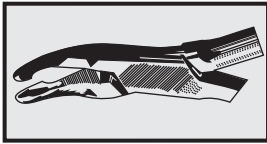

Frazier
13 cm / 5"
DC35-111-13



Kilner
DC35-113-15
15 cm/6"



Gillies
DC35-115-18
18 cm/7"



Knapp-Rollet
13 cm / 5"
DC35-117-02 (2 Teeth)
DC35-117-03 (3 Teeth)
DC35-117-04 (4 Teeth)



Barth
18 cm / 7"
DC35-119-18



Schwartz
11 cm / 4½"

Chisels	Width mm	Gouges
DC35-121-03	3	DC35-123-03
DC35-121-04	4	DC35-123-04
DC35-121-05	5	DC35-123-05
DC35-121-06	6	DC35-123-06
DC35-121-08	8	DC35-123-08
DC35-121-10	10	DC35-123-10



Schwartz
11 cm / 4½"



Fischer
15 cm / 5"



1/1
4 mm
DC35-125-04



1/1
5 mm
DC35-125-05



1/1
4 mm
DC35-125-04



1/1
5 mm
DC35-125-05



1/1
9 mm
DC35-125-09

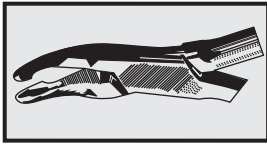

Periosteal Instruments
& Bone Punches

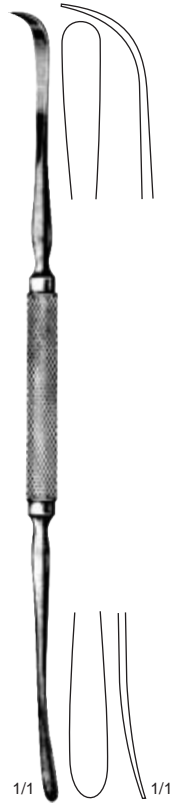

Freer
20 cm / 8"
DC35-129-20



Freer
16 cm / 6 1/4"
DC35-131-16
4 mm



Killian
16 cm / 6 1/4"
DC35-133-16

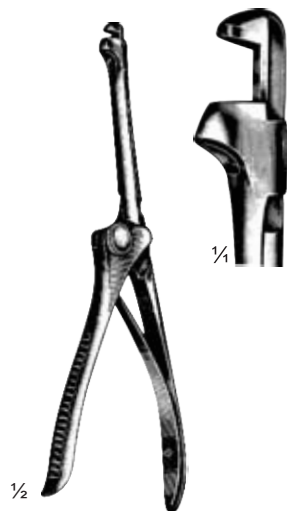

Hajeki-Calus
DC35-135-20 mm



Kerrison
DC35-137-17
DC35-137-05 mm
DC35-137-06 mm
DC35-137-07 mm

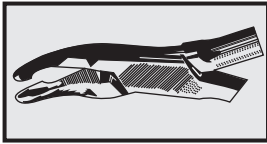

Bone Rongeurs

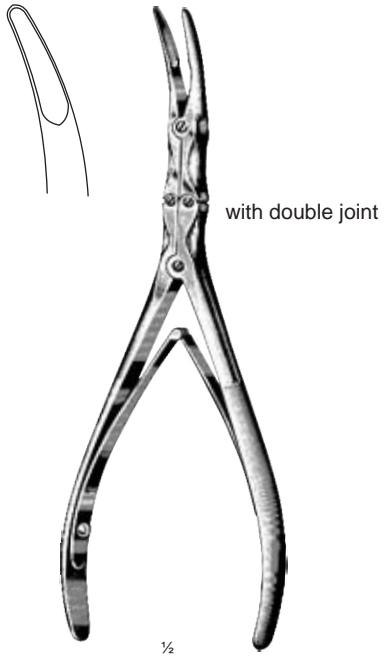

Beyer
18 cm / 7"
DC35-139-18



Cleveland
17 cm / 6 3/4"
DC35-141-17



Cleveland
15 cm / 6"
DC35-143-15



Cleveland
DC35-145-17
17 cm / 6 3/4"



Cleveland
DC35-147-14
14 cm / 5 1/2"



Friedman
DC35-149-14
14 cm / 5 1/2"



Friedman-Mini
DC35-151-12
12 cm / 4 3/4"

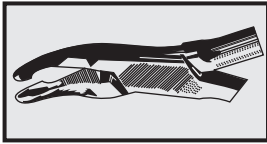

Bone Rongeurs



15 cm / 6"
DC35-153-15



Cleveland-Gardener
16 cm / 6¼"
DC35-155-16



Cleveland-Gardener
16 cm / 6¼"
DC35-157-16



18 cm / 7"
DC35-159-18



Luer
DC35-161-15
15 cm/6"

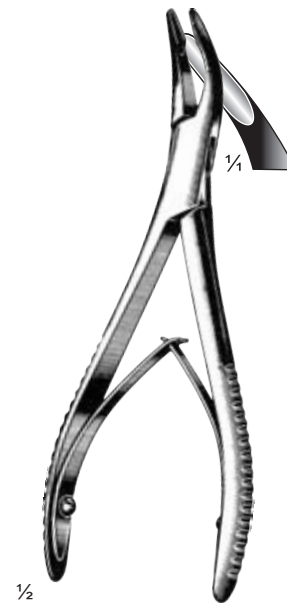

Luer
DC35-163-15
15 cm/6"

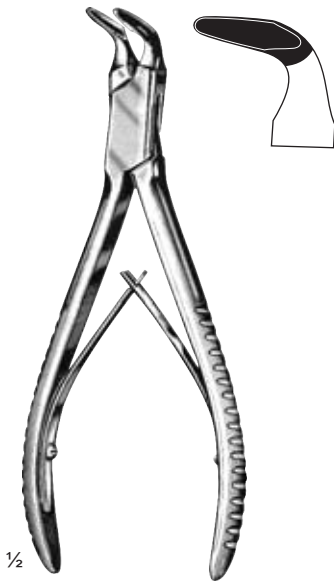
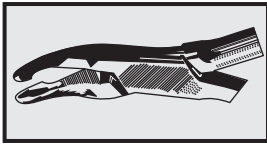

Blumenthal
15.5 cm/6"
DC35-165-15



Blumenthal
15.5 cm/6"
DC35-167-15

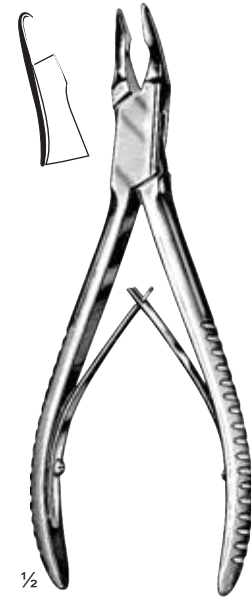

Blumenthal
15.5 cm/6"
DC35-169-15



Hartmann
18.5 cm / 7 1/4"
DC35-171-18

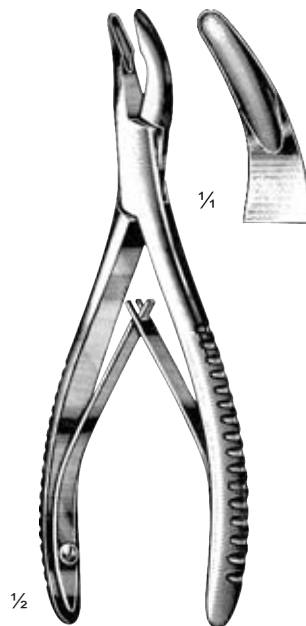

Mead
16.5 cm/6 1/2"
DC35-173-16

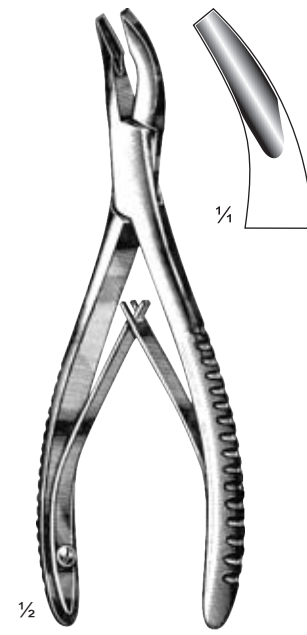

Mead
16.5 cm/6 1/2"
DC35-175-16

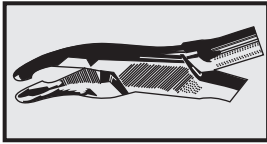

1/2

Heister
13 cm/5"
DC35-177-13



1/2

Doyen-Jansen (Molt)
12 cm/4 3/4"
DC35-179-12
Child



1/2

Doyen-Jansen (Molt)
14 cm/5 1/2"
DC35-181-14
Adult



1/2

Denhart
12 cm/4 3/4"
DC35-183-12



1/2

Roser-Koeing
cm in
16 6 1/4 DC35-185-16
19 7 1/2 DC35-185-19

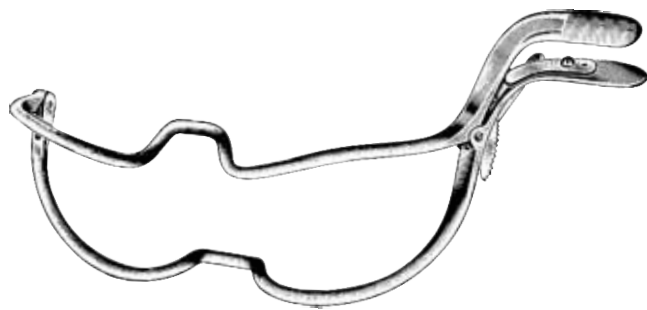

Jenning
cm in
09 3 1/2 DC35-189-09
11 4 1/4 DC35-189-11
13 5 DC35-189-13
15 6 DC35-189-15

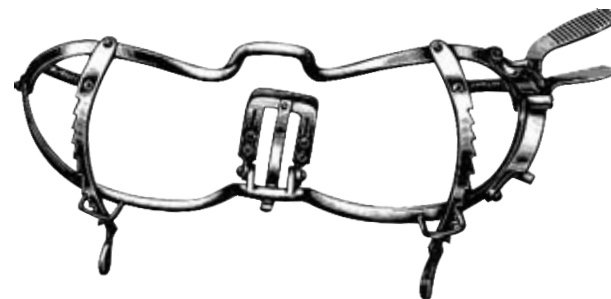

Whitehead
cm in
11 4 1/4 DC35-191-11
13 5 DC35-191-13
15 6 DC35-191-15

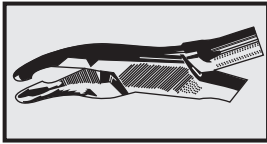

DC35-193-00
Fig. 0, For children
DC35-193-01
DC35-193-02
DC35-193-03
Fig. 1-2-3 Set
DC35-193-13

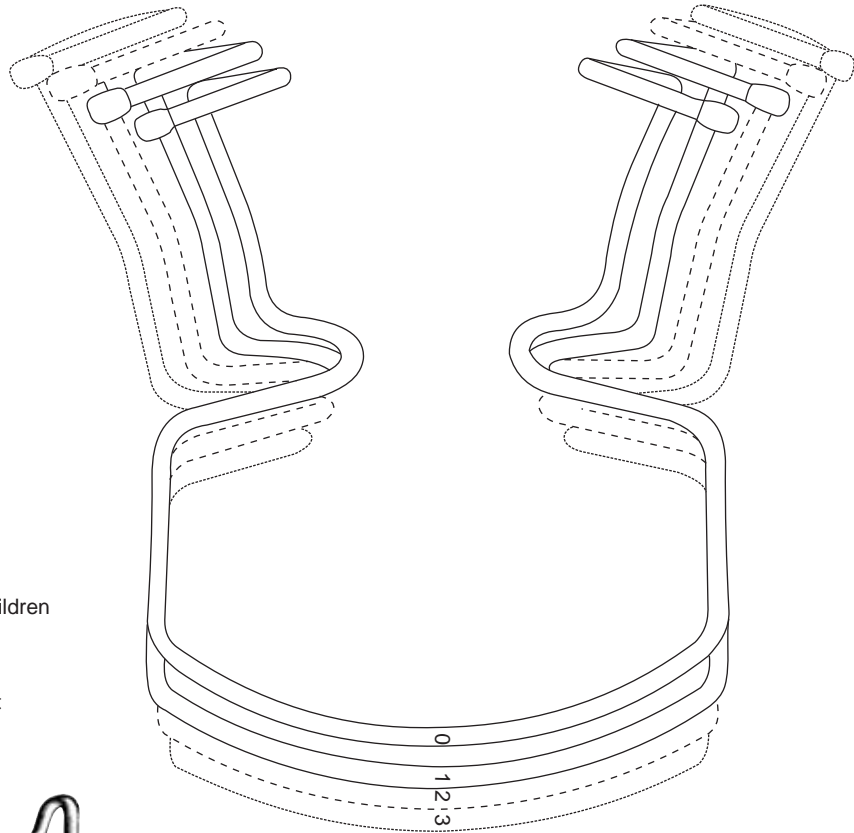

1/2
11 cm/4 1/4"
DC35-194-11

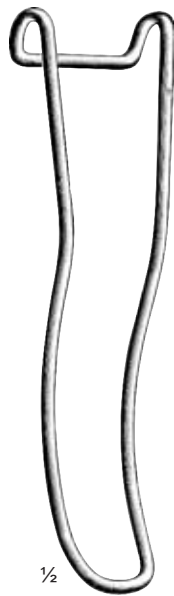

1/2



1/2

Sternmerg

	cm	in	
DC35-195-12	12	4 3/4	DC35-197-12
DC35-195-14	14	5 1/2	DC35-197-14
DC35-195-16	16	6 1/4	DC35-197-16

	DC35-201-11	Cheek Retractor
DC35-199-12	DC35-201-12	Lip Retractor
DC35-199-14	DC35-201-14	Lip Retractor
DC35-199-16	DC35-201-16	Lip Retractor
DC35-199-18	DC35-201-18	Lip Retractor
DC35-199-21	DC35-201-19	Cheek Retractors



1/2

19 cm/7 1/2"
DC35-203-19

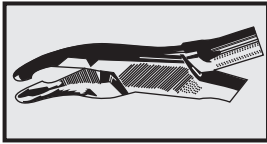

1/2
Hartmann
15 cm/6"
DC35-205-15

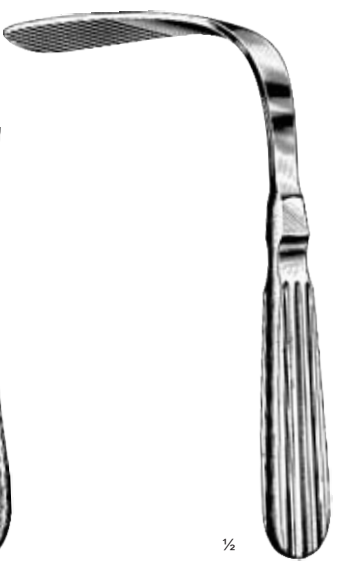

1/2
Tobold
14.5 cm / 5 1/2"
DC35-207-14

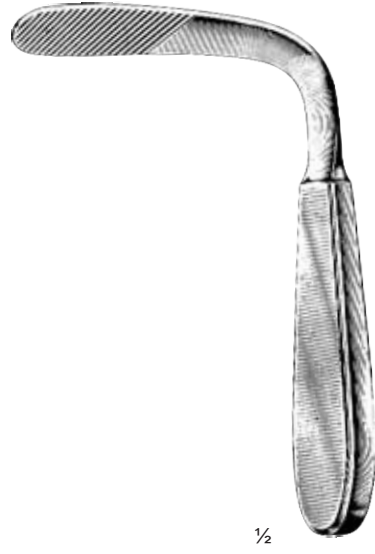

1/2
Tobold
14.5 cm/5 3/4"
DC35-209-14



1/2
Andrew
11 cm/4 1/4"
DC35-211-11

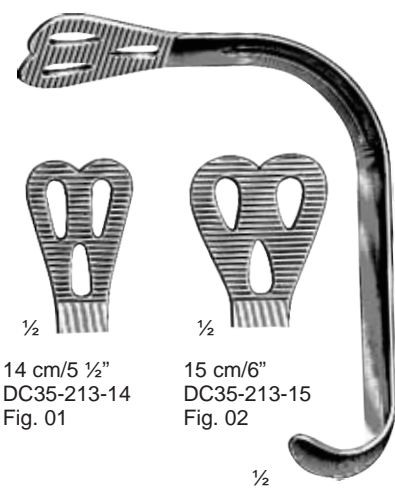

1/2
14 cm/5 1/2"
DC35-213-14
Fig. 01

1/2
15 cm/6"
DC35-213-15
Fig. 02

Wieder

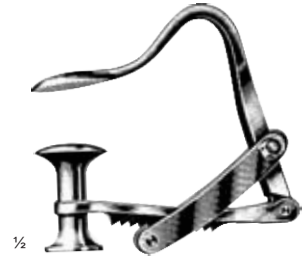

1/2
Rottenstein-Schreite
DC35-215-00

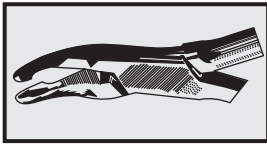

Doyen
cm in.
13 5 DC35-217-13
16 6¼ DC35-217-16



DC35-219-00
DC35-219-00



Zuwafix
DC35-221-00

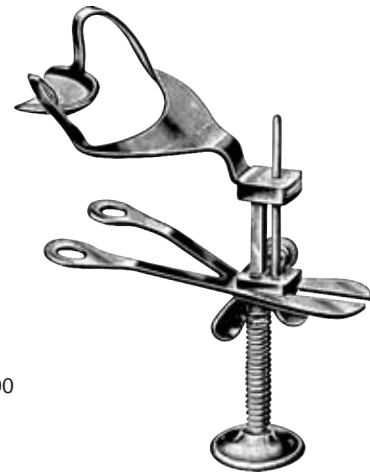

Tobold
DC35-227-14
14.5 cm / 5 ¾"

Tobold
14.5 cm / 5 ½"
DC35-225-14



Andrew
DC35-229-11
11 cm / 4 ¼"

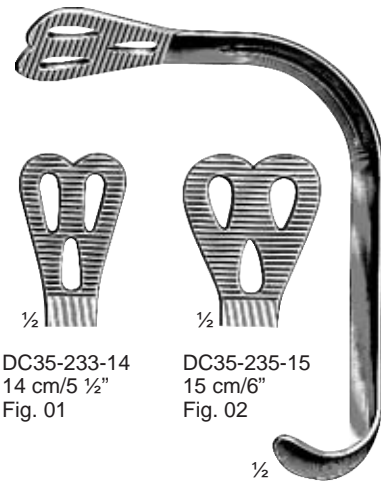

DC35-233-14
14 cm / 5 ½"
Fig. 01

DC35-235-15
15 cm / 6"
Fig. 02

Wieder

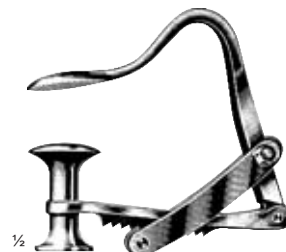

Rottenstein-Schreite
DC35-231-00

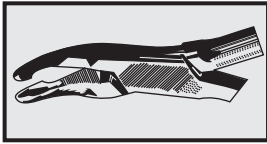

Tongue Depressors
Finger Protector
Napkin Holder

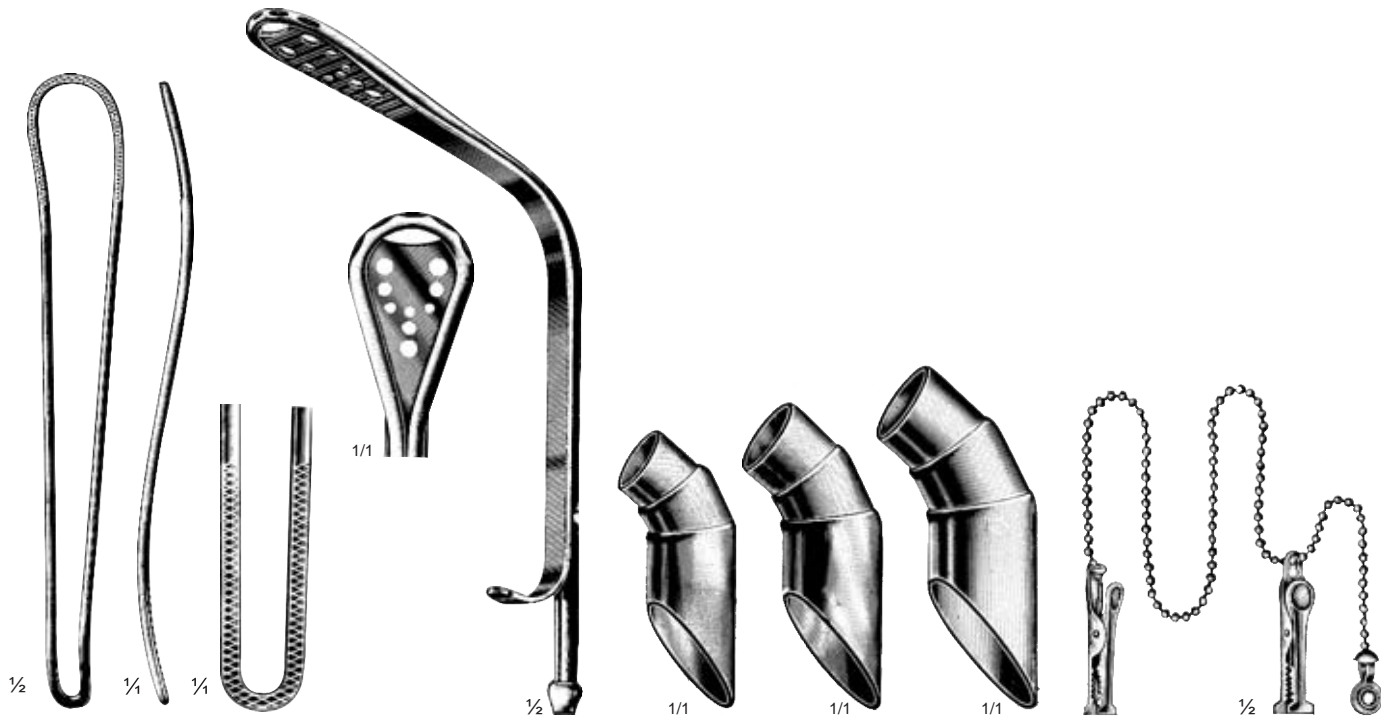

Frenzel
DC35-237-16
16.5 cm/6"

Le Mee
DC35-239-01

DC35-241-01

Langenbeck
DC35-243-02

DC35-245-03

DC35-247-01



Adams
DC35-249-01



Pitha
DC35-251-00

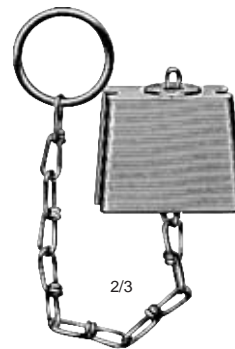

Pitha
DC35-253-00



Baisch
DC35-255-00

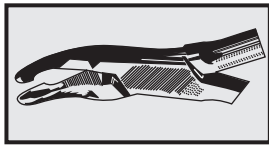

Tongue Holding Forceps
Saliva Ejectors

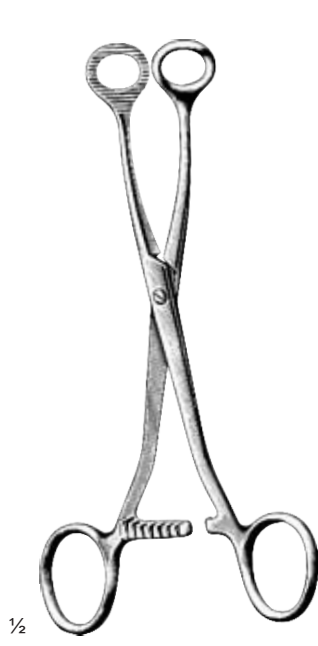

1/2

Collin
cm in DC35-257-16
16 6 1/4 DC35-257-16
18 7 DC35-257-18

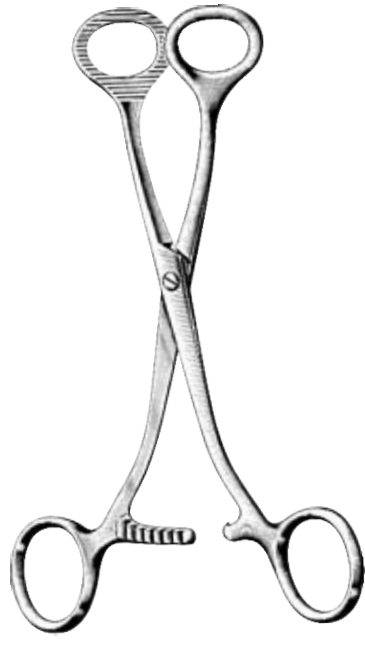

Collin
DC35-259-17
17 cm / 6 3/4"



1/2

Young
16 cm/6 1/4"
DC35-261-16



1/2

Hartmann
DC35-263-01
For children / Women



Hartmann
DC35-265-01
Regular Size



Hartmann
DC35-267-01

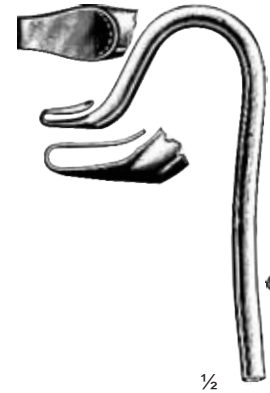

1/2

Fluofix

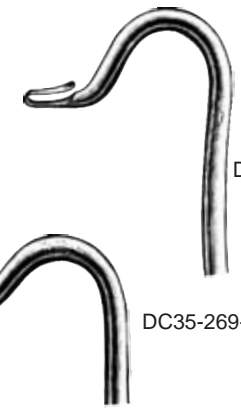

DC35-269-02



DC35-269-03

DC35-269-01

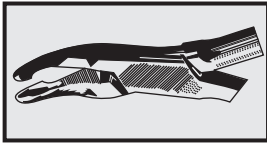

Gauze Packers
Cleft Plate Needles

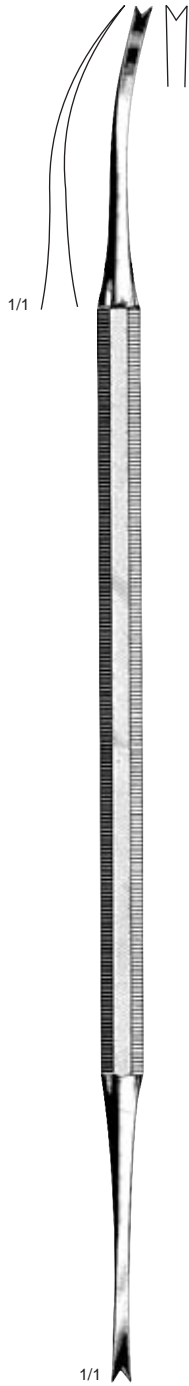

Luniatschek
18.5 cm / 7¼"
DC35-271-18

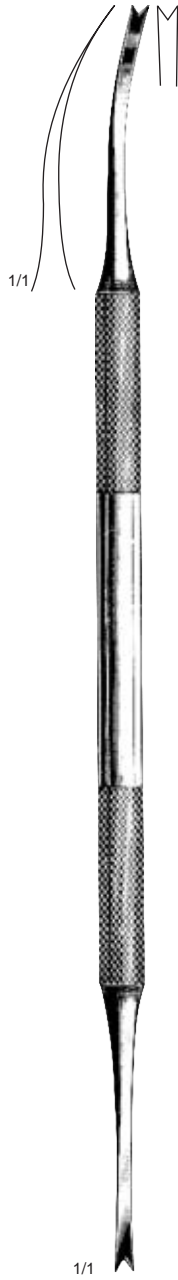

Luniatschek
17 cm / 6¾"
DC35-273-17



Claus
23 cm / 9"
DC35-275-23



Durham
25 cm / 10"
DC35-277-25



Durham
25 cm / 10"
DC35-279-25

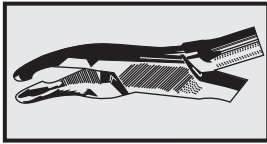

Cleft Plate Knives
Powder Blowers

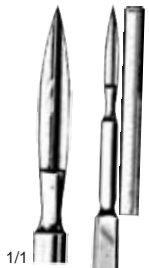

1/1

17 cm / 7"
DC35-281-17



1/1

Brophy
19 cm / 7½"
DC35-283-19

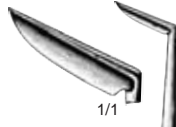

1/1

Whitehead
19 cm / 7½"
DC35-285-19



1/1

Whitehead
19 cm / 7½"
DC35-287-19

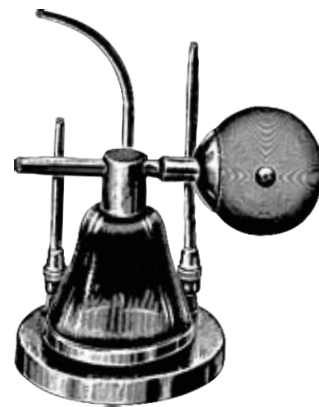

Kabierske
DC35-289-00



8 cm / 3¼"
DC35-291-08

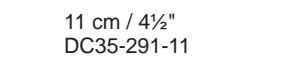

11 cm / 4½"
DC35-291-11

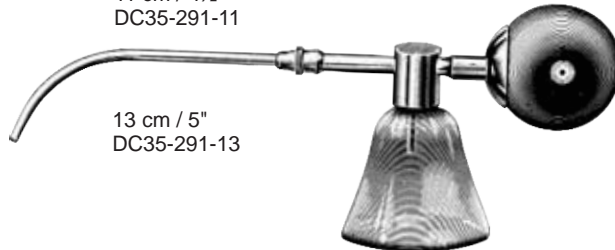

13 cm / 5"
DC35-291-13

Kabierske
DC35-291-00



1/2

Halle-Hebderich
DC35-293-00

12

ALICATES



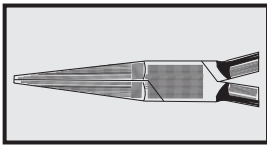

Copper Ring and Bridge Removing Pliers
Wire Seizing, Ligature & Universal Pliers



Lodo
15 cm \ 6"
DC36-001-15
Pliers for Removing
Bridges and Crowns.

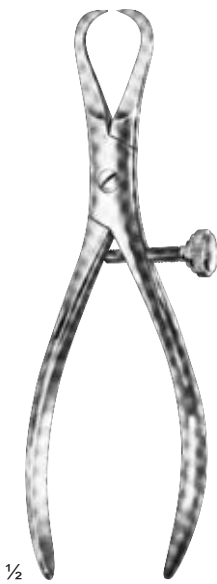

Furrer
15 cm \ 6"
DC36-003-15
Copper Ring Removing Pliers



Weingart
14 cm \ 5½"
DC36-005-14
Wire Seizing and
Ligature Pliers

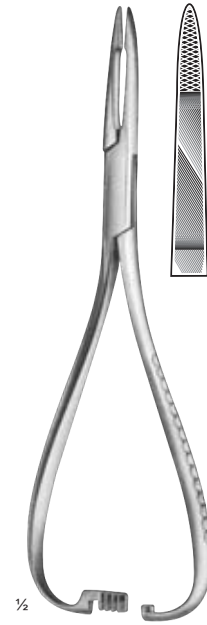

15 cm \ 6"
DC36-007-15
Wire Seizing and
Ligature Pliers

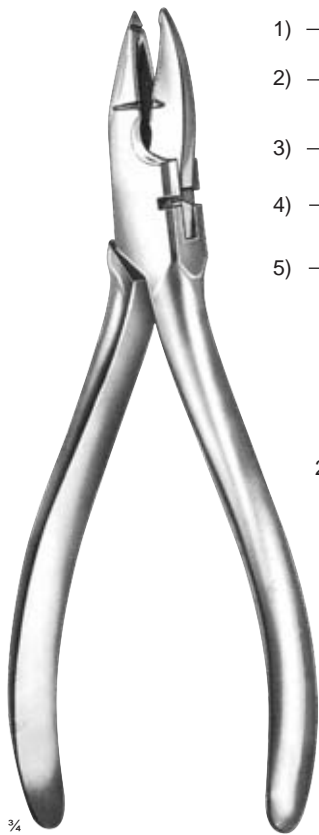

Waldsachs-Universal
15.5 cm \ 6"
DC36-009-15
Universal Pliers

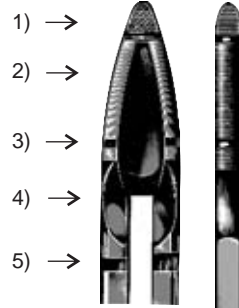

- to be used as:
1) Pin and Ligature Pliers
2-3) Clasp Bending Pliers
4) Bar Bending Pliers
5) Cutting Pliers



Universal
15.5 cm \ 6"
DC36-011-15
Universal Pin Roughening,
Cutting and Bending Forceps



Universal
15.5 cm \ 6"
DC36-011-15

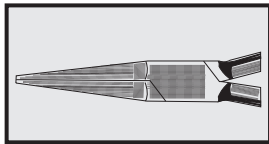

Bar, Clasp and Wire Bending Pliers
Flat Nose Plier



McKellops
16 cm \ 6¼"
DC36-013-16

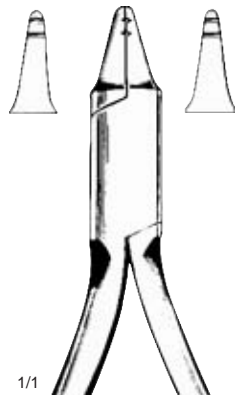

Oliver
12.5 cm \ 5"
DC36-015-12

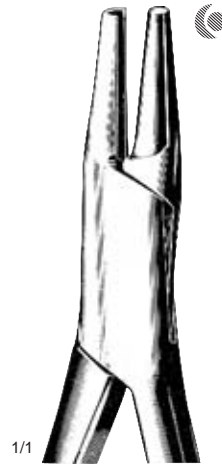

McKellops
17 cm \ 6¾"
DC36-017-17

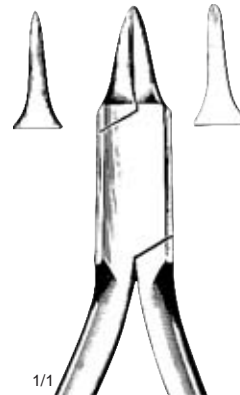

Waldron
12.5 cm \ 5"
DC36-019-12

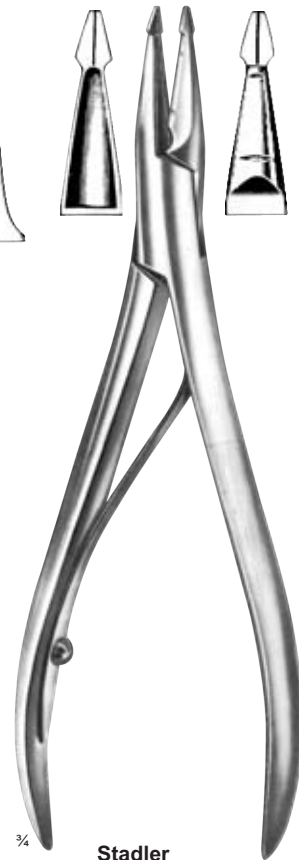

Stadler
15 cm \ 6"
DC36-021-15

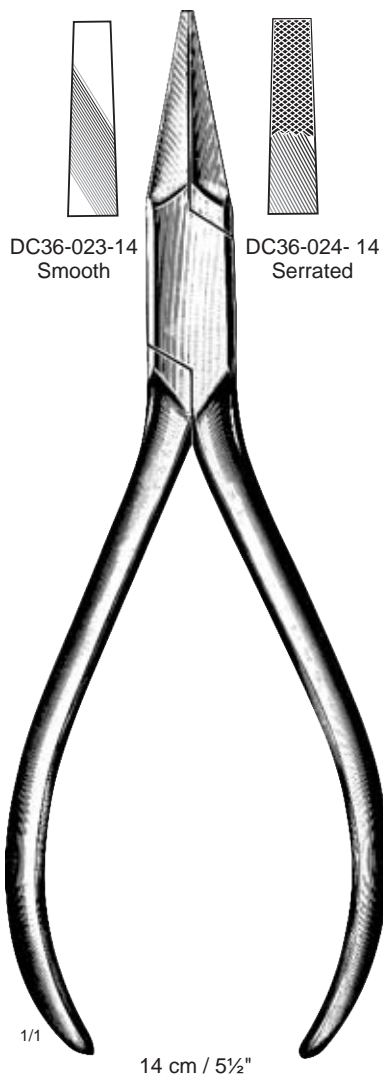

DC36-023-14
Smooth

DC36-024-14
Serrated

1/1
14 cm / 5½"

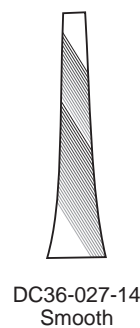

DC36-027-14
Smooth



DC36-029-14
Serrated



Langenbeck
14 cm / 5½"

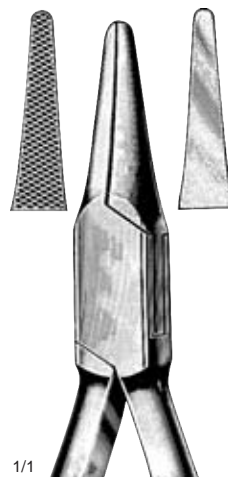

Goslee
14 cm / 5½"
DC36-025-14

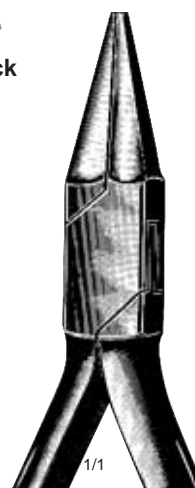

DC36-031-12
Smooth

12.5 cm / 5"



DC36-033-12
Serrated

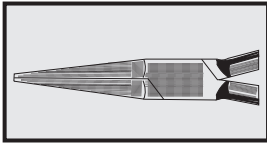

Pliers
Flat and Nose Pliers end Nippers

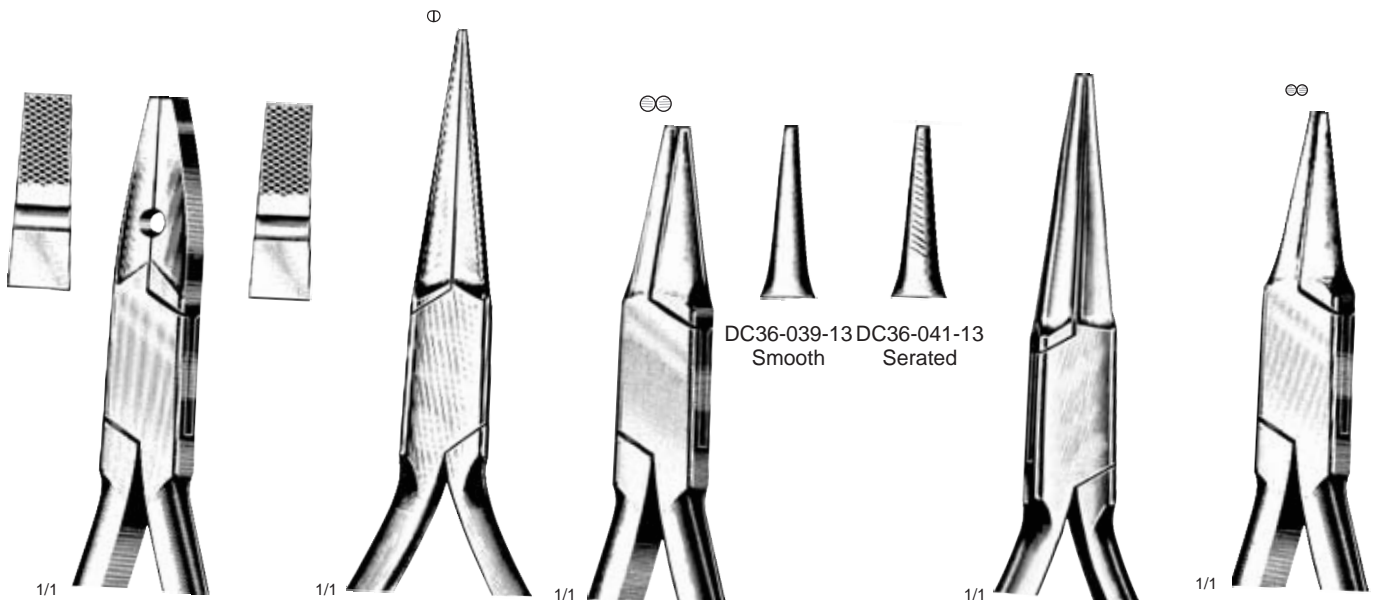

1/1 14 cm / 5½" DC36-035-14
 1/1 **Langenbeck** 14 cm / 5½" DC36-037-14
 1/1 13 cm / 5" DC36-039-13 DC36-041-13
 Smooth Serated
 1/1 **Langenbeck** 14 cm / 5½" DC36-043-14
 1/1 13 cm / 5" DC36-045-13

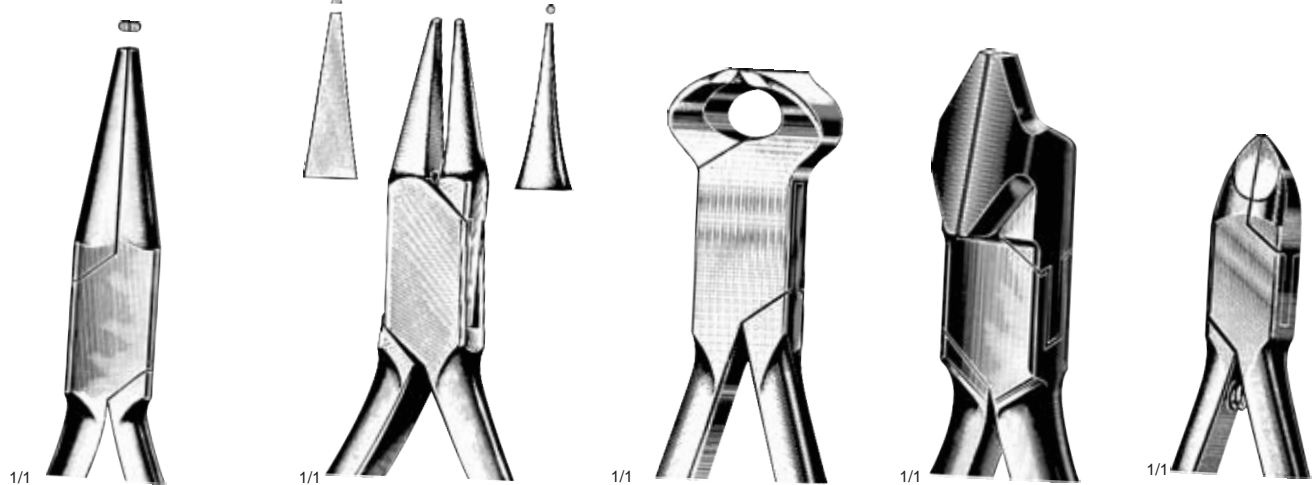

1/1 13 cm / 5" DC36-047-13
 1/1 15 cm / 6" DC36-049-15
 1/1 12.5 cm / 5" DC36-051-12
 1/1 13 cm / 5" DC36-053-13
 1/1 11 cm / 4½" DC36-055-11

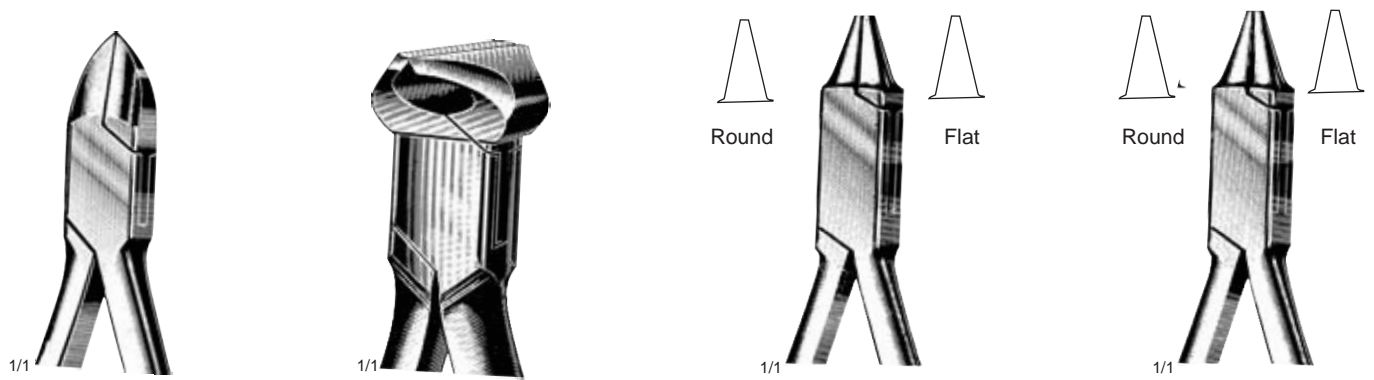

1/1 11 cm / 4½" DC36-057-11
 1/1 12 cm / 4½" DC36-059-12
 1/1 **Angle** 12 cm / 4¾" DC36-061-12
 Round Flat
 Round Flat
 1/1 12 cm / 4¾" DC36-063-12

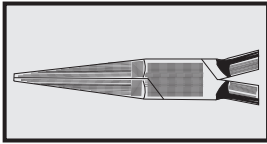

Flat and Nose Pliers end Nippers
Clasp and Arch Bending Pliers
Ligature Pliers



1/1

Dumont
11.5 cm / 4½"

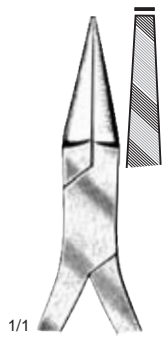

1/1

DC36-065-11

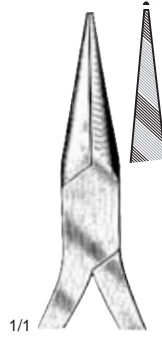

1/1

DC36-067-11

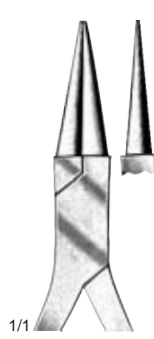

1/1

DC36-069-11



1/1

Dumont
11.5 cm / 4½"



1/1

DC36-071-11



1/1

DC36-073-11

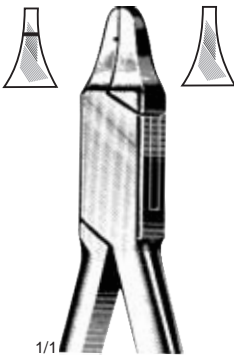

1/1

Angle
13 cm / 5"
DC36-075-13

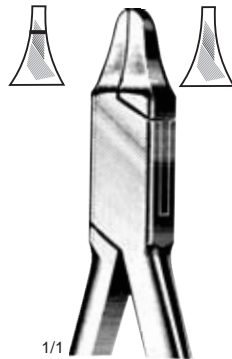

1/1

Angle
13 cm / 5"
DC36-077-13

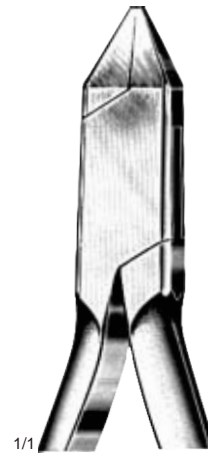

1/1

Adams
13 cm / 5"
DC36-079-13



1/1

Aderer
13 cm / 5"
DC36-081-13

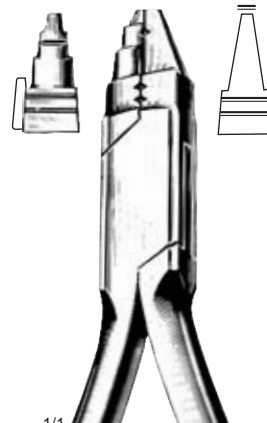

1/1

Young
13 cm / 5"
DC36-083-13



1/1

Aderer
14 cm / 5½"
DC36-085-14

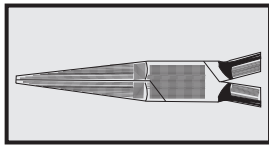

Clasp and Arch Bending Pliers
Ligature Pliers



1/1

Aderer
11.5 cm / 4½"
DC36-087-11

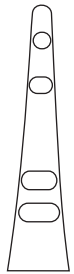

1/1

Aderer
14 cm / 5½"
DC36-089-14

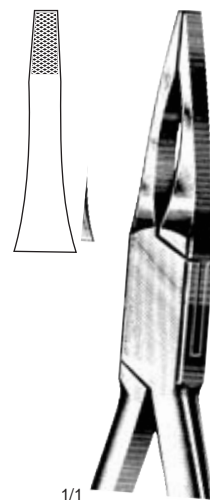
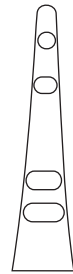

1/1

Fischer
13.5 cm / 5¼"
DC36-091-13



1/1

Diamant
16 cm / 6¼"
DC36-093-16

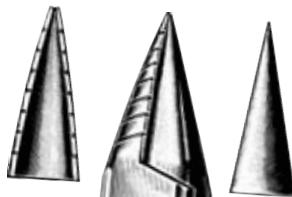

1/1

Schwarz
14.5 cm / 5¾"
DC36-094-14



1/1

Fischer
14 cm / 5½"
DC36-095-14

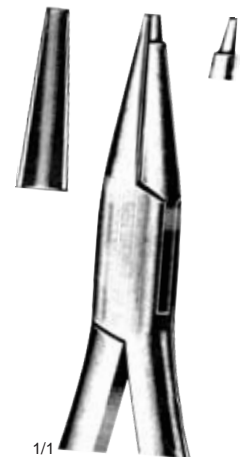

1/1

Andresen
14 cm / 5½"
DC36-097-14

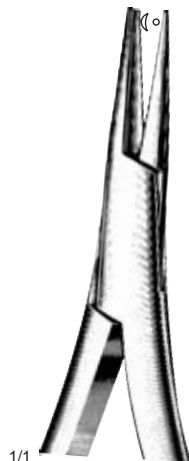

1/1

Schwarz
13 cm / 5"
DC36-099-13



1/1

Schwarz
13 cm / 5"
DC36-101-13



1/1

Schwarz
13 cm / 5"
DC36-103-13

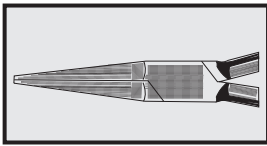

Crown Pliers, Counting Pliers
Ligature Pliers



Tryfus
16.5 cm / 6½"
DC36-105-16

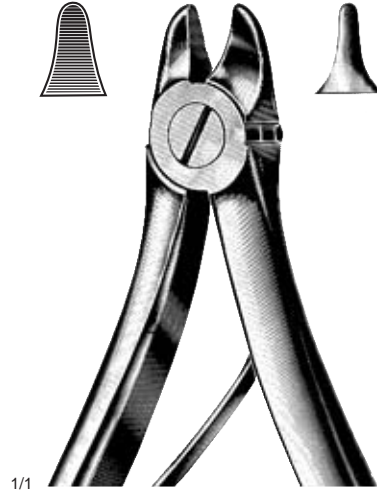

Peeso
14.5 cm / 5¾"
DC36-107-14



How
14 cm / 5½"
DC36-109-14

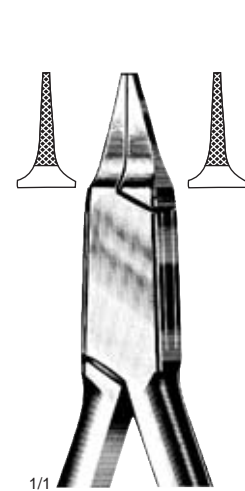

Frevert
12 cm / 4¾"
DC36-111-12

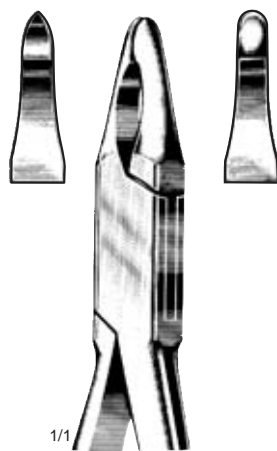

Johnson
13 cm / 5"
DC36-113-13

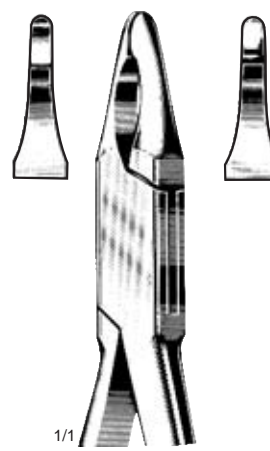

Johnson
13 cm / 5"
DC36-115-13

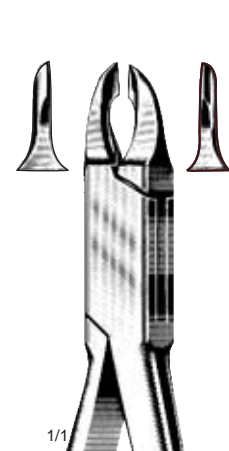

Angle
13 cm / 5"
DC36-117-13

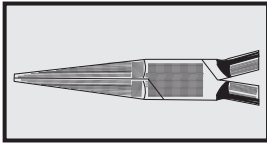

Crown Pliers, Counting Pliers
Rubber Dam Punch

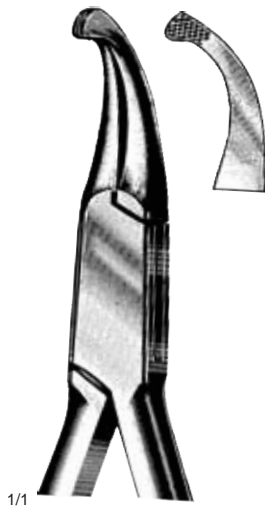

1/1
How
14 cm / 5½"
DC36-119-14



1/1
Ziebe
13 cm / 5"
DC36-121-13

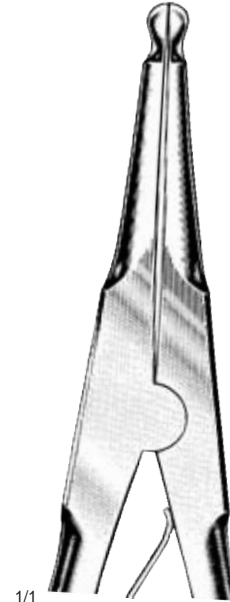

1/1
Herbst
14 cm / 5½"
DC36-123-14

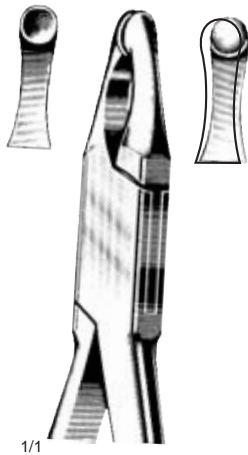

1/1
Abell
13 cm / 5"
DC36-125-13

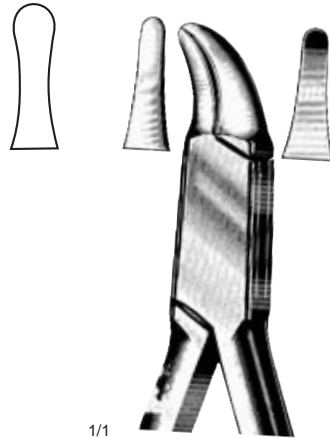

1/1
Reynolds
12.5 cm / 5"
DC36-127-12

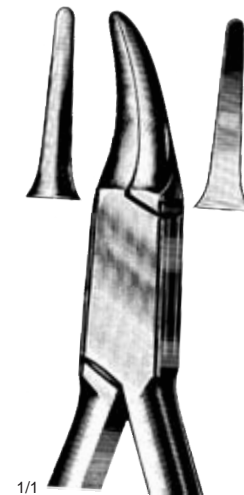

1/1
Gordon
14 cm / 5½"
DC36-129-14

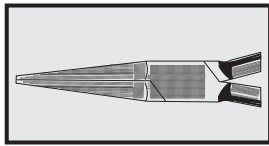

Copper Ring and Bridge Removing Pliers
Wire Seizing and Ligature Pliers
Universal Pliers

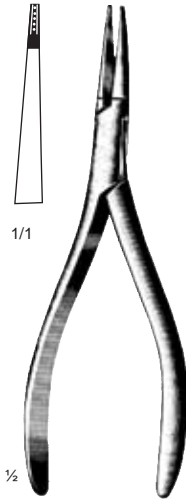

13 cm / 5"
DC36-131-13

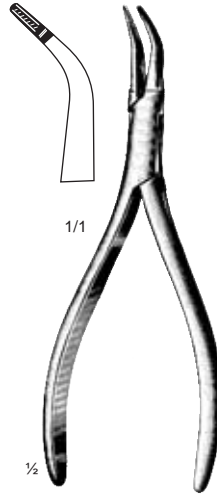

13 cm / 5"
DC36-133-13

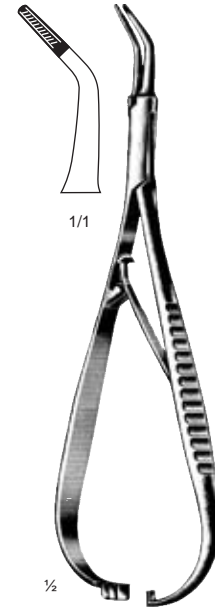

16 cm / 6 1/4"
DC36-135-16

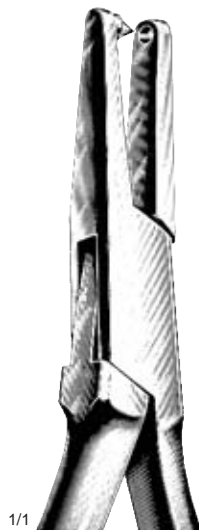

Ainworth
16 cm / 6 1/4"
DC36-137-16

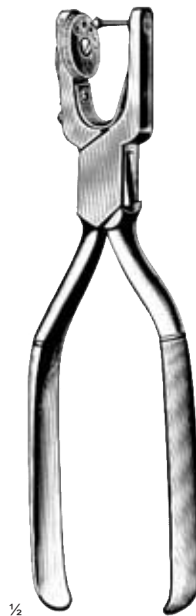

Tuttle
15 cm / 6"
DC36-139-15

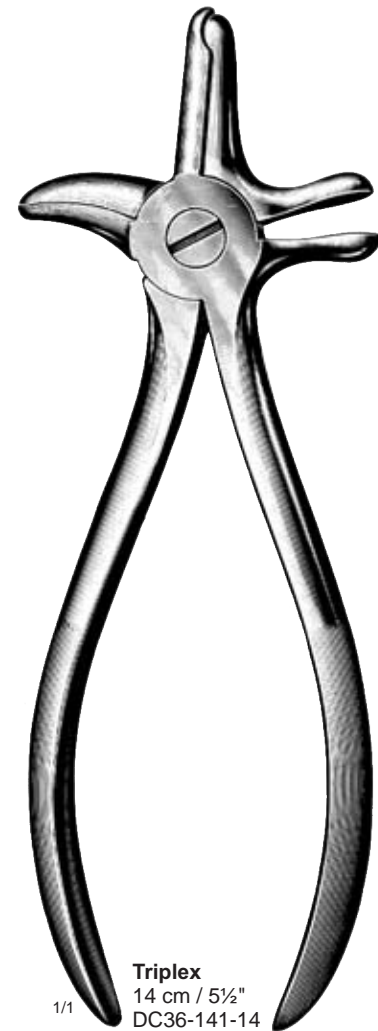

Triplex
14 cm / 5 1/2"
DC36-141-14

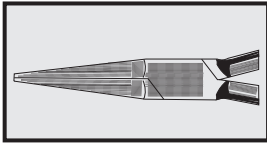

Copper Ring and Bridge Removing Pliers
Wire Seizing and Ligature Pliers
Universal Pliers



1/2

16 cm/6 1/4" DC36-157-16
18 cm/7" DC36-159-18
23 cm/9" DC36-161-23



14 cm/5 1/2" DC36-163-14



15 cm/6" DC36-165-15



13 cm/5" DC36-167-13



13 cm/5 1/2" DC36-169-13



13 cm/5 1/2" DC36-171-13
Angled at 15°, with or without
spring on the handles.



13 cm/5 1/2" DC36-173-13



13 cm/5 1/2" DC36-175-13



13 cm/5 1/2" DC36-177-13
Angled at 15°



13 cm/5 1/2" DC36-179-13
Angled at 15°

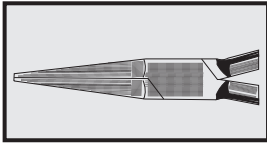

Copper Ring and Bridge Removing Pliers
Wire Seizing and Ligature Pliers
Universal Pliers



13 cm/5 1/2"
DC36-181-13



13 cm/5 1/2"
DC36183-13



15 cm/6"
DC36-185-15
Hard wire 0.55x0.64
Long handle



13 cm/5 1/2"
DC36-187-13



13 cm/5 1/2"
DC36-189-13

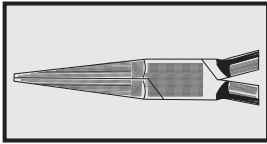

Diagonal Wire Cutter
13 cm/5 1/2"
DC35-191-13

Parallel Action Wire Cutter
11 cm/4 1/2"
DC35-195-11

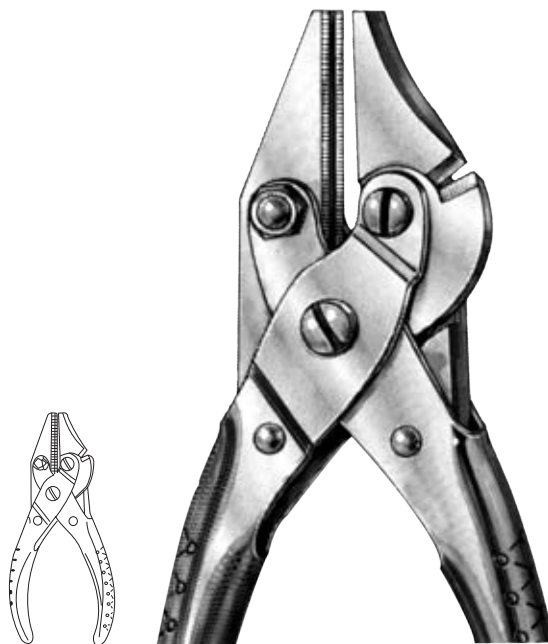

Parallel Action Wire Cutter
11 cm/4 1/2"
DC35-197-11

13

ARTICULADORES Y BANDEJAS DE IMPRESIÓN.

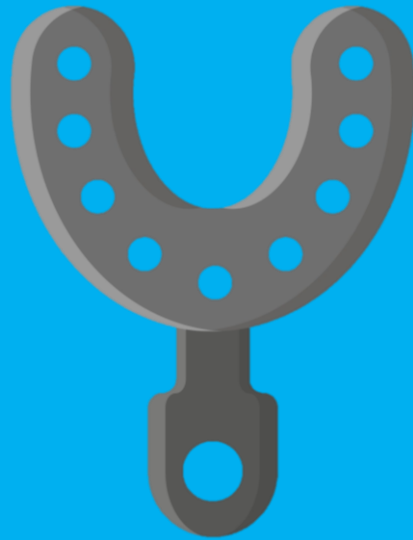

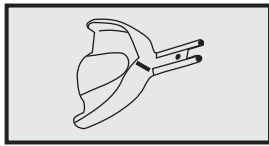

Articulators



DC37-001-00

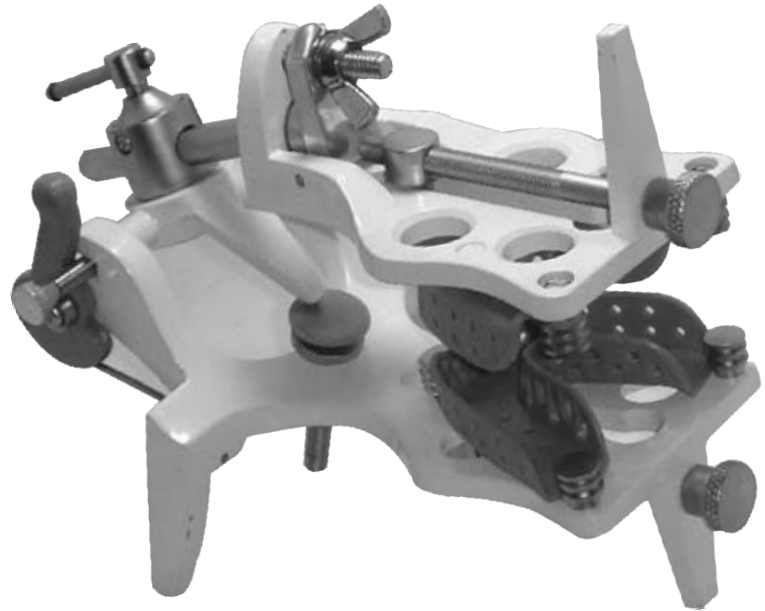

DC37-003-00



DC37-005-00

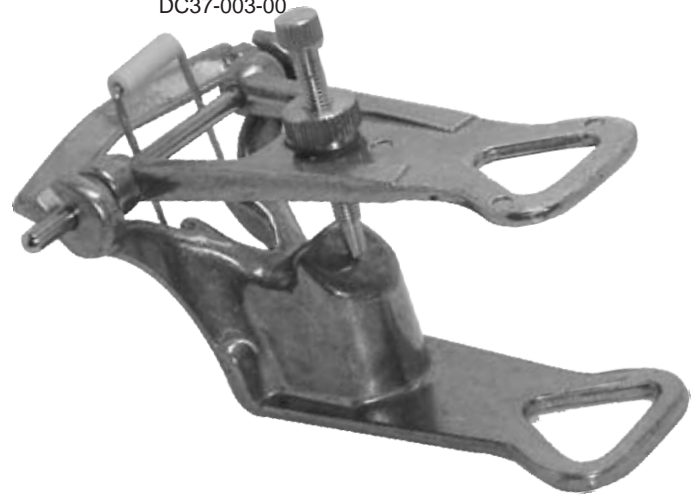

DC37-007-00



DC37-009-00

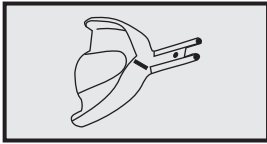

Articulators



DC37-011-00



DC37-013-00



DC37-015-00



DC37-017-00

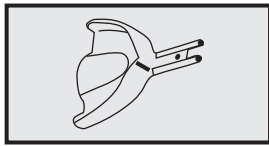

Impression Trays

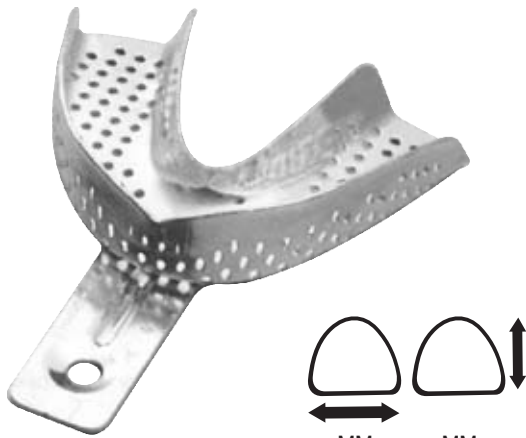

		MM	MM
DC37-019-U1	XXS	63	48
DC37-019-U2	XS	66	51
DC37-019-U3	S	68	54
DC37-019-U4	M	71	58
DC37-019-U5	L	74	62
DC37-019-U6	XL	76	63

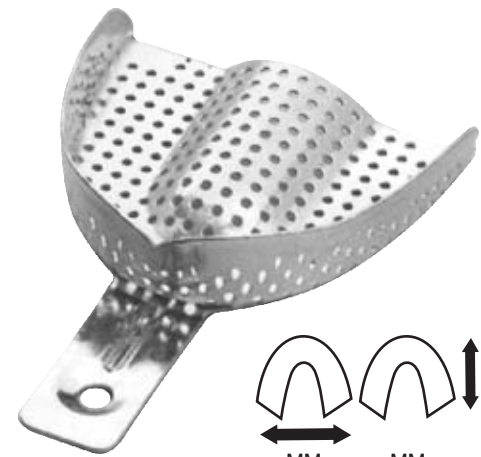

		MM	MM
DC37-021-L1	XXS	56	48
DC37-021-L2	XS	59	50
DC37-021-L3	S	72	52
DC37-021-L4	M	76	57
DC37-021-L5	L	77	56
DC37-021-L6	XL	78	59

Set of Twelve DC37-022-12

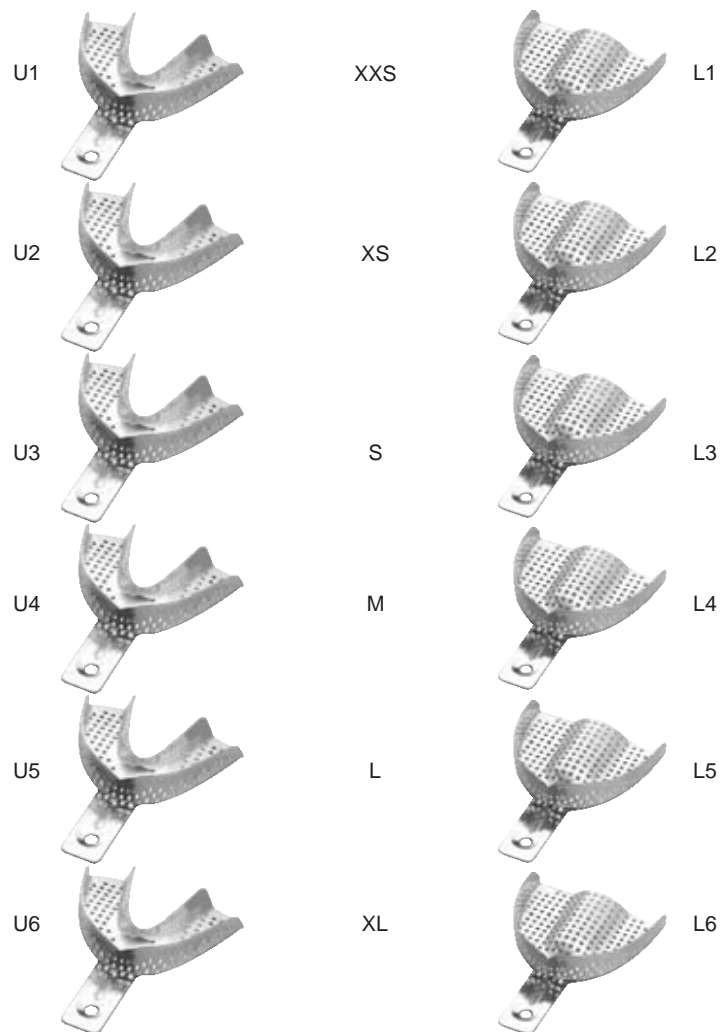

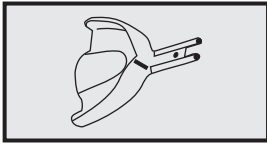

Impression Trays



		MM	MM
DC37-023-U1	L	81	67
DC37-023-U4	M	71	64
DC37-023-U7	S	70	57

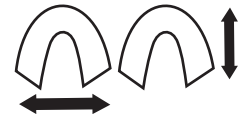
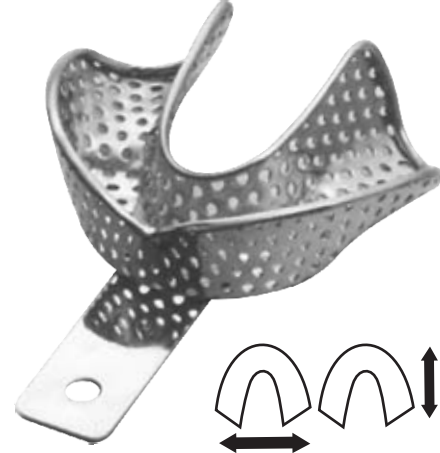

		MM	MM
DC37-025-L20	L	81	60
DC37-025-L21	M	79	57
DC37-025-L22	S	76	54

Set of Six DC37-027-06

U1



L



L20

U4



M



L21

U7



S



L22

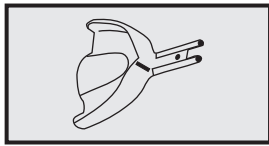

Impression Trays

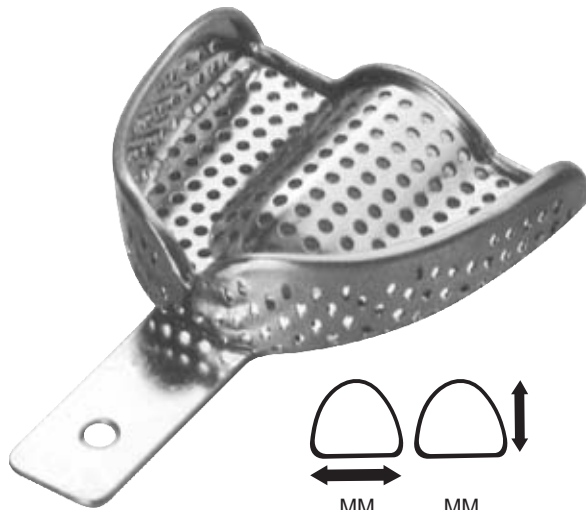

		MM	MM
DC37-029-U1	XXS	63	47
DC37-029-U2	XS	64	51
DC37-029-U3	S	66	53
DC37-029-U4	M	69	57
DC37-029-U5	L	71	60
DC37-029-U6	XL	73	62



		MM	MM
DC37-031-L1	XXS	55	47
DC37-031-L2	XS	60	49
DC37-031-L3	S	72	54
DC37-031-L4	M	74	57
DC37-031-L5	L	76	59
DC37-031-L6	XL	78	61

Set of Twelve DC37-033-12

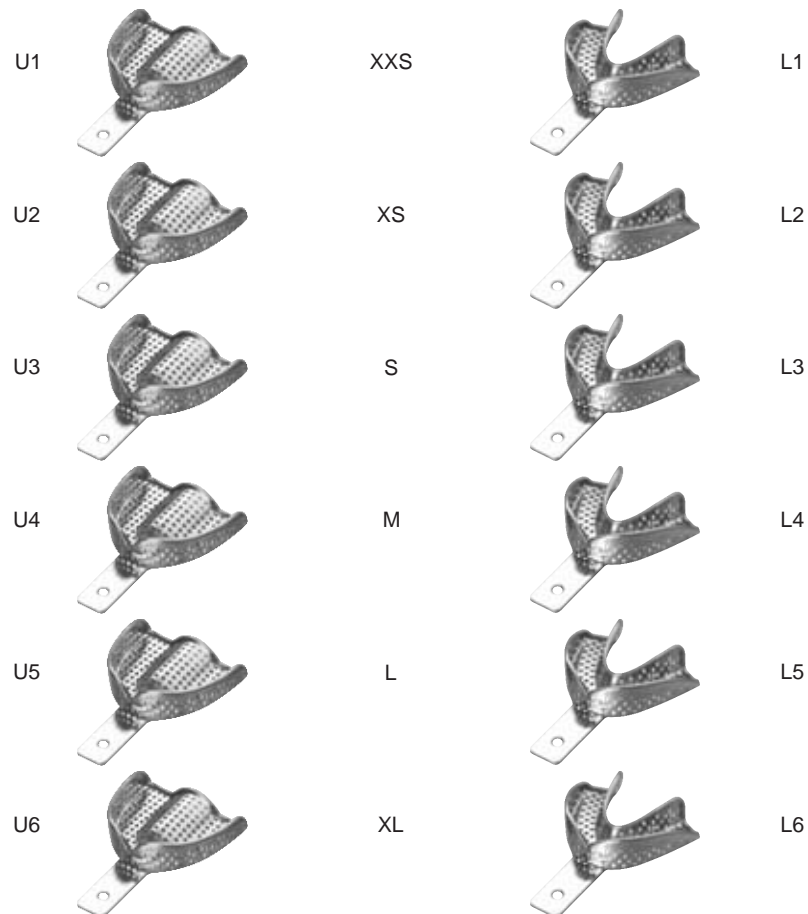

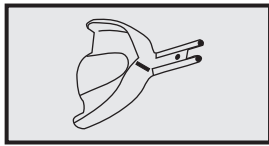

Impression Trays

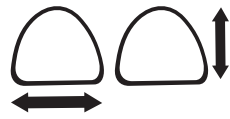
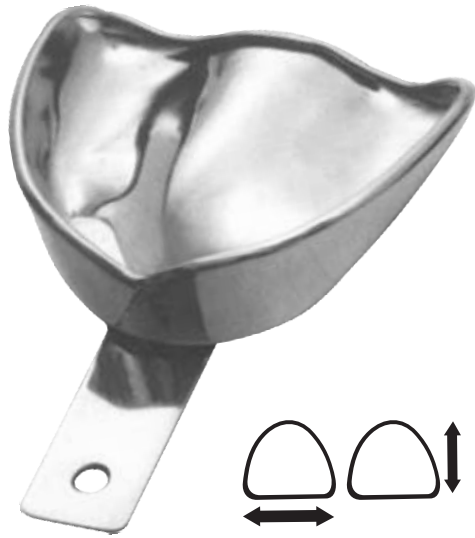

		MM	MM
DC37-035-U1	L	81	67
DC37-035-U4	M	71	64
DC37-035-U7	S	70	57

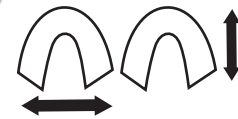

		MM	MM
DC37-037-L20	L	81	60
DC37-037-L21	M	79	57
DC37-037-L22	S	76	54

Set of Six DC37-039-06

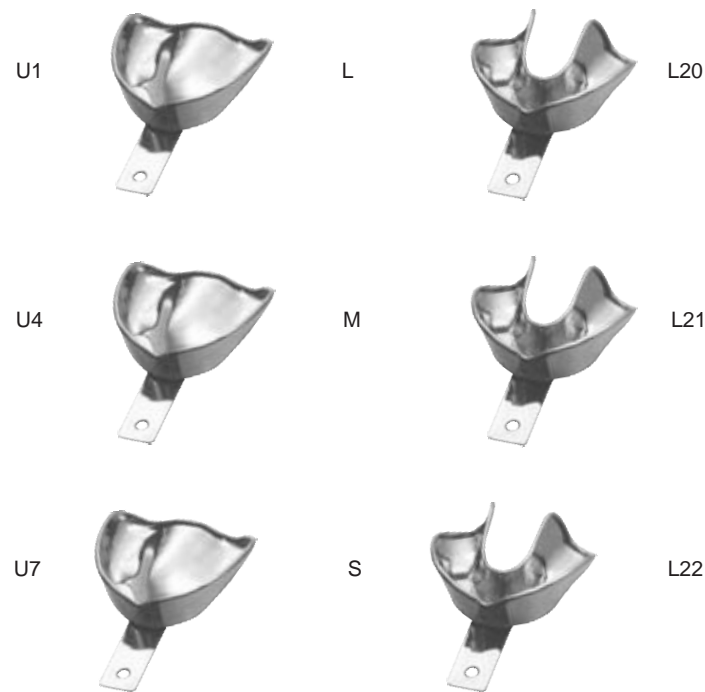

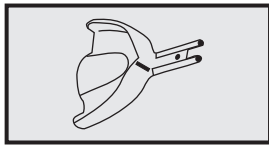

Impression Trays

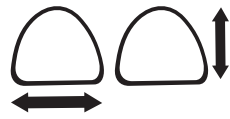
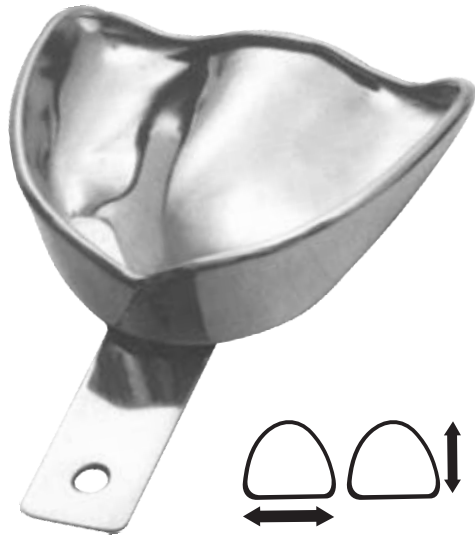

		MM	MM
DC37-041-U1	L	81	67
DC37-041-U4	M	71	64
DC37-041-U7	S	70	57

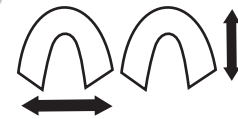

		MM	MM
DC37-043-L20	L	81	60
DC37-043-L21	M	79	57
DC37-043-L22	S	76	54

Set of Six DC37-045-06

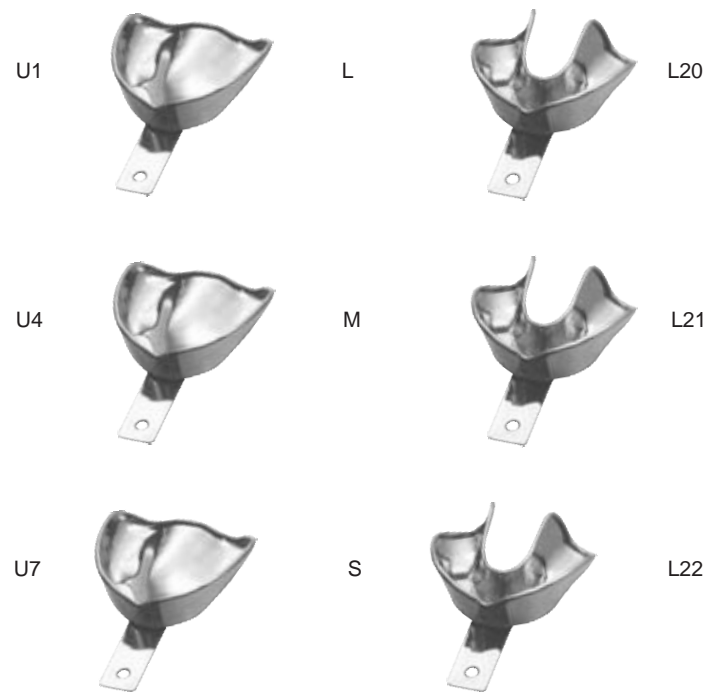

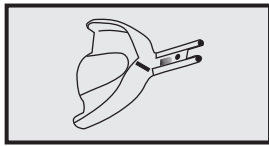

Impression Trays



		MM	MM
DC37-047-U1	XL	73	62
DC37-047-U2	L	71	60
DC37-047-U3	M	69	57
DC37-047-U4	S	66	53
DC37-047-U5	XS	64	51
DC37-047-U6	XXS	61	47

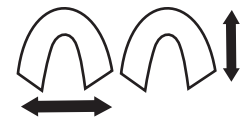

		MM	MM
DC37-049-L1	XL	78	61
DC37-049-L2	L	76	59
DC37-049-L3	M	75	57
DC37-049-L4	S	72	54
DC37-049-L5	XS	60	49
DC37-049-L6	XXS	55	47

Set of Ten DC37-051-12

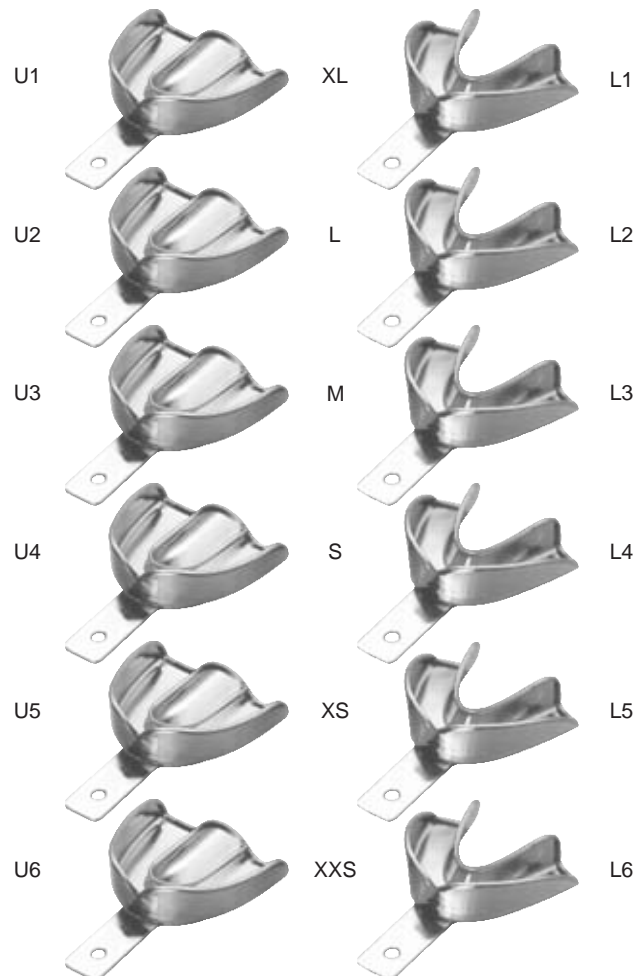

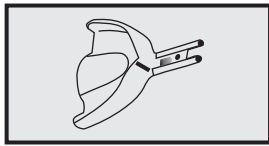

Impression Trays



		MM	MM
DC37-053-U1	XL	81	63
DC37-053-U2	L	74	60
DC37-053-U3	M	71	55
DC37-053-U4	NM	67	53
DC37-053-U5	S	65	51

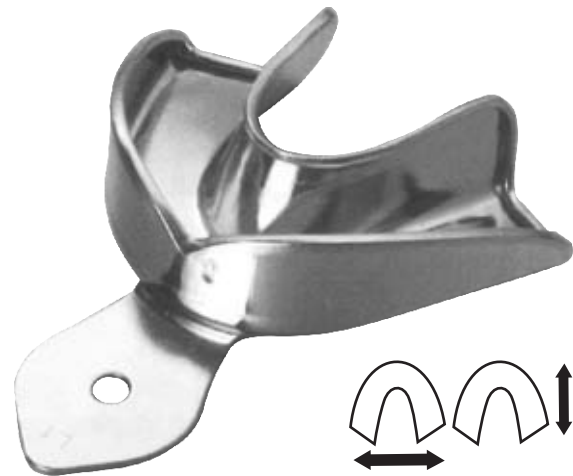

		MM	MM
DC37-055-L1	XL	80	63
DC37-055-L2	L	78	59
DC37-055-L3	M	76	57
DC37-055-L4	NM	72	57
DC37-055-L5	S	69	50

Set of Ten DC37-057-10

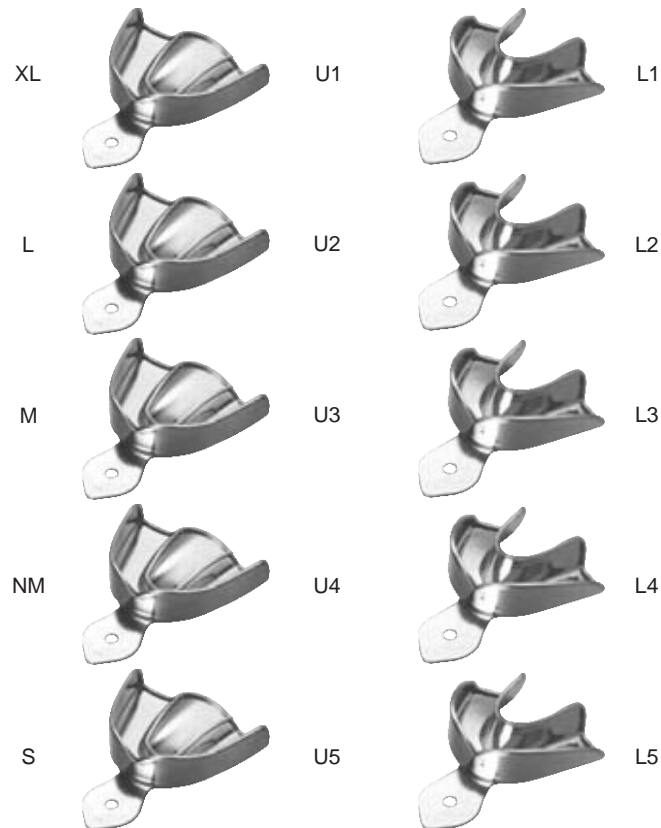

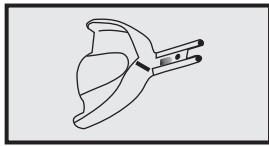

Impression Trays



		MM	MM
DC37-059-U1	XL	68	62
DC37-059-U2	L	75	60
DC37-059-U3	M	73	53
DC37-059-U4	NM	69	54
DC37-059-U5	S	68	52



		MM	MM
DC37-061-L1	XL	82	63
DC37-061-L2	L	81	61
DC37-061-L3	M	78	57
DC37-061-L4	NM	74	60
DC37-061-L5	S	71	53

Set of Ten DC37-063-10

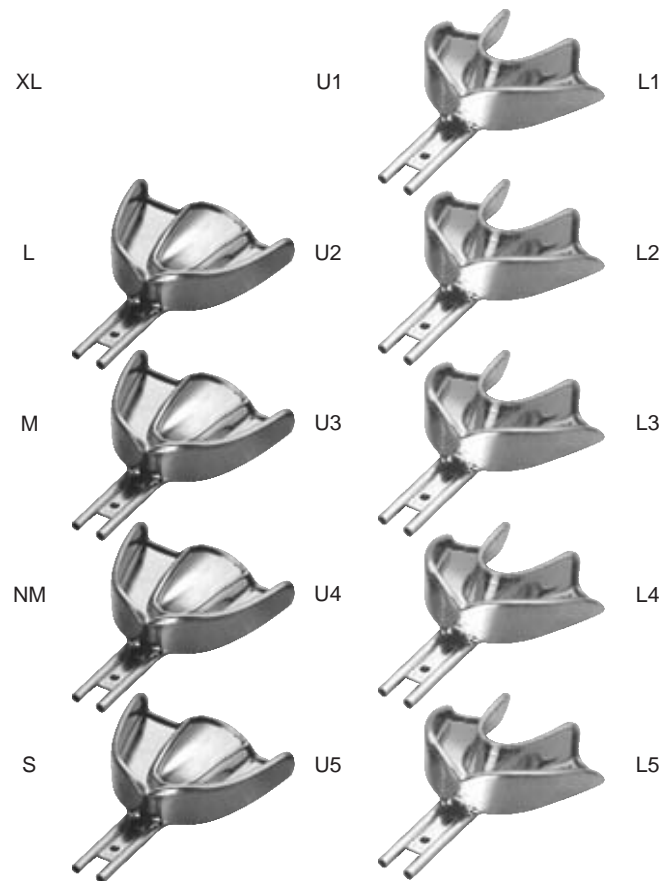

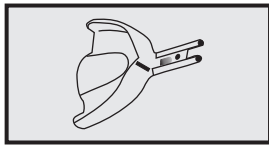

Impression Trays for partial impressions



Form C 1/2 R

Form C 1/2 R

fig.	perforated	unperforated
1	DC37-065-01	DC37-067-11
2	DC37-065-02	DC37-067-12
3	DC37-065-03	DC37-067-13
4	DC37-065-04	DC37-067-14



Form C 1/2 L

Form C 1/2 L

1	DC37-069-01	DC37-071-11
2	DC37-069-02	DC37-071-12
3	DC37-069-03	DC37-071-13
4	DC37-069-04	DC37-071-14

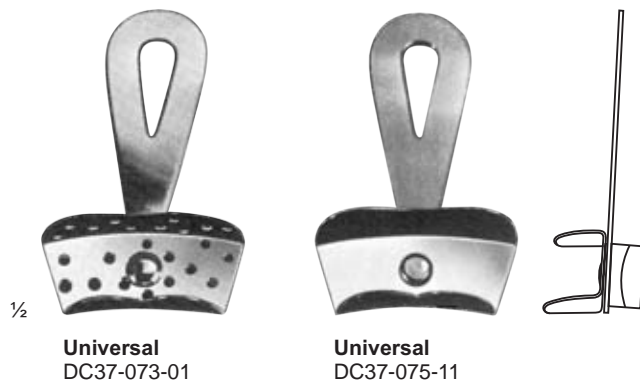

Universal
DC37-073-01

with swivel handle and fixing screw

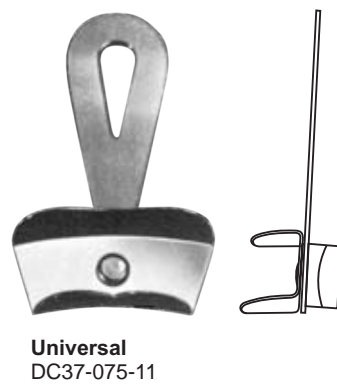

Universal
DC37-075-11



DC37-077-01

with swivel handle



DC37-079-11



Stolley
DC37-081-01

Stolley
DC37-083-11

with swivel handle and slide



Melotte
DC37-085-11

for crown work

14

DEPÓSITOS ESTÉRILES



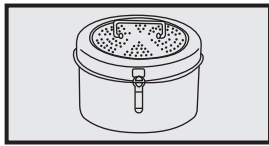

Sterilizing Boxes
Dressing Drums

∅ mm	h mm	
80	80	DC38-001-01
120	120	DC38-001-02
160	120	DC38-001-03
160	150	DC38-001-04
190	140	DC38-001-05
190	200	DC38-001-06
240	120	DC38-001-07
240	160	DC38-001-08
240	240	DC38-001-09
290	120	DC38-001-10
290	160	DC38-001-11
290	240	DC38-001-12
340	160	DC38-001-13
340	240	DC38-001-14
390	145	DC38-001-15
390	200	DC38-001-16
390	290	DC38-001-17



135 mm x 100 x 25 mm
DC38-003-25



Proper
78 mm∅x 63 mm
DC38-005-63



65 mm∅ x 15 mm
DC38-007-15



150 mm x 95 X 13 mm
DC38-009-13



150 mm x 95 X 13 mm
DC38-011-13

DC38-001-01	DC38-001-17	Dressing Sterilizing Drum
	DC38-003-25	Case for Impression Trays
	DC38-005-63	Bur-Cleaning and Storing Box
	DC38-007-15	Needle Case
DC38-009-13	DC38-011-13	Boxes and Trays for Burs

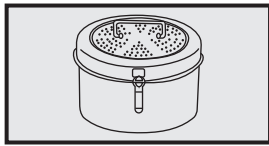

Trays & Bowls



150 mm x 95 X 13 mm
DC38-013-13



150 mm x 95 X 13 mm
DC38-015-13



150 mm x 95 X 13 mm
DC38-017-13

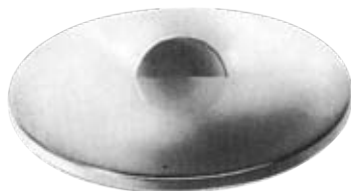

DC38-019-13



∅ 110 X 27 mm DC38-021-27
∅ 110 x 40 mm DC38-023-40



150 mm x 95 X 13 mm
DC38-025-13



150 mm x 95 X 13 mm
DC38-027-13



∅ X h	Capacity	Satin Finish	Highly Polished
116 x 50	0.35	DC38-029-50	DC38-031-50
128 x 55	0.45	DC38-029-55	DC38-031-55
147 x 65	0.7	DC38-029-65	DC38-031-65
167 x 75	1.1	DC38-029-75	DC38-031-75
187 x 85	1.6	DC38-029-85	DC38-031-85



∅ X h	Capacity	Satin Finish	Highly Polished
116 x 35	0.3	DC38-033-35	DC38-035-35
128 x 38	0.4	DC38-033-38	DC38-035-38
147 x 40	0.5	DC38-033-40	DC38-035-40
167 x 45	0.75	DC38-033-45	DC38-035-45
187 x 45	1.0	DC38-033-54	DC38-035-54

DC38-013-13	DC38-027-13	Boxes and Trays for Burs
DC38-021-27	AE 21-023-40	Multipurpose Dish
DC38-029-50	DC38-035-54	Multipurpose Bowls

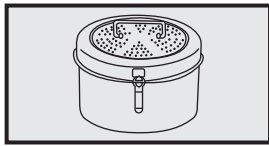

Graduated Measures



∅ x h
110 x 128 DC38-037-12



∅
100 DC38-039-10
120 DC38-039-12
150 DC38-039-15



100 cc
DC38-041-01



l x b x h	Satin Finish	Highly Polished
230 x 155 x 30	DC38-043-01	DC38-045-01
300 x 175 x 30	DC38-043-02	DC38-045-02
300 x 175 x 40	DC38-043-03	DC38-045-03
350 x 240 x 36	DC38-043-04	
400 x 300 x 50	DC38-043-05	



0.5L DC38-047-05
1.0L DC38-049-10
2.0L DC38-051-20



Dish + Lid	100 x 20 mm	DC38-053-01
Dish only	96 x 20 mm	DC38-055-09
Lid only	100 x 16 mm	DC38-057-10

Dish + Lid	100 x 20 mm	DC38-059-01
Dish only	96 x 20 mm	DC38-061-09
Lid only	100 x 16 mm	DC38-063-10



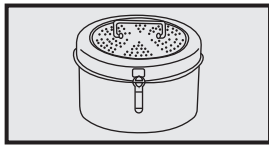

235 x 190 x 40 mm
DC38-065-40



∅ 220 x 70 mm
DC38-067-70

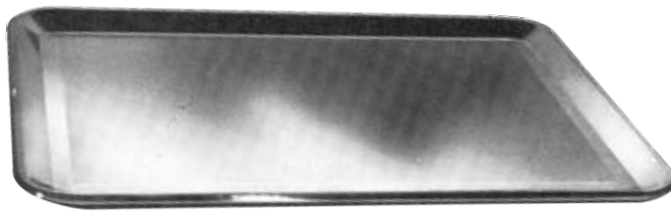

l x b x h	Satin Finish
210 x 160 x 10	DC38-069-01
240 x 180 x 10	DC38-069-02
310 x 150 x 10	DC38-069-03
310 x 210 x 10	DC38-069-04
350 x 240 x 10	DC38-069-05
350 x 240 x 20	DC38-069-06
400 x 270 x 20	DC38-069-07
420 x 280 x 10	DC38-069-08



∅ x h	Lid only	Jar without lid
30 x 90	DC38-071-01	DC38-073-01
50 x 100	DC38-071-02	DC38-073-02
50 x 130	DC38-071-03	DC38-073-03
50 x 175	DC38-071-04	DC38-073-04
75 x 100	DC38-071-05	DC38-073-05
75 x 130	DC38-071-06	DC38-073-06
75 x 175	DC38-071-07	DC38-073-07
100 x 175	DC38-071-08	DC38-073-08
100 x 200	DC38-071-09	DC38-073-09

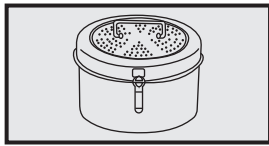

Containers for Cotton Wool
Pallets etc.
Trays for Syringe Boxes



Ø x h	With lid without knob	Lid with knob
75 x 60	DC38-075-01	DC38-077-01
75 x 75	DC38-075-02	DC38-077-02
100 x 60	DC38-075-03	DC38-077-03
100 x 100	DC38-075-04	DC38-077-04
125 x 80	DC38-075-05	DC38-077-05
125 x 125	DC38-075-06	DC38-077-06
135 x 20	DC38-075-07	DC38-077-07
135 x 35	DC38-075-08	DC38-077-08
135 x 50	DC38-075-09	DC38-077-09
135 x 100	DC38-075-10	DC38-077-10
150 x 100	DC38-075-11	DC38-077-11
150 x 150	DC38-075-12	DC38-077-12
200 x 100	DC38-075-13	DC38-077-13
200 x 150	DC38-075-14	DC38-077-14
200 x 200	DC38-075-15	DC38-077-15



205 x 105 x 40 mm
DC38-079-40



20 cc
DC38-081-20
Medicine Cup



50 cc
DC38-083-50
Medicine Cup



25 cc
DC38-085-25
Medicine Cup



l x b x h	With lid without knob	Lid with knob
165 x 85 x 35	DC38-087-01	DC38-089-01
200 x 100 x 35	DC38-087-02	DC38-089-02
200 x 100 x 50	DC38-087-03	DC38-089-03
230 x 130 x 50	DC38-087-04	DC38-089-04
260 x 150 x 50	DC38-087-05	DC38-089-05
270 x 235 x 50	DC38-087-06	DC38-089-06
300 x 200 x 50	DC38-087-07	DC38-089-07
325 x 275 x 30	DC38-087-08	DC38-089-08

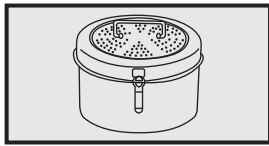

Trays



Ø 90 x 90 mm
DC38-091-90



Ø 75 x 50 mm
DC38-093-75



Ø 75 x 12 mm
DC38-095-75



250 x 115 x 15 mm
DC38-097-15



250 x 115 x 15 mm
DC38-099-25

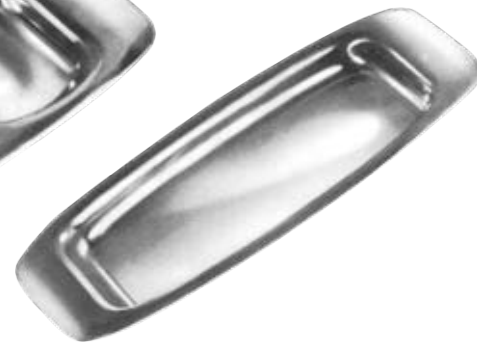

250 x 115 x 15 mm
DC38-101-52

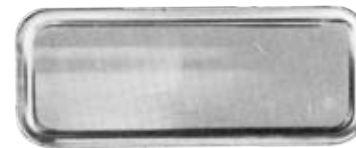
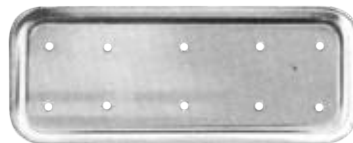

l x b x h	Perforated	Not Perforated
55 x 29 x 6	DC38-103-55	DC38-105-55
75 x 29 x 6	DC38-103-75	DC38-105-75
90 x 37 x 6	DC38-103-90	DC38-105-90

	DC38-091-90	Tumblers
	DC38-093-75	Container for Dentures
	DC38-095-75	Trays for Tablets
DC38-097-15	DC38-105-90	Trays

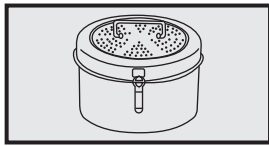

Wool Dispensers and Trays



Ø 75 x 80 mm
DC38-107-75



Ø 75 x 80 mm
DC38-109-75



Method
Ø50 x 75 mm
DC38-111-50



Ø 75 x 90 mm DC38-113-75
100 x 30 mm DC38-113-10



Ø 75 x 90 mm
DC38-115-57



I x b x h	Lid only	Bowl only
170 x 100 x 35		DC38-119-35
250 x 140 x 40	DC38-117-40	DC38-119-40
275 x 150 x 45		DC38-119-45

DC38-107-75	DC38-109-75	Sputum Cups
	DC38-111-50	Cotton Wool Holders
DC38-113-75	DC38-113-10	Cotton Wool Dispenser
	DC38-115-57	Waste Receptacle
DC38-119-35	DC38-119-45	Instrument Tray, Kidney Shaped